



SPECIFICATION FOR APPROVAL

File No.: Q/FRK 0.GS.E.C82-C07

| | |
|---------------|--|
| Product Name | Double sided metallized polypropylene film capacitor(Box-type) |
| Product Type | C82(MMKP82 Series) |
| Product Code | |
| Customer | |
| Customer Code | |
| Issue Date | 2014-10 |



Xiamen Faratronic Co. Ltd.

Add: 99 Xinyuan Road, Haicang District, Xiamen, China

Domestic business

TEL: 0592-6208620 6208618

FAX: 0592-6208777

Mail: fsc@faratronic.com.cn

michael_lai@faratronic.com.cn

Http: www.faratronic.com.cn

Export business

0086-592-6208586 6208608

0086-592-6208557

James@faratronic.com.cn

jxh@faratronic.com.cn

*.The specification are the property of Xiamen Faratronic Co,Ltd and shall not be copied or used as commercial purposes without permission.

Double sided metallized polypropylene film capacitor (Box-type)

■ Outline Drawing

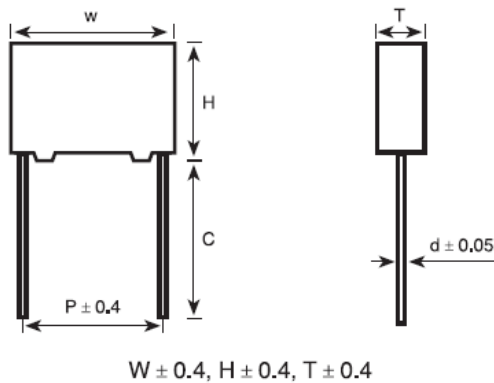

■ Features

- Double sided metallized polypropylene structure
- Low loss and small inherent temperature rise
- Negative temperature coefficient of capacitance
- Excellent active and passive flame resistant circuit

■ Typical Application

- Widely used in high voltage, high frequency and pulse circuit
- Deflection circuits in TV-sets(S-correction and fly-back tuning)and monitors
- Lamp capacitor for electronic ballast and compact lamps
- SNUBBER and SCR commutating circuits

■ Specifications

| | |
|-----------------------------|---|
| Reference Standard | GB/T 10190 (IEC 60384-16) |
| Climatic Category | 40/105/56 |
| Rated Temperature | 85°C for U_R (dc); 75°C for U_R (ac) |
| Operating Temperature Range | -40°C~105°C (+85°C to +105°C: decreasing factor 1.25% per °C for U_R (dc)) (+75°C to +105°C: decreasing factor 1.35% per °C for U_R (ac)) |
| Rated Voltage | 250V, 400V, 630V, 1 000V, 1 600V, 2 000V |
| Capacitance Range | 0.00022μF~3.9μF |
| Capacitance Tolerance | ±2% (G), ±3% (H), ±5% (J), ±10% (K), ±20% (M) |
| Voltage Proof | 1.60 U_R (5s) |
| Dissipation Factor | ≤0.0010 (1kHz, 20°C) |
| Insulation Resistance | ≥100 000MΩ, $C_N \leq 0.33\mu F$ ≥30 000s $C_N > 0.33\mu F$ (20°C, 100V, 1min) |

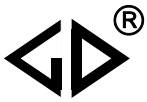

■ Part number system

The 18 digits part number is formed as follow:

| | | | | | | | | | | | | | | | | | |
|---|---|---|---|---|---|---|---|---|----|----|----|----|----|----|----|----|----|
| 1 | 2 | 3 | 4 | 5 | 6 | 7 | 8 | 9 | 10 | 11 | 12 | 13 | 14 | 15 | 16 | 17 | 18 |
| C | 8 | 2 | | | | | | | | | | | | | | | |

Digit 1 to 3 Series code

C82=MMKP82

Digit 4 to 5 D.C. rated voltage

2E=250V 2G=400V 2J=630V

3A=1000V 3C=1600V 3D=2000V

Digit 6 to 8 Rated capacitance value

For example : 103=10×10³ pF= 0.01μF

Digit 9 Capacitance tolerance

G=±2%, H=±3%

J=±5%, K=±10%, M=±20%

Digit 10 Pitch

3=7.5mm 4=10mm 6=15mm

9=22.5mm B=27.5mm

Digit 11 Internal use

Digit 12 to 15 Lead form and packaging code

Digit 16 to 18 Internal use

Table1 Lead form and packaging code

| Digit 12 | | Digit 13 | | Digit 14 | | Digit 15 | |
|----------|--|----------|-------------------------------------|----------|-------------|----------|---|
| code | explanation | code | explanation | code | explanation | code | explanation |
| A | ammo-pack | 3 | F=7.5mm | 0 | straight | 1 | Each cap. among two consecutive holes P3=12.7mm,H=18.5mm (For pitch=7.5mm) |
| | | 4 | F=10.0mm | | | 5 | P3=25.4mm,H=18.5mm (For pitch=10/15mm) |
| | | 6 | F=15.0mm | | | | |
| C | straight lead "C" in the figure above | code | explanation | 0 | | | Length tolerance ±0.5mm Or standard length |
| | | 00 | standard lead length (18mm~26mm) | | | | |
| | | 45 | lead length 4.5mm | | | | |

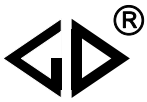

■ Dimensions(mm)

| 250Vdc(180Vac) | | | | | | |
|------------------------|-----------|-----------|-----------|-----------|------------|------------------|
| C _N (μF) | W ±0.4 | H ±0.4 | T ±0.4 | P ±0.4 | d ±0.05 | Part number |
| 0.0068 | 10.5 | 9.0 | 4.0 | 7.5 | 0.6 | C822E682-30***** |
| 0.0082 | 10.5 | 9.0 | 4.0 | 7.5 | 0.6 | C822E822-30***** |
| 0.010 | 10.5 | 9.0 | 4.0 | 7.5 | 0.6 | C822E103-30***** |
| 0.012 | 10.5 | 9.0 | 4.0 | 7.5 | 0.6 | C822E123-30***** |
| 0.015 | 10.5 | 9.0 | 4.0 | 7.5 | 0.6 | C822E153-30***** |
| 0.018 | 10.5 | 9.0 | 4.0 | 7.5 | 0.6 | C822E183-30***** |
| 0.022 | 10.5 | 9.0 | 4.0 | 7.5 | 0.6 | C822E223-30***** |
| 0.027 | 10.5 | 11.0 | 5.0 | 7.5 | 0.6 | C822E273-30***** |
| 0.033 | 10.5 | 11.0 | 5.0 | 7.5 | 0.6 | C822E333-30***** |
| 0.039 | 10.5 | 12.0 | 6.0 | 7.5 | 0.6 | C822E393-30***** |
| 0.047 | 10.5 | 12.0 | 6.0 | 7.5 | 0.6 | C822E473-30***** |
| 0.027 | 13.0 | 9.0 | 4.0 | 10.0 | 0.6 | C822E273-40***** |
| 0.033 | 13.0 | 9.0 | 4.0 | 10.0 | 0.6 | C822E333-40***** |
| 0.039 | 13.0 | 9.0 | 4.0 | 10.0 | 0.6 | C822E393-40***** |
| 0.047 | 13.0 | 11.0 | 5.0 | 10.0 | 0.6 | C822E473-40***** |
| 0.056 | 13.0 | 11.0 | 5.0 | 10.0 | 0.6 | C822E563-40***** |
| 0.068 | 13.0 | 12.0 | 6.0 | 10.0 | 0.6 | C822E683-40***** |
| 0.082 | 13.0 | 12.0 | 6.0 | 10.0 | 0.6 | C822E823-40***** |
| 0.068 | 17.5 | 11.0 | 5.0 | 15.0 | 0.8 | C822E683-60***** |
| 0.082 | 17.5 | 11.0 | 5.0 | 15.0 | 0.8 | C822E823-60***** |
| 0.10 | 17.5 | 11.0 | 5.0 | 15.0 | 0.8 | C822E104-60***** |
| 0.12 | 17.5 | 12.0 | 6.0 | 15.0 | 0.8 | C822E124-60***** |
| 0.15 | 17.5 | 12.0 | 6.0 | 15.0 | 0.8 | C822E154-60***** |
| 0.18 | 17.5 | 13.5 | 7.5 | 15.0 | 0.8 | C822E184-60***** |
| 0.22 | 17.5 | 13.5 | 7.5 | 15.0 | 0.8 | C822E224-60***** |
| 0.27 | 17.5 | 14.5 | 8.5 | 15.0 | 0.8 | C822E274-60***** |
| 0.33 | 17.5 | 16.0 | 10.0 | 15.0 | 0.8 | C822E334-60***** |
| 0.39 | 17.5 | 16.0 | 10.0 | 15.0 | 0.8 | C822E394-60***** |

| 250Vdc(180Vac) | | | | | | |
|------------------------|-----------|-----------|-----------|-----------|------------|------------------|
| C _N (μF) | W ±0.4 | H ±0.4 | T ±0.4 | P ±0.4 | d ±0.05 | Part number |
| 0.22 | 26.5 | 15.0 | 6.0 | 22.5 | 0.8 | C822E224-90***** |
| 0.27 | 26.5 | 15.0 | 6.0 | 22.5 | 0.8 | C822E274-90***** |
| 0.33 | 26.5 | 15.0 | 6.0 | 22.5 | 0.8 | C822E334-90***** |
| 0.39 | 26.5 | 16.0 | 7.0 | 22.5 | 0.8 | C822E394-90***** |
| 0.47 | 26.5 | 16.0 | 7.0 | 22.5 | 0.8 | C822E474-90***** |
| 0.56 | 26.5 | 17.0 | 8.5 | 22.5 | 0.8 | C822E564-90***** |
| 0.68 | 26.5 | 18.5 | 10.0 | 22.5 | 0.8 | C822E684-90***** |
| 0.82 | 26.5 | 18.5 | 10.0 | 22.5 | 0.8 | C822E824-90***** |
| 1.0 | 26.5 | 22.0 | 12.0 | 22.5 | 0.8 | C822E105-90***** |
| 0.82 | 32.0 | 18.0 | 9.0 | 27.5 | 0.8 | C822E824-B0***** |
| 1.0 | 32.0 | 20.0 | 11.0 | 27.5 | 0.8 | C822E105-B0***** |
| 1.2 | 32.0 | 20.0 | 11.0 | 27.5 | 0.8 | C822E125-B0***** |
| 1.5 | 32.0 | 22.0 | 13.0 | 27.5 | 0.8 | C822E155-B0***** |
| 1.8 | 32.0 | 24.5 | 15.0 | 27.5 | 0.8 | C822E185-B0***** |
| 2.2 | 32.0 | 24.5 | 15.0 | 27.5 | 0.8 | C822E225-B0***** |
| 2.7 | 32.0 | 33.0 | 18.0 | 27.5 | 0.8 | C822E275-B0***** |
| 3.3 | 32.0 | 33.0 | 18.0 | 27.5 | 0.8 | C822E335-B0***** |
| 3.9 | 32.0 | 33.0 | 18.0 | 27.5 | 0.8 | C822E395-B0***** |

Note: 1. “-”=capacitance tolerance code, M=±20%,K=±10%,J=±5%, H=±3%, G=±2%
 2. “*****”=lead form and packaging code (refer to table 1)

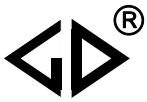

■ Dimensions(mm)

| 400Vdc(250Vac) [@] | | | | | | |
|-----------------------------|-----------|-----------|-----------|-----------|------------|------------------|
| C _N (μF) | W ±0.4 | H ±0.4 | T ±0.4 | P ±0.4 | d ±0.05 | Part number |
| 0.0027 | 10.5 | 9.0 | 4.0 | 7.5 | 0.6 | C822G272-30***** |
| 0.0033 | 10.5 | 9.0 | 4.0 | 7.5 | 0.6 | C822G332-30***** |
| 0.0039 | 10.5 | 9.0 | 4.0 | 7.5 | 0.6 | C822G392-30***** |
| 0.0047 | 10.5 | 9.0 | 4.0 | 7.5 | 0.6 | C822G472-30***** |
| 0.0056 | 10.5 | 9.0 | 4.0 | 7.5 | 0.6 | C822G562-30***** |
| 0.0068 | 10.5 | 9.0 | 4.0 | 7.5 | 0.6 | C822G682-30***** |
| 0.0082 | 10.5 | 9.0 | 4.0 | 7.5 | 0.6 | C822G822-30***** |
| 0.010 | 10.5 | 9.0 | 4.0 | 7.5 | 0.6 | C822G103-30***** |
| 0.012 | 10.5 | 9.0 | 4.0 | 7.5 | 0.6 | C822G123-30***** |
| 0.015 | 10.5 | 11.0 | 5.0 | 7.5 | 0.6 | C822G153-30***** |
| 0.018 | 10.5 | 11.0 | 5.0 | 7.5 | 0.6 | C822G183-30***** |
| 0.022 | 10.5 | 12.0 | 6.0 | 7.5 | 0.6 | C822G223-30***** |
| 0.027 | 10.5 | 12.0 | 6.0 | 7.5 | 0.6 | C822G273-30***** |
| 0.010 | 13.0 | 9.0 | 4.0 | 10.0 | 0.6 | C822G103-40***** |
| 0.012 | 13.0 | 9.0 | 4.0 | 10.0 | 0.6 | C822G123-40***** |
| 0.015 | 13.0 | 9.0 | 4.0 | 10.0 | 0.6 | C822G153-40***** |
| 0.018 | 13.0 | 9.0 | 4.0 | 10.0 | 0.6 | C822G183-40***** |
| 0.022 | 13.0 | 9.0 | 4.0 | 10.0 | 0.6 | C822G223-40***** |
| 0.027 | 13.0 | 11.0 | 5.0 | 10.0 | 0.6 | C822G273-40***** |
| 0.033 | 13.0 | 11.0 | 5.0 | 10.0 | 0.6 | C822G333-40***** |
| 0.039 | 13.0 | 12.0 | 6.0 | 10.0 | 0.6 | C822G393-40***** |
| 0.047 | 13.0 | 12.0 | 6.0 | 10.0 | 0.6 | C822G473-40***** |

| 400Vdc(250Vac) [@] | | | | | | |
|-----------------------------|-----------|-----------|-----------|-----------|------------|------------------|
| C _N (μF) | W ±0.4 | H ±0.4 | T ±0.4 | P ±0.4 | d ±0.05 | Part number |
| 0.033 | 17.5 | 11.0 | 5.0 | 15.0 | 0.8 | C822G333-60***** |
| 0.039 | 17.5 | 11.0 | 5.0 | 15.0 | 0.8 | C822G393-60***** |
| 0.047 | 17.5 | 11.0 | 5.0 | 15.0 | 0.8 | C822G473-60***** |
| 0.056 | 17.5 | 11.0 | 5.0 | 15.0 | 0.8 | C822G563-60***** |
| 0.068 | 17.5 | 12.0 | 6.0 | 15.0 | 0.8 | C822G683-60***** |
| 0.082 | 17.5 | 12.0 | 6.0 | 15.0 | 0.8 | C822G823-60***** |
| 0.10 | 17.5 | 13.5 | 7.5 | 15.0 | 0.8 | C822G104-60***** |
| 0.12 | 17.5 | 13.5 | 7.5 | 15.0 | 0.8 | C822G124-60***** |
| 0.15 | 17.5 | 14.5 | 8.5 | 15.0 | 0.8 | C822G154-60***** |
| 0.18 | 17.5 | 16.0 | 10.0 | 15.0 | 0.8 | C822G184-60***** |
| 0.22 | 17.5 | 16.0 | 10.0 | 15.0 | 0.8 | C822G224-60***** |
| 0.27 | 17.5 | 19.0 | 11.0 | 15.0 | 0.8 | C822G274-60***** |
| 0.12 | 26.5 | 15.0 | 6.0 | 22.5 | 0.8 | C822G124-90***** |
| 0.15 | 26.5 | 15.0 | 6.0 | 22.5 | 0.8 | C822G154-90***** |
| 0.18 | 26.5 | 15.0 | 6.0 | 22.5 | 0.8 | C822G184-90***** |
| 0.22 | 26.5 | 16.0 | 7.0 | 22.5 | 0.8 | C822G224-90***** |
| 0.27 | 26.5 | 17.0 | 8.5 | 22.5 | 0.8 | C822G274-90***** |
| 0.33 | 26.5 | 17.0 | 8.5 | 22.50 | 0.8 | C822G334-90***** |
| 0.39 | 26.5 | 18.5 | 10.0 | 22.5 | 0.8 | C822G394-90***** |
| 0.47 | 26.5 | 18.5 | 10.0 | 22.5 | 0.8 | C822G474-90***** |
| 0.56 | 26.5 | 22.0 | 12.0 | 22.5 | 0.8 | C822G564-90***** |
| 0.68 | 26.5 | 22.0 | 12.0 | 22.5 | 0.8 | C822G684-90***** |
| 0.39 | 32.0 | 18.0 | 9.0 | 27.5 | 0.8 | C822G394-B0***** |
| 0.47 | 32.0 | 18.0 | 9.0 | 27.5 | 0.8 | C822G474-B0***** |
| 0.56 | 32.0 | 20.0 | 11.0 | 27.5 | 0.8 | C822G564-B0***** |
| 0.68 | 32.0 | 20.0 | 11.0 | 27.5 | 0.8 | C822G684-B0***** |
| 0.82 | 32.0 | 22.0 | 13.0 | 27.5 | 0.8 | C822G824-B0***** |
| 1.0 | 32.0 | 24.5 | 15.0 | 27.5 | 0.8 | C822G105-B0***** |
| 1.2 | 32.0 | 24.5 | 15.0 | 27.5 | 0.8 | C822G125-B0***** |
| 1.5 | 32.0 | 33.0 | 18.0 | 27.5 | 0.8 | C822G155-B0***** |
| 1.8 | 32.0 | 33.0 | 18.0 | 27.5 | 0.8 | C822G185-B0***** |

- Note: 1. “-”=capacitance tolerance code, M=±20%,K=±10%,J=±5%, H=±3%, G=±2%
 2. “*****”=lead form and packaging code (refer to table 1)
 3. “@” Not suitable for across-the-line applications. Pls refer to the Interference Suppression Capacitor.



■ Dimensions(mm)

| 630Vdc(400Vac) | | | | | | |
|------------------------|-----------|-----------|-----------|-----------|------------|------------------|
| C _N (μF) | W ±0.4 | H ±0.4 | T ±0.4 | P ±0.4 | d ±0.05 | Part number |
| 0.00068 | 10.5 | 9.0 | 4.0 | 7.5 | 0.6 | C822J681-30***** |
| 0.00082 | 10.5 | 9.0 | 4.0 | 7.5 | 0.6 | C822J821-30***** |
| 0.0010 | 10.5 | 9.0 | 4.0 | 7.5 | 0.6 | C822J102-30***** |
| 0.0012 | 10.5 | 9.0 | 4.0 | 7.5 | 0.6 | C822J122-30***** |
| 0.0015 | 10.5 | 9.0 | 4.0 | 7.5 | 0.6 | C822J152-30***** |
| 0.0018 | 10.5 | 9.0 | 4.0 | 7.5 | 0.6 | C822J182-30***** |
| 0.0022 | 10.5 | 9.0 | 4.0 | 7.5 | 0.6 | C822J222-30***** |
| 0.0027 | 10.5 | 9.0 | 4.0 | 7.5 | 0.6 | C822J272-30***** |
| 0.0033 | 10.5 | 9.0 | 4.0 | 7.5 | 0.6 | C822J332-30***** |
| 0.0039 | 10.5 | 9.0 | 4.0 | 7.5 | 0.6 | C822J392-30***** |
| 0.0047 | 10.5 | 9.0 | 4.0 | 7.5 | 0.6 | C822J472-30***** |
| 0.0056 | 10.5 | 9.0 | 4.0 | 7.5 | 0.6 | C822J562-30***** |
| 0.0068 | 10.5 | 11.0 | 5.0 | 7.5 | 0.6 | C822J682-30***** |
| 0.0082 | 10.5 | 11.0 | 5.0 | 7.5 | 0.6 | C822J822-30***** |
| 0.010 | 10.5 | 12.0 | 6.0 | 7.5 | 0.6 | C822J103-30***** |
| 0.012 | 10.5 | 12.0 | 6.0 | 7.5 | 0.6 | C822J123-30***** |
| 0.0039 | 13.0 | 9.0 | 4.0 | 10.0 | 0.6 | C822J392-40***** |
| 0.0047 | 13.0 | 9.0 | 4.0 | 10.0 | 0.6 | C822J472-40***** |
| 0.0056 | 13.0 | 9.0 | 4.0 | 10.0 | 0.6 | C822J562-40***** |
| 0.0068 | 13.0 | 9.0 | 4.0 | 10.0 | 0.6 | C822J682-40***** |
| 0.0082 | 13.0 | 9.0 | 4.0 | 10.0 | 0.6 | C822J822-40***** |
| 0.010 | 13.0 | 11.0 | 5.0 | 10.0 | 0.6 | C822J103-40***** |
| 0.012 | 13.0 | 11.0 | 5.0 | 10.0 | 0.6 | C822J123-40***** |
| 0.015 | 13.0 | 12.0 | 6.0 | 10.0 | 0.6 | C822J153-40***** |
| 0.018 | 13.0 | 12.0 | 6.0 | 10.0 | 0.6 | C822J183-40***** |
| 0.012 | 17.5 | 11.0 | 5.0 | 15.0 | 0.8 | C822J123-60***** |
| 0.015 | 17.5 | 11.0 | 5.0 | 15.0 | 0.8 | C822J153-60***** |
| 0.018 | 17.5 | 11.0 | 5.0 | 15.0 | 0.8 | C822J183-60***** |
| 0.022 | 17.5 | 11.0 | 5.0 | 15.0 | 0.8 | C822J223-60***** |
| 0.027 | 17.5 | 11.0 | 5.0 | 15.0 | 0.8 | C822J273-60***** |
| 0.033 | 17.5 | 12.0 | 6.0 | 15.0 | 0.8 | C822J333-60***** |

| 630Vdc(400Vac) | | | | | | |
|------------------------|-----------|-----------|-----------|-----------|------------|------------------|
| C _N (μF) | W ±0.4 | H ±0.4 | T ±0.4 | P ±0.4 | d ±0.05 | Part number |
| 0.039 | 17.5 | 12.0 | 6.0 | 15.0 | 0.8 | C822J393-60***** |
| 0.047 | 17.5 | 12.0 | 6.0 | 15.0 | 0.8 | C822J473-60***** |
| 0.056 | 17.5 | 13.5 | 7.5 | 15.0 | 0.8 | C822J563-60***** |
| 0.068 | 17.5 | 14.5 | 8.5 | 15.0 | 0.8 | C822J683-60***** |
| 0.082 | 17.5 | 14.5 | 8.5 | 15.0 | 0.8 | C822J823-60***** |
| 0.10 | 17.5 | 16.0 | 10.0 | 15.0 | 0.8 | C822J104-60***** |
| 0.12 | 17.5 | 19.0 | 11.0 | 15.0 | 0.8 | C822J124-60***** |
| 0.047 | 26.5 | 15.0 | 6.0 | 22.5 | 0.8 | C822J473-90***** |
| 0.056 | 26.5 | 15.0 | 6.0 | 22.5 | 0.8 | C822J563-90***** |
| 0.068 | 26.5 | 15.0 | 6.0 | 22.5 | 0.8 | C822J683-90***** |
| 0.082 | 26.5 | 15.0 | 6.0 | 22.5 | 0.8 | C822J823-90***** |
| 0.10 | 26.5 | 15.0 | 6.0 | 22.5 | 0.8 | C822J104-90***** |
| 0.12 | 26.5 | 16.0 | 7.0 | 22.5 | 0.8 | C822J124-90***** |
| 0.15 | 26.5 | 17.0 | 8.5 | 22.5 | 0.8 | C822J154-90***** |
| 0.18 | 26.5 | 17.0 | 8.5 | 22.5 | 0.8 | C822J184-90***** |
| 0.22 | 26.5 | 18.5 | 10.0 | 22.5 | 0.8 | C822J224-90***** |
| 0.27 | 26.5 | 22.0 | 12.0 | 22.5 | 0.8 | C822J274-90***** |
| 0.33 | 26.5 | 22.0 | 12.0 | 22.5 | 0.8 | C822J334-90***** |
| 0.39 | 26.5 | 22.0 | 12.0 | 22.5 | 0.8 | C822J394-90***** |
| 0.15 | 32.0 | 18.0 | 9.0 | 27.5 | 0.8 | C822J154-B0***** |
| 0.18 | 32.0 | 18.0 | 9.0 | 27.5 | 0.8 | C822J184-B0***** |
| 0.22 | 32.0 | 18.0 | 9.0 | 27.5 | 0.8 | C822J224-B0***** |
| 0.27 | 32.0 | 18.0 | 9.0 | 27.5 | 0.8 | C822J274-B0***** |
| 0.33 | 32.0 | 20.0 | 11.0 | 27.5 | 0.8 | C822J334-B0***** |
| 0.39 | 32.0 | 20.0 | 11.0 | 27.5 | 0.8 | C822J394-B0***** |
| 0.47 | 32.0 | 22.0 | 13.0 | 27.5 | 0.8 | C822J474-B0***** |
| 0.56 | 32.0 | 22.0 | 13.0 | 27.5 | 0.8 | C822J564-B0***** |
| 0.68 | 32.0 | 24.5 | 15.0 | 27.5 | 0.8 | C822J684-B0***** |
| 0.82 | 32.0 | 28.0 | 14.0 | 27.5 | 0.8 | C822J824-B0***** |
| 1.0 | 32.0 | 33.0 | 18.0 | 27.5 | 0.8 | C822J105-B0***** |
| 1.2 | 32.0 | 33.0 | 18.0 | 27.5 | 0.8 | C822J125-B0***** |

Note: 1. “-”=capacitance tolerance code, M=±20%,K=±10%,J=±5%, H=±3%, G=±2%

2. “*****”=lead form and packaging code (refer to table 1)



■ Dimensions(mm)

| 1 000Vdc(600Vac) | | | | | | |
|------------------------|-----------|-----------|-----------|-----------|------------|--------------------|
| C _N (μF) | W ±0.4 | H ±0.4 | T ±0.4 | P ±0.4 | d ±0.05 | Part number |
| 0.00047 | 10.5 | 9.0 | 4.0 | 7.5 | 0.6 | C823A471-30****+++ |
| 0.00056 | 10.5 | 9.0 | 4.0 | 7.5 | 0.6 | C823A561-30****+++ |
| 0.00068 | 10.5 | 9.0 | 4.0 | 7.5 | 0.6 | C823A681-30****+++ |
| 0.00082 | 10.5 | 9.0 | 4.0 | 7.5 | 0.6 | C823A821-30****+++ |
| 0.0010 | 10.5 | 9.0 | 4.0 | 7.5 | 0.6 | C823A102-30****+++ |
| 0.0012 | 10.5 | 11.0 | 5.0 | 7.5 | 0.6 | C823A122-30****+++ |
| 0.0015 | 10.5 | 11.0 | 5.0 | 7.5 | 0.6 | C823A152-30****+++ |
| 0.0018 | 10.5 | 11.0 | 5.0 | 7.5 | 0.6 | C823A182-30****+++ |
| 0.0022 | 10.5 | 11.0 | 5.0 | 7.5 | 0.6 | C823A222-30****+++ |
| 0.0027 | 10.5 | 12.0 | 6.0 | 7.5 | 0.6 | C823A272-30****+++ |
| 0.0033 | 10.5 | 12.0 | 6.0 | 7.5 | 0.6 | C823A332-30****+++ |
| 0.0010 | 13.0 | 9.0 | 4.0 | 10.0 | 0.6 | C823A102-40****+++ |
| 0.0012 | 13.0 | 9.0 | 4.0 | 10.0 | 0.6 | C823A122-40****+++ |
| 0.0015 | 13.0 | 9.0 | 4.0 | 10.0 | 0.6 | C823A152-40****+++ |
| 0.0018 | 13.0 | 9.0 | 4.0 | 10.0 | 0.6 | C823A182-40****+++ |
| 0.0022 | 13.0 | 9.0 | 4.0 | 10.0 | 0.6 | C823A222-40****+++ |
| 0.0027 | 13.0 | 9.0 | 4.0 | 10.0 | 0.6 | C823A272-40****+++ |
| 0.0033 | 13.0 | 9.0 | 4.0 | 10.0 | 0.6 | C823A332-40****+++ |
| 0.0039 | 13.0 | 11.0 | 5.0 | 10.0 | 0.6 | C823A392-40****+++ |
| 0.0047 | 13.0 | 11.0 | 5.0 | 10.0 | 0.6 | C823A472-40****+++ |
| 0.0056 | 13.0 | 12.0 | 6.0 | 10.0 | 0.6 | C823A562-40****+++ |
| 0.0068 | 13.0 | 12.0 | 6.0 | 10.0 | 0.6 | C823A682-40****+++ |

| 1 000Vdc(600Vac) | | | | | | |
|------------------------|-----------|-----------|-----------|-----------|------------|--------------------|
| C _N (μF) | W ±0.4 | H ±0.4 | T ±0.4 | P ±0.4 | d ±0.05 | Part number |
| 0.0082 | 17.5 | 11.0 | 5.0 | 15.0 | 0.8 | C823A822-60****+++ |
| 0.010 | 17.5 | 11.0 | 5.0 | 15.0 | 0.8 | C823A103-60****+++ |
| 0.012 | 17.5 | 11.0 | 5.0 | 15.0 | 0.8 | C823A123-60****+++ |
| 0.015 | 17.5 | 11.0 | 5.0 | 15.0 | 0.8 | C823A153-60****+++ |
| 0.018 | 17.5 | 13.5 | 7.5 | 15.0 | 0.8 | C823A183-60****+++ |
| 0.022 | 17.5 | 13.5 | 7.5 | 15.0 | 0.8 | C823A223-60****+++ |
| 0.027 | 17.5 | 14.5 | 8.5 | 15.0 | 0.8 | C823A273-60****+++ |
| 0.033 | 17.5 | 14.5 | 8.5 | 15.0 | 0.8 | C823A333-60****+++ |
| 0.039 | 17.5 | 16.0 | 10.0 | 15.0 | 0.8 | C823A393-60****+++ |
| 0.047 | 17.5 | 19.0 | 11.0 | 15.0 | 0.8 | C823A473-60****+++ |
| 0.027 | 26.5 | 15.0 | 6.0 | 22.5 | 0.8 | C823A273-90****+++ |
| 0.033 | 26.5 | 15.0 | 6.0 | 22.5 | 0.8 | C823A333-90****+++ |
| 0.039 | 26.5 | 15.0 | 6.0 | 22.5 | 0.8 | C823A393-90****+++ |
| 0.047 | 26.5 | 16.0 | 7.0 | 22.5 | 0.8 | C823A473-90****+++ |
| 0.056 | 26.5 | 16.0 | 7.0 | 22.5 | 0.8 | C823A563-90****+++ |
| 0.068 | 26.5 | 17.0 | 8.5 | 22.5 | 0.8 | C823A683-90****+++ |
| 0.082 | 26.5 | 18.5 | 10.0 | 22.5 | 0.8 | C823A823-90****+++ |
| 0.10 | 26.5 | 18.5 | 10.0 | 22.5 | 0.8 | C823A104-90****+++ |
| 0.12 | 26.5 | 22.0 | 12.0 | 22.5 | 0.8 | C823A124-90****+++ |
| 0.15 | 26.5 | 22.0 | 12.0 | 22.5 | 0.8 | C823A154-90****+++ |
| 0.10 | 32.0 | 18.0 | 9.0 | 27.5 | 0.8 | C823A104-B0****+++ |
| 0.12 | 32.0 | 20.0 | 11.0 | 27.5 | 0.8 | C823A124-B0****+++ |
| 0.15 | 32.0 | 20.0 | 11.0 | 27.5 | 0.8 | C823A154-B0****+++ |
| 0.18 | 32.0 | 22.0 | 13.0 | 27.5 | 0.8 | C823A184-B0****+++ |
| 0.22 | 32.0 | 22.0 | 13.0 | 27.5 | 0.8 | C823A224-B0****+++ |
| 0.27 | 32.0 | 24.5 | 15.0 | 27.5 | 0.8 | C823A274-B0****+++ |
| 0.33 | 32.0 | 28.0 | 14.0 | 27.5 | 0.8 | C823A334-B0****+++ |
| 0.39 | 32.0 | 33.0 | 18.0 | 27.5 | 0.8 | C823A394-B0****+++ |
| 0.47 | 32.0 | 33.0 | 18.0 | 27.5 | 0.8 | C823A474-B0****+++ |

Note: 1. “-”=capacitance tolerance code, M=±20%,K=±10%,J=±5%, H=±3%, G=±2%

2. “****”=lead form and packaging code (refer to table 1)



■ Dimensions(mm)

| 1 600Vdc(650Vac) | | | | | | |
|------------------------|-----------|-----------|-----------|-----------|------------|--------------------|
| C _N (μF) | W ±0.4 | H ±0.4 | T ±0.4 | P ±0.4 | d ±0.05 | Part number |
| 0.00068 | 17.5 | 11.0 | 5.0 | 15.0 | 0.8 | C823C681-60****+++ |
| 0.00082 | 17.5 | 11.0 | 5.0 | 15.0 | 0.8 | C823C821-60****+++ |
| 0.0010 | 17.5 | 11.0 | 5.0 | 15.0 | 0.8 | C823C102-60****+++ |
| 0.0012 | 17.5 | 11.0 | 5.0 | 15.0 | 0.8 | C823C122-60****+++ |
| 0.0015 | 17.5 | 11.0 | 5.0 | 15.0 | 0.8 | C823C152-60****+++ |
| 0.0018 | 17.5 | 11.0 | 5.0 | 15.0 | 0.8 | C823C182-60****+++ |
| 0.0022 | 17.5 | 11.0 | 5.0 | 15.0 | 0.8 | C823C222-60****+++ |
| 0.0027 | 17.5 | 11.0 | 5.0 | 15.0 | 0.8 | C823C272-60****+++ |
| 0.0033 | 17.5 | 11.0 | 5.0 | 15.0 | 0.8 | C823C332-60****+++ |
| 0.0039 | 17.5 | 11.0 | 5.0 | 15.0 | 0.8 | C823C392-60****+++ |
| 0.0047 | 17.5 | 11.0 | 5.0 | 15.0 | 0.8 | C823C472-60****+++ |
| 0.0056 | 17.5 | 11.0 | 5.0 | 15.0 | 0.8 | C823C562-60****+++ |
| 0.0068 | 17.5 | 11.0 | 5.0 | 15.0 | 0.8 | C823C682-60****+++ |
| 0.0082 | 17.5 | 12.0 | 6.0 | 15.0 | 0.8 | C823C822-60****+++ |
| 0.010 | 17.5 | 12.0 | 6.0 | 15.0 | 0.8 | C823C103-60****+++ |
| 0.012 | 17.5 | 13.5 | 7.5 | 15.0 | 0.8 | C823C123-60****+++ |
| 0.015 | 17.5 | 13.5 | 7.5 | 15.0 | 0.8 | C823C153-60****+++ |
| 0.018 | 17.5 | 14.5 | 8.5 | 15.0 | 0.8 | C823C183-60****+++ |
| 0.022 | 17.5 | 14.5 | 8.5 | 15.0 | 0.8 | C823C223-60****+++ |
| 0.027 | 17.5 | 16.0 | 10.0 | 15.0 | 0.8 | C823C273-60****+++ |
| 0.033 | 17.5 | 19.0 | 11.0 | 15.0 | 0.8 | C823C333-60****+++ |

| 1 600Vdc(650Vac) | | | | | | |
|------------------------|-----------|-----------|-----------|-----------|------------|--------------------|
| C _N (μF) | W ±0.4 | H ±0.4 | T ±0.4 | P ±0.4 | d ±0.05 | Part number |
| 0.015 | 26.5 | 15.0 | 6.0 | 22.5 | 0.8 | C823C153-90****+++ |
| 0.018 | 26.5 | 15.0 | 6.0 | 22.5 | 0.8 | C823C183-90****+++ |
| 0.022 | 26.5 | 15.0 | 6.0 | 22.5 | 0.8 | C823C223-90****+++ |
| 0.027 | 26.5 | 15.0 | 6.0 | 22.5 | 0.8 | C823C273-90****+++ |
| 0.033 | 26.5 | 16.0 | 7.0 | 22.5 | 0.8 | C823C333-90****+++ |
| 0.039 | 26.5 | 17.0 | 8.5 | 22.5 | 0.8 | C823C393-90****+++ |
| 0.047 | 26.5 | 18.5 | 10.0 | 22.5 | 0.8 | C823C473-90****+++ |
| 0.056 | 26.5 | 18.5 | 10.0 | 22.5 | 0.8 | C823C563-90****+++ |
| 0.068 | 26.5 | 22.0 | 12.0 | 22.5 | 0.8 | C823C683-90****+++ |
| 0.082 | 26.5 | 22.0 | 12.0 | 22.5 | 0.8 | C823C823-90****+++ |
| 0.039 | 32.0 | 18.0 | 9.0 | 27.5 | 0.8 | C823C393-B0****+++ |
| 0.047 | 32.0 | 18.0 | 9.0 | 27.5 | 0.8 | C823C473-B0****+++ |
| 0.056 | 32.0 | 18.0 | 9.0 | 27.5 | 0.8 | C823C563-B0****+++ |
| 0.068 | 32.0 | 18.0 | 9.0 | 27.5 | 0.8 | C823C683-B0****+++ |
| 0.082 | 32.0 | 20.0 | 11.0 | 27.5 | 0.8 | C823C823-B0****+++ |
| 0.10 | 32.0 | 20.0 | 11.0 | 27.5 | 0.8 | C823C104-B0****+++ |
| 0.12 | 32.0 | 22.0 | 13.0 | 27.5 | 0.8 | C823C124-B0****+++ |
| 0.15 | 32.0 | 24.5 | 15.0 | 27.5 | 0.8 | C823C154-B0****+++ |
| 0.18 | 32.0 | 24.5 | 15.0 | 27.5 | 0.8 | C823C184-B0****+++ |
| 0.22 | 32.0 | 33.0 | 18.0 | 27.5 | 0.8 | C823C224-B0****+++ |
| 0.27 | 32.0 | 33.0 | 18.0 | 27.5 | 0.8 | C823C274-B0****+++ |
| 0.33 | 32.0 | 33.0 | 18.0 | 27.5 | 0.8 | C823C334-B0****+++ |

Note: 1. “-”=capacitance tolerance code, M=±20%, K=±10%, J=±5%, H=±3%, G=±2%

2. “****”=lead form and packaging code (refer to table 1)

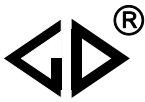

■ Dimensions(mm)

| 2 000Vdc(700Vac) | | | | | | |
|------------------------|-----------|-----------|-----------|-----------|------------|------------------|
| C _N (μF) | W ±0.4 | H ±0.4 | T ±0.4 | P ±0.4 | d ±0.05 | Part number |
| 0.00022 | 17.5 | 11.0 | 5.0 | 15.0 | 0.8 | C823D221-60***** |
| 0.00027 | 17.5 | 11.0 | 5.0 | 15.0 | 0.8 | C823D271-60***** |
| 0.00033 | 17.5 | 11.0 | 5.0 | 15.0 | 0.8 | C823D331-60***** |
| 0.00039 | 17.5 | 11.0 | 5.0 | 15.0 | 0.8 | C823D391-60***** |
| 0.00047 | 17.5 | 11.0 | 5.0 | 15.0 | 0.8 | C823D471-60***** |
| 0.00056 | 17.5 | 11.0 | 5.0 | 15.0 | 0.8 | C823D561-60***** |
| 0.00068 | 17.5 | 11.0 | 5.0 | 15.0 | 0.8 | C823D681-60***** |
| 0.00082 | 17.5 | 11.0 | 5.0 | 15.0 | 0.8 | C823D821-60***** |
| 0.0010 | 17.5 | 11.0 | 5.0 | 15.0 | 0.8 | C823D102-60***** |
| 0.0012 | 17.5 | 11.0 | 5.0 | 15.0 | 0.8 | C823D122-60***** |
| 0.0015 | 17.5 | 11.0 | 5.0 | 15.0 | 0.8 | C823D152-60***** |
| 0.0018 | 17.5 | 11.0 | 5.0 | 15.0 | 0.8 | C823D182-60***** |
| 0.0022 | 17.5 | 11.0 | 5.0 | 15.0 | 0.8 | C823D222-60***** |
| 0.0027 | 17.5 | 11.0 | 5.0 | 15.0 | 0.8 | C823D272-60***** |
| 0.0033 | 17.5 | 12.0 | 6.0 | 15.0 | 0.8 | C823D332-60***** |
| 0.0039 | 17.5 | 12.0 | 6.0 | 15.0 | 0.8 | C823D392-60***** |
| 0.0047 | 17.5 | 12.0 | 6.0 | 15.0 | 0.8 | C823D472-60***** |
| 0.0056 | 17.5 | 13.5 | 7.5 | 15.0 | 0.8 | C823D562-60***** |
| 0.0068 | 17.5 | 13.5 | 7.5 | 15.0 | 0.8 | C823D682-60***** |
| 0.0082 | 17.5 | 14.5 | 8.5 | 15.0 | 0.8 | C823D822-60***** |
| 0.010 | 17.5 | 16.0 | 10.0 | 15.0 | 0.8 | C823D103-60***** |
| 0.012 | 17.5 | 16.0 | 10.0 | 15.0 | 0.8 | C823D123-60***** |
| 0.015 | 17.5 | 19.0 | 11.0 | 15.0 | 0.8 | C823D153-60***** |

| 2 000Vdc(700Vac) | | | | | | |
|------------------------|-----------|-----------|-----------|-----------|------------|------------------|
| C _N (μF) | W ±0.4 | H ±0.4 | T ±0.4 | P ±0.4 | d ±0.05 | Part number |
| 0.0010 | 26.5 | 15.0 | 6.0 | 22.5 | 0.8 | C823D102-90***** |
| 0.0012 | 26.5 | 15.0 | 6.0 | 22.5 | 0.8 | C823D122-90***** |
| 0.0015 | 26.5 | 15.0 | 6.0 | 22.5 | 0.8 | C823D152-90***** |
| 0.0018 | 26.5 | 15.0 | 6.0 | 22.5 | 0.8 | C823D182-90***** |
| 0.0022 | 26.5 | 15.0 | 6.0 | 22.5 | 0.8 | C823D222-90***** |
| 0.0027 | 26.5 | 15.0 | 6.0 | 22.5 | 0.8 | C823D272-90***** |
| 0.0033 | 26.5 | 15.0 | 6.0 | 22.5 | 0.8 | C823D332-90***** |
| 0.0039 | 26.5 | 15.0 | 6.0 | 22.5 | 0.8 | C823D392-90***** |
| 0.0047 | 26.5 | 15.0 | 6.0 | 22.5 | 0.8 | C823D472-90***** |
| 0.0056 | 26.5 | 15.0 | 6.0 | 22.5 | 0.8 | C823D562-90***** |
| 0.0068 | 26.5 | 15.0 | 6.0 | 22.5 | 0.8 | C823D682-90***** |
| 0.0082 | 26.5 | 15.0 | 6.0 | 22.5 | 0.8 | C823D822-90***** |
| 0.010 | 26.5 | 15.0 | 6.0 | 22.5 | 0.8 | C823D103-90***** |
| 0.012 | 26.5 | 15.0 | 6.0 | 22.5 | 0.8 | C823D123-90***** |
| 0.015 | 26.5 | 16.0 | 7.0 | 22.5 | 0.8 | C823D153-90***** |
| 0.018 | 26.5 | 16.0 | 7.0 | 22.5 | 0.8 | C823D183-90***** |
| 0.022 | 26.5 | 17.0 | 8.5 | 22.5 | 0.8 | C823D223-90***** |
| 0.027 | 26.5 | 18.5 | 10.0 | 22.5 | 0.8 | C823D273-90***** |
| 0.033 | 26.5 | 18.5 | 10.0 | 22.5 | 0.8 | C823D333-90***** |
| 0.039 | 26.5 | 22.0 | 12.0 | 22.5 | 0.8 | C823D393-90***** |
| 0.047 | 26.5 | 22.0 | 12.0 | 22.5 | 0.8 | C823D473-90***** |
| 0.022 | 32.0 | 18.0 | 9.0 | 27.5 | 0.8 | C823D223-B0***** |
| 0.027 | 32.0 | 18.0 | 9.0 | 27.5 | 0.8 | C823D273-B0***** |
| 0.033 | 32.0 | 18.0 | 9.0 | 27.5 | 0.8 | C823D333-B0***** |
| 0.039 | 32.0 | 20.0 | 11.0 | 27.5 | 0.8 | C823D393-B0***** |
| 0.047 | 32.0 | 20.0 | 11.0 | 27.5 | 0.8 | C823D473-B0***** |
| 0.056 | 32.0 | 22.0 | 13.0 | 27.5 | 0.8 | C823D563-B0***** |
| 0.068 | 32.0 | 22.0 | 13.0 | 27.5 | 0.8 | C823D683-B0***** |
| 0.082 | 32.0 | 24.5 | 15.0 | 27.5 | 0.8 | C823D823-B0***** |
| 0.10 | 32.0 | 28.0 | 14.0 | 27.5 | 0.8 | C823D104-B0***** |
| 0.12 | 32.0 | 33.0 | 18.0 | 27.5 | 0.8 | C823D124-B0***** |
| 0.15 | 32.0 | 33.0 | 18.0 | 27.5 | 0.8 | C823D154-B0***** |

Note: 1. “-”=capacitance tolerance code, M=±20%,K=±10%,J=±5%, H=±3%, G=±2%

2. “*****”=lead form and packaging code (refer to table 1)

■ Maximum permissible voltage change per unit of time

| Rated Voltage (V) | Max dV/dt(V/us) | | | | |
|-------------------|-----------------|--------|--------|----------|----------|
| | P=7.5mm | P=10mm | P=15mm | P=22.5mm | P=27.5mm |
| 250 | 1200 | 1000 | 550 | 250 | 200 |
| 400 | 1800 | 1500 | 900 | 500 | 300 |
| 630 | 3200 | 3200 | 2500 | 1500 | 900 |
| 1000 | 6000 | 6000 | 3300 | 2100 | 1000 |
| 1600 | \ | \ | 6000 | 3000 | 2000 |
| 2000 | \ | \ | 10000 | 5000 | 2200 |

Note: 1. Rated voltage pulse slope (dV/dt)_R at rated voltage.

2. If the working voltage(U) is lower than the rated voltage(U_R),the capacitor can be worked at a higher dV/dt. In this case, the maximum allowed dV/dt is obtain by multiplying the right value with U_R/U.

■ MAX. VOLTAGE(Vr.m.s) VERSUS FREQUENCY

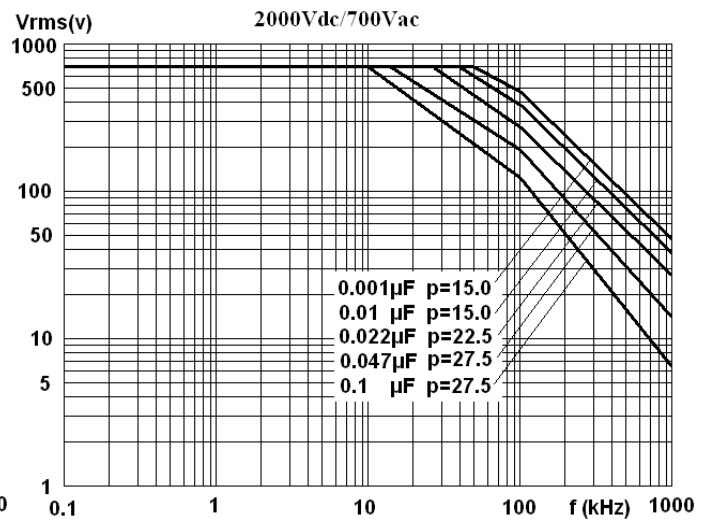
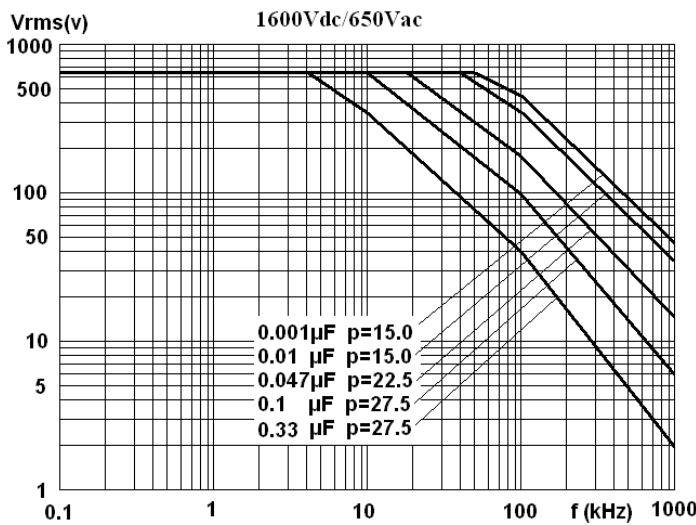
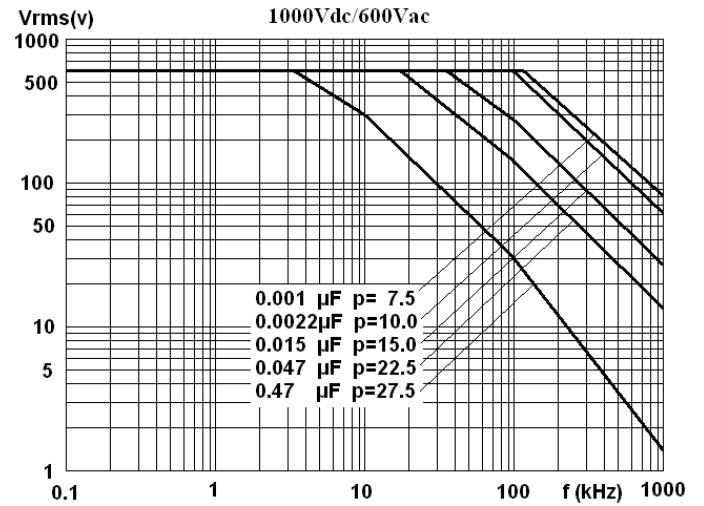
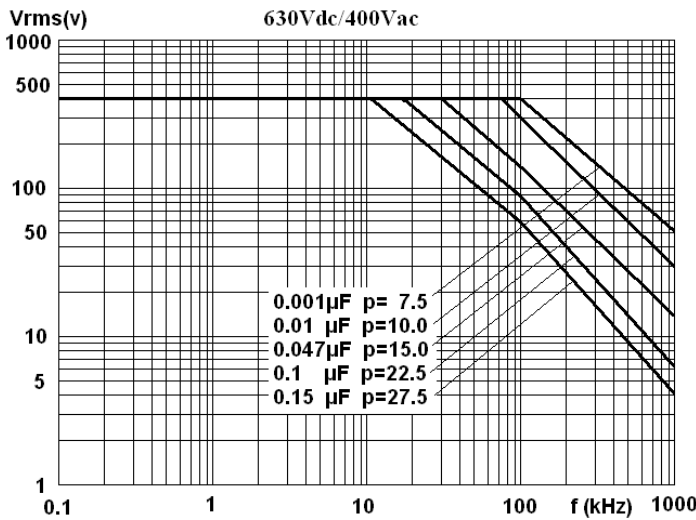
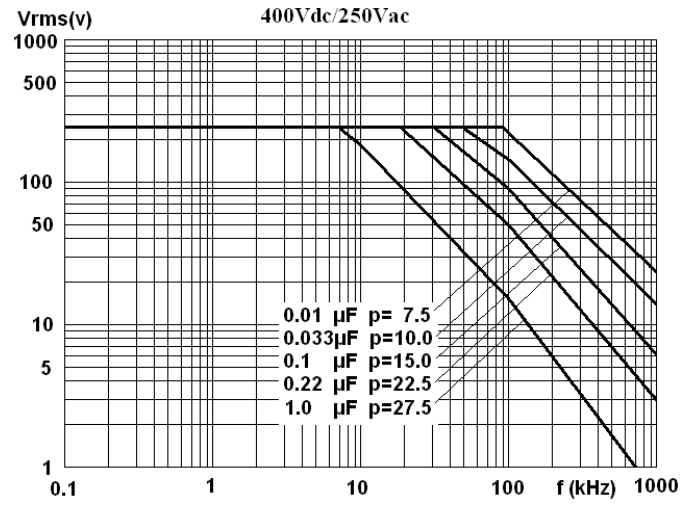
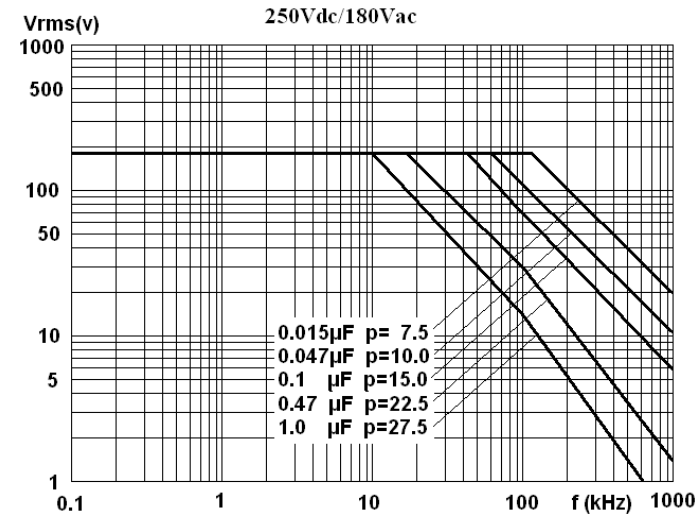

Note: sinusoidal wave-form, environment temperature $\leq 85^{\circ}\text{C}$, internal temperature rise $\Delta T = 10^{\circ}\text{C}$, p (pitch) in mm..

■ MAX. CURRENT(Ir.m.s) VERSUS FREQUENCY

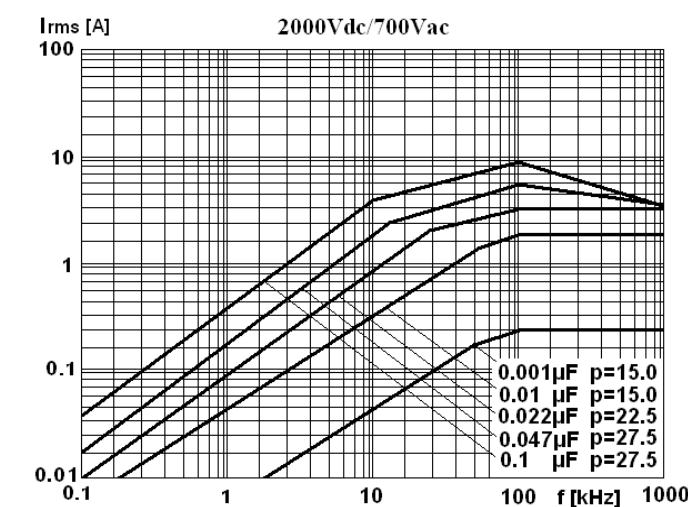
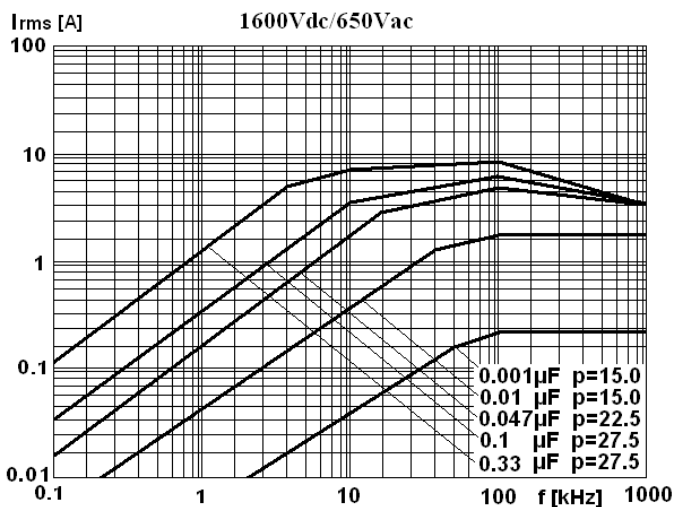
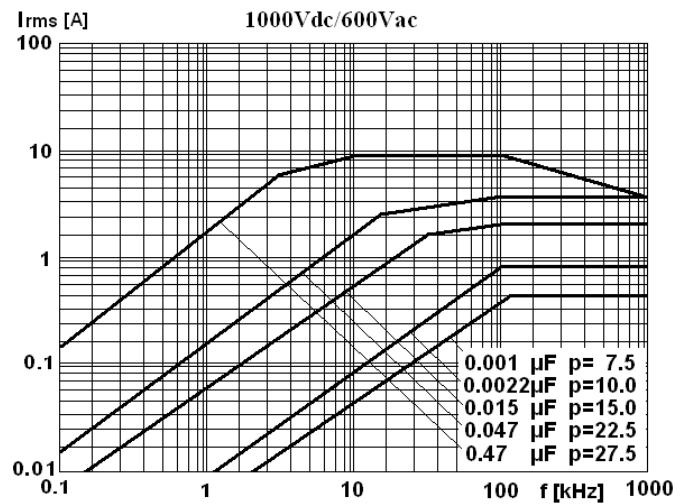
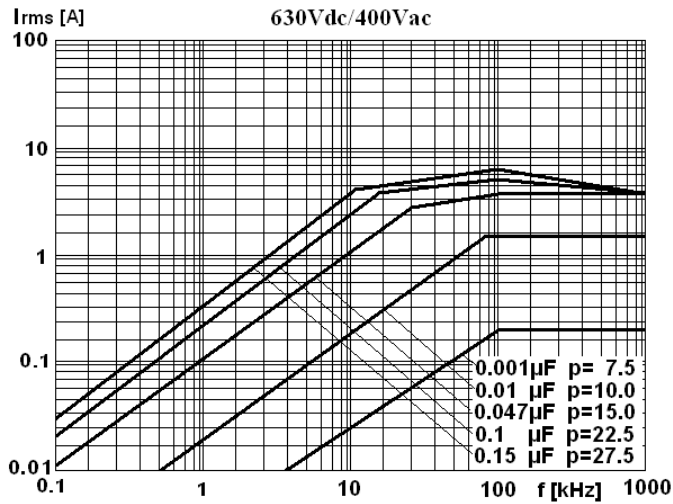
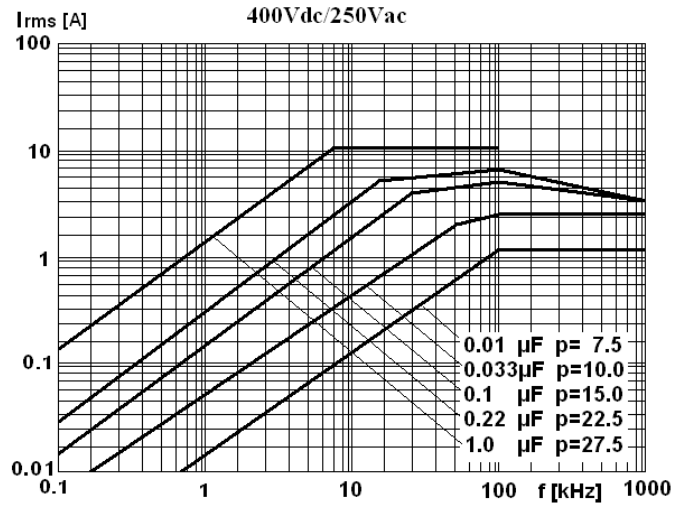
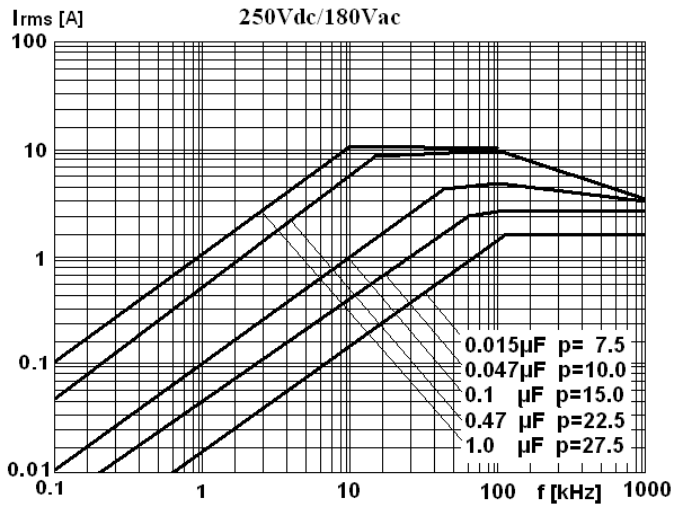

Note: sinusoidal wave-form, environment temperature $\leq 85^{\circ}\text{C}$, internal temperature rise $\Delta T = 10^{\circ}\text{C}$, p (pitch) in mm.

■ Test Method And Performance

| No. | Item | Performance | Test method(IEC 60384-16) | |
|-----|-----------------------------|--|--|--|
| 1 | Solderability | Good quality of tinning | Solder temperature: 245°C ±5°C Immersion time: 2.0s±0.5s | |
| 2 | Initial measurement | Capacitance Tgδ: 1kHz, C>1.0μF 10kHz, C≤1.0μF | | |
| | Terminal strength | There shall be no visible damage | Tense: 0.50<d≤0.80, 10N 0.80<d≤1.25, 20N Bend: 0.50<d≤0.80, 5N 0.80<d≤1.25, 10N The terminals shall be bent 2 times in each direction | |
| | Resistance to solder heat | There shall be no visible damage, legible marking | Solder temperature:260°C±5°C Immersion time: 10s±1s | |
| | Final measurement | ΔC/C ≤±2%(relative to the initial value) Increase of tgδ: ≤0.002 (10kHz,C≤1.0μF) ≤0.002 (1kHz, C>1.0μF) | | |
| 3 | Initial measurement | Capacitance Tgδ(10kHz) | | |
| | Rapid change of temperature | There shall be no evidence of deterioration. | θ _A =-40°C, θ _B =+105°C 5 cycles Duration: t=30min | |
| | Vibration | There shall be no evidence of deterioration. | Amplitude 0.75mm or acceleration 98m/s ² (whichever is the smaller severity), f: 10Hz to 500Hz.Three directions, 2h for each direction, total 6h. | |
| | Bump | There shall be no evidence of deterioration. | 4 000 times, Acceleration: 390m/s ² ,Pulse duration, 6ms | |
| | Final measurement | There shall be no visible damage ΔC/C ≤±2%(relative to the initial value) Increase of tgδ: ≤0.002 (10kHz) IR: ≥ 50% of the rated value | | |
| 4 | Climate sequence | Initial measurement | Capacitance Tgδ: 10kHz | |
| | | Dry heat | +105°C, 16h | |
| | | Damp heat, Cyclic | Test Db, Severity: b, the first cycle | |
| | | Cold | -40°C, 2h | |
| | | Low air pressure | There shall be no permanent breakdown, flashover or other harmful deformation when applying U _R at the last 1 minute. | 15°C~35°C, 8.5kPa, 1h |
| | | Damp heat, cyclic other | Applying U _R for 1 minute after 15 minutes the test finished . | Test Db, Severity b, the other cycles, |
| | | Final measurement | There shall be no visible damage, legible marking ΔC/C ≤±3%(relative to the initial value) Increase of tgδ:≤0.003(10kHz) I.R.: ≥ 50% of the rated value | |

| No. | Item | Performance | Test method(IEC 60384-16) |
|-----|----------------------------|--|---|
| 5 | Damp heat steady state | There shall be no visible damage, legible marking $\Delta C/C \leq \pm 5\%$ (relative to the initial value) Increase of $\text{tg}\delta: \leq 0.002$ (10kHz) I.R.: $\geq 50\%$ of the rated value | Temperature: $40^\circ\text{C} \pm 2^\circ\text{C}$ Humidity: $93 \pm 2\%$ RH Duration: 56 days |
| 6 | Endurance | There shall be no visible damage, legible marking $\Delta C/C \leq \pm 5\%$ (relative to the initial value) Increase of $\text{tg}\delta: \leq 0.0015$ (10kHz) I.R.: $\geq 50\%$ of the rated value | Temperature: $+85^\circ\text{C}$ Voltage: $1.25 \times U_R$ (50Hz) Duration: 1 000h |
| 7 | Temperature characteristic | Measuring capacitance at test point b, d, f: Characteristic at lower category temperature -40°C : $0 \leq (C_b - C_d)/C_d \leq +3\%$ Characteristic at upper category temperature $+105^\circ\text{C}$: $-4\% \leq (C_f - C_d)/C_d \leq 0$ I.R. (test at point f): $IR \geq 2500\text{M}\Omega$ $C_R \leq 0.33 \mu\text{F}$ $IR \geq 750\text{s}$ $C_R > 0.33 \mu\text{F}$ | Static method: The Capacitors should be kept at the following temperature in turn: a(20 ± 2) $^\circ\text{C}$, b(-40 ± 3) $^\circ\text{C}$, d(20 ± 2) $^\circ\text{C}$, f(105 ± 2) $^\circ\text{C}$, g(20 ± 2) $^\circ\text{C}$ |
| 8 | Charging and discharging | $\Delta C/C \leq \pm 5\%$ (relative to the initial value) increase of $\text{tg}\delta: \leq 0.005$ (10kHz) I.R.: $\geq 50\%$ of the rated value | Times: 10 000 Duration of charging: 0.5s Duration of discharging: 0.5s Charging voltage: rated voltage U_R Charging resistance: $220/C_R(\Omega)$ Discharging resistance: $U_R \div C_R \div dV/dt(\Omega)$ C_R : rated capacitance (μF) dV/dt value: see page 9 table |
| 9 | Passive flammability | The flaming time of each capacitor shall not go beyond 30s after it is taken apart from the flame. Drop of each capacitor caused by flame shall not fire the tissue below | IEC 695-2-2 Needle flame test The category of passive flammability: C, Expose time in flame : 1 time Capacitor volume Exposing time $V \leq 250\text{mm}^3$ 5s $250\text{mm}^3 < V \leq 500\text{mm}^3$ 10s $500\text{mm}^3 < V \leq 1750\text{mm}^3$ 20s $V > 1750\text{mm}^3$ 30s |

■ Quality ensuring test (before shipment):

| Inspection item (each batch) | Inspection level (GB 2828) | |
|------------------------------|----------------------------|-------|
| | IL | AQL |
| Appearance inspection | II | 1.5% |
| Dimensions | | |
| Capacitance | II | 0.65% |
| Tangent of the loss angle | | |
| Dielectric strength | | |
| Insulation resistance | | |
| Solderability | S-3 | 2.5% |

■ Marking

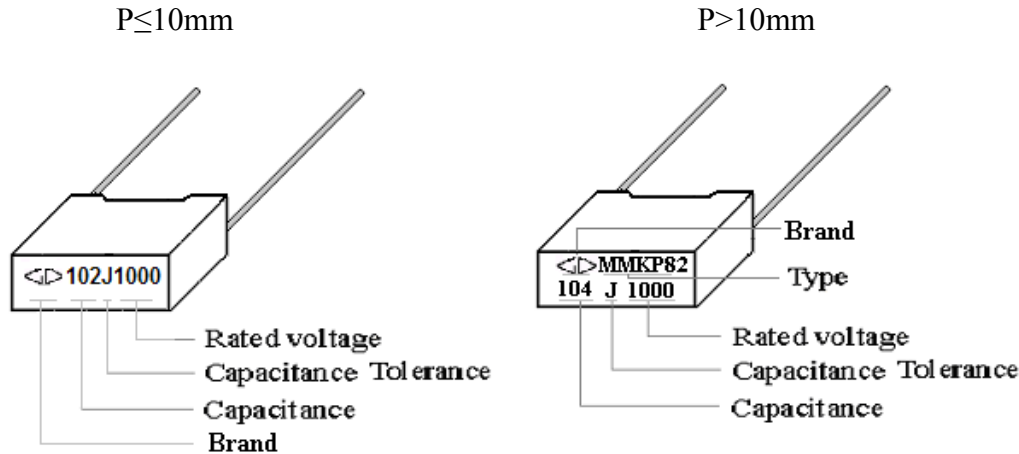

■ Taping specification for box-type capacitors

▲ Outline Drawing

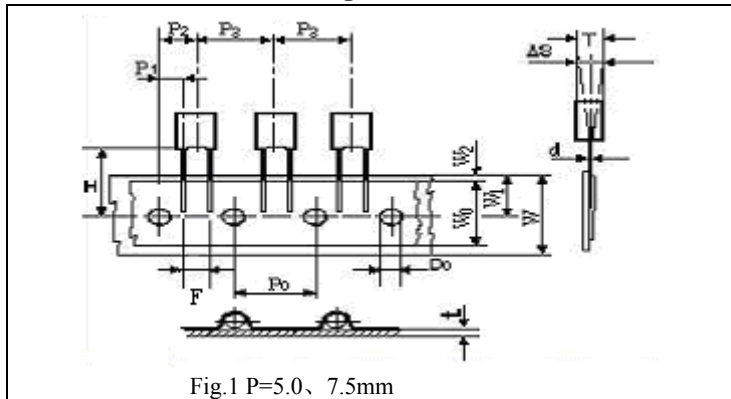

Fig.1 P=5.0、7.5mm

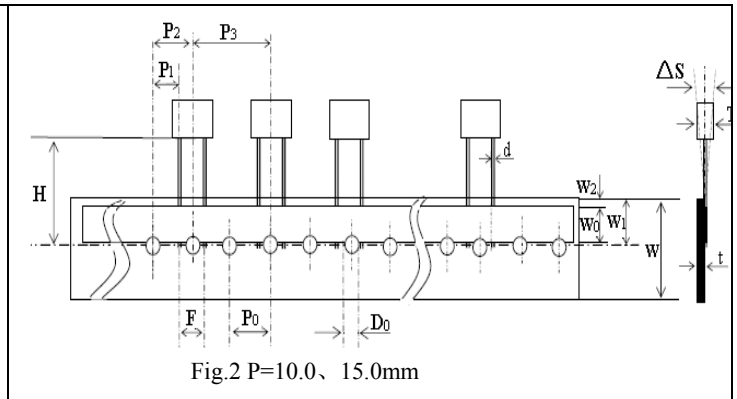

Fig.2 P=10.0、15.0mm

▲ Taping Dimensions(mm)

| Technology index title | Code | Dimensions | | | | Tolerance |
|--------------------------------------|----------------|------------|-------|--------|--------|--------------|
| | | P=5.0 | P=7.5 | P=10.0 | P=15.0 | |
| Taping type | — | Fig 1 | Fig 1 | Fig2 | Fig 2 | — |
| Part number Digit12-15 | Ammo-pack | A201 | A301 | A405 | A605 | |
| Taping pitch | P ₃ | 12.7 | 12.7 | 25.4 | 25.4 | ±1.0 |
| Feed hole pitch | P ₀ | 12.7 | 12.7 | 12.7 | 12.7 | ±0.2 |
| Center of wire | P ₁ | 3.85 | 2.6 | 7.7 | 5.2 | ±0.7 |
| Center of body | P ₂ | 6.35 | 6.35 | 12.7 | 12.7 | ±1.3 |
| Pitch of taping wire | F** | 5.0 | 7.5 | 10.0 | 15.0 | +0.6 -0.1 |
| Component alignment | ΔS | 0 | 0 | 0 | 0 | ±2.0 |
| Height of component from tape center | H*** | 18.5 | 18.5 | 18.5 | 18.5 | ±0.5 |
| Carrier tape width | W | 18.0 | 18.0 | 18.0 | 18.0 | +1.0 -0.5 |
| Hold down tape width | W ₀ | 6min | 10min | 10min | 10min | — |
| Hole position | W ₁ | 9.0 | 9.0 | 9.0 | 9.0 | ±0.5 |
| Hold down tape position | W ₂ | 3max | 3max | 3max | 3max | — |
| Feed hole dia. | D ₀ | 4.0 | 4.0 | 4.0 | 4.0 | ±0.2 |
| Tape thickness | t | 0.7 | 0.7 | 0.7 | 0.9 | ±0.2 |

▲ Packing Quantity

| Pitch (mm) | Box thickness T(mm) | Ammo-pack (pcs/box) | |
|---------------|---------------------|---------------------|--------|
| | | Domestic | Export |
| 5.0 | 2.5 | 2500 | 2 000 |
| | 3.5 | 1 700 | 1 500 |
| | 4.5 | 1 400 | 1 300 |
| | 5.0 | 1 200 | 1 000 |
| 7.5 | 6.0 | 1 000 | 800 |
| | 3.5 | 1 700 | 1 500 |
| | 4.0 | 1 500 | 1 300 |
| | 5.0 | 1 200 | 1 000 |
| 10.0/ 15.0 | 6.0 | 1 000 | 800 |
| | 4.0 | 750 | 650 |
| | 5.0 | 600 | 500 |
| 15.0 | 6.0 | 500 | 450 |
| | 7.5 | 400 | 350 |
| | 8.5 | 350 | 300 |
| | 10.0 | 300 | 250 |
| | 11.0 | 250 | 200 |

Note: * P₀=15mm is also available;

**F can be other lead spacing;

***H=16.5mm is available;

■ Packing box sizes(mm)

1. Out packing box for bulk

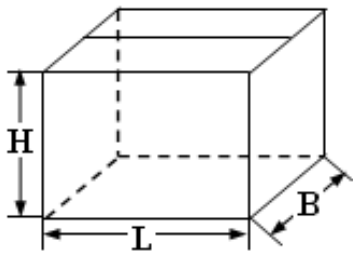

L:375±5
B:375±5
H:265±5

2. Inner packing box for bulk

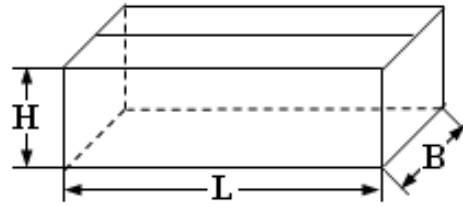

L:355±3
B:175±3
H:118±3

3. Box sizes for Ammo-pack

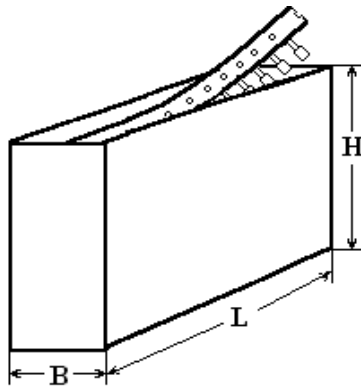

L:330±3
B:48±3
H:260±3