

Technical Document

FD 1225 12 B 35



December 2015, Brussels

Features

Parameter	Units	Specifications
Dimensions	mm	120x120x25
Weight	gram	125
Power Supply	VDC	12
Current	A	0.35
Power Input	W	4.2
Speed	RPM	3500
Air Flow	cfm	106.4
Static Pressure	mmH ₂ O	7.36
Sound Level	dba	47.2
Operating Temp.	°C	-10~+70
Life	hours	70000
Bearing	-	Ball bearing
Housing Material	-	UL 94-0 rating thermoplastic
Impeller Material	-	UL 94-0 rating thermoplastic
Electrical Connection	-	Lead wires (L)
Polarity Protection	-	Open circuit when Vcc and GND are exchanged.
Certifications	-	CE

*: above specifications are subject to change without prior notice

Dimensions

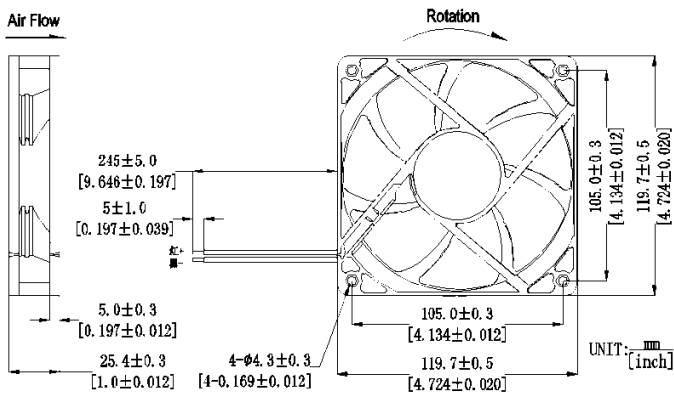

Performance

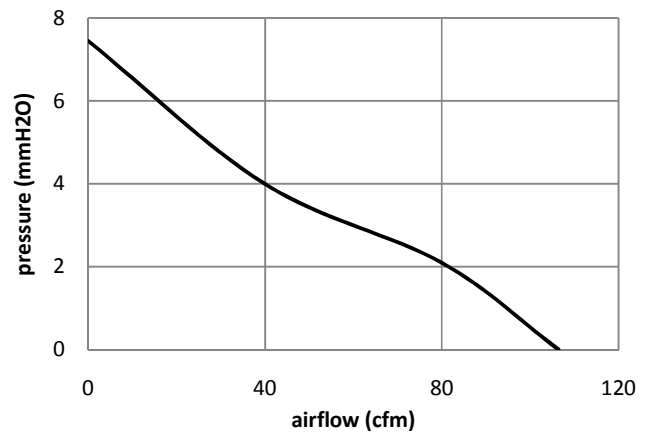

Ordering Code:

Model	Part Number	Description
FD1225 12 B 35	200229	DC120x120x25 fan, 3500 rpm, ball bearing, lead wires