



Insertion Loss: 1-100MHZ -1.0dB MAX

Return Loss: 1-30MHZ -18.0dB MIN
 30-60MHZ -16.0dB MIN
 60-80MHZ -12.0dB MIN

Cross Talk: 1-30MHZ -40.0dB MIN
 30-60MHZ -35.0dB MIN
 60-80MHZ -30.0dB MIN

CMR: 1-100MHZ -30.0dB MIN

Hi-Pot: 1500v AC 60S 1mA

Turn Ratio: 1CT:1CT+/-3%

OCL:400uH MIN @ 100KHZ 100mV 8mA DC

Contacts: 0.35mm thick phos bronze plated with 6u' gold in contact are

Housing Material: PBT Black

Operating temperature range:0°C to +70°C

Schematics

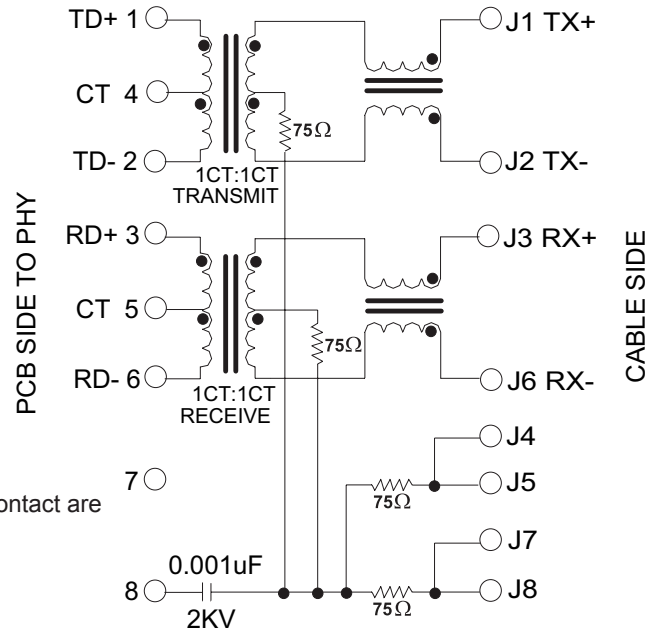

ELECTRICAL SPECIFICATIONS @ 25°C unless otherwise noted:

Mechanical

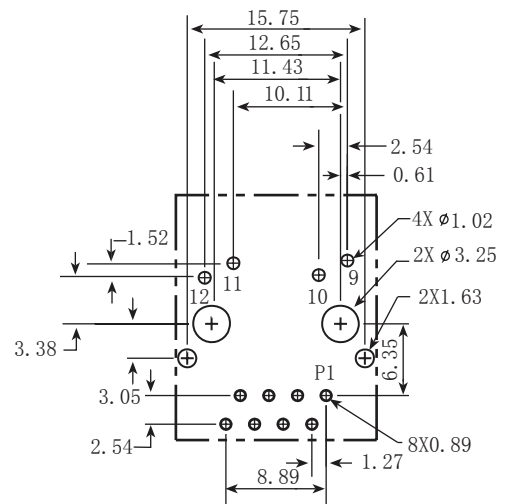
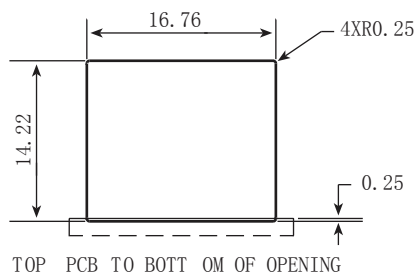
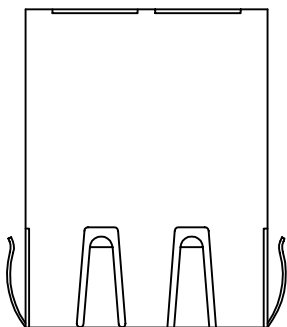
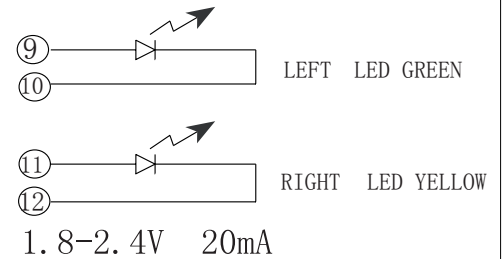
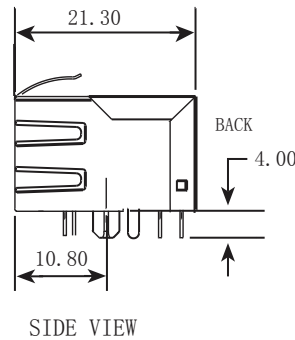
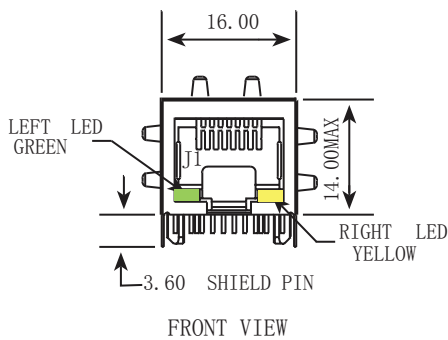

Viewed from PCB Component side

Tel: 86-574-86828566		KLS ELECTRONIC CO., LTD.					
http://www.klsele.com							
单位(units)	MM	设计(draw)	邓辉剑	材料 (mt'1)	图名 (name)		10/100BASE 1x1Tab-Down RJ45
比例 (scale)	1 : 1	审核 (ch'k)	朱建华	UNIT:mm	.xx +/-0.25, xxx +/-0.13		
版次 (rev.)	A / 1	核准 (app'd)	朱建华	HOUSING	PBT	料号 (Part number)	L-KLS12-TL002R-1X1-G/Y-1-03
视图 (view)		日期 (date)	2008.08.12	PIN	Qsn6.5-0.1	图档 (File Name)	E:\工程图