

Trench™ Power MOSFETs

N-Channel Enhancement Mode

IXTA76N25T
IXTP76N25T
IXTQ76N25T
IXTH76N25T

V_{DSS} = 250V
I_{D25} = 76A
R_{DS(on)} ≤ 42mΩ

Typical Avalanche BV = 300V

TO-263 AA (IXTA)

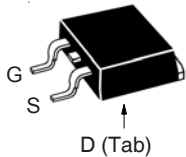

TO-220AB (IXTP)

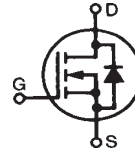
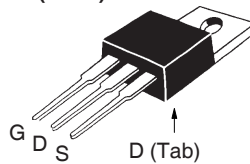

TO-3P (IXTQ)

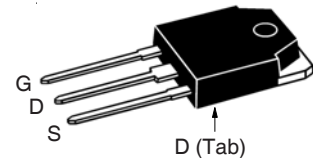

TO-247(IXTH)

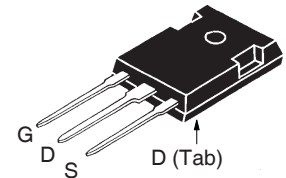

G = Gate D = Drain
S = Source Tab = Drain

Symbol	Test Conditions	Maximum Ratings	
V _{DSS}	T _J = 25°C to 150°C	250	V
V _{DGR}	T _J = 25°C to 150°C, R _{GS} = 1MΩ	250	V
V _{GSS}	Continuous	± 20	V
V _{GSM}	Transient	± 30	V
I _{D25}	T _C = 25°C	76	A
I _{DM}	T _C = 25°C, Pulse Width Limited by T _{JM}	170	A
I _A	T _C = 25°C	8	A
E _{AS}	T _C = 25°C	1.5	J
P _D	T _C = 25°C	460	W
T _J		-55 ... +150	°C
T _{JM}		150	°C
T _{stg}		-55 ... +150	°C
T _L	Maximum Lead Temperature for Soldering	300	°C
T _{SOLD}	Plastic Body for 10s	260	°C
F _C	Mounting Force (TO-263)	10..65 / 2.2..14.6	N/lb.
M _d	Mounting Torque (TO-220, TO-3P & TO-247)	1.13/10	Nm/lb.in.
Weight	TO-263	2.5	g
	TO-220	3.0	g
	TO-3P	5.5	g
	TO-247	6.0	g

Features

- Avalanche Rated
- High Current Handling Capability
- Fast Intrinsic Rectifier
- Low R_{DS(on)}

Advantages

- Easy to Mount
- Space Savings
- High Power Density

Applications

- DC-DC Converters
- Battery Chargers
- Switch-Mode and Resonant-Mode Power Supplies
- DC Choppers
- AC Motor Drives
- Uninterruptible Power Supplies
- High Speed Power Switching Applications

Symbol	Test Conditions (T _J = 25°C, Unless Otherwise Specified)	Characteristic Values		
		Min.	Typ.	Max.
BV _{DSS}	V _{GS} = 0V, I _D = 1mA	250		V
	V _{GS} = 0V, I _D = 10mA		300	V
V _{GS(th)}	V _{DS} = V _{GS} , I _D = 250μA	3.0		5.0 V
I _{GSS}	V _{GS} = ± 20V, V _{DS} = 0V			± 100 nA
I _{DSS}	V _{DS} = V _{DSS} , V _{GS} = 0V T _J = 125°C			2 μA
				200 μA
R _{DS(on)}	V _{GS} = 10V, I _D = 0.5 • I _{D25} , Note 1			42 mΩ

Symbol	Test Conditions ($T_J = 25^\circ\text{C}$ Unless Otherwise Specified)	Characteristic Values		
		Min.	Typ.	Max.
g_{fs}	$V_{DS} = 10\text{V}, I_D = 0.5 \cdot I_{D25}$, Note 1	43	72	S
C_{iss}	$V_{GS} = 0\text{V}, V_{DS} = 25\text{V}, f = 1\text{MHz}$		4920	pF
C_{oss}			470	pF
C_{rss}			70	pF
$t_{d(on)}$	Resistive Switching Times $V_{GS} = 15\text{V}, V_{DS} = 0.5 \cdot V_{DSS}, I_D = 0.5 \cdot I_{D25}$ $R_G = 3.3\Omega$ (External)		22	ns
t_r			25	ns
$t_{d(off)}$			56	ns
t_f			29	ns
$Q_{g(on)}$	$V_{GS} = 10\text{V}, V_{DS} = 0.5 \cdot V_{DSS}, I_D = 25\text{A}$		92	nC
Q_{gs}			28	nC
Q_{gd}			21	nC
R_{thJC}				0.27 °C/W
R_{thCH}	TO-220		0.50	°C/W
	TO-3P & TO-247		0.25	°C/W

Source-Drain Diode

Symbol	Test Conditions ($T_J = 25^\circ\text{C}$ Unless Otherwise Specified)	Characteristic Values		
		Min.	Typ.	Max.
I_S	$V_{GS} = 0\text{V}$			76 A
I_{SM}	Repetitive, Pulse Width Limited by T_{JM}			200 A
V_{SD}	$I_F = I_S, V_{GS} = 0\text{V}$, Note 1			1.5 V
t_{rr}	$I_F = 38\text{A}, -di/dt = 250\text{A}/\mu\text{s}$ $V_R = 100\text{V}, V_{GS} = 0\text{V}$		148	ns
I_{RM}			21	A
Q_{RM}			1.6	μC

Note 1: Pulse test, $t \leq 300\mu\text{s}$, duty cycle, $d \leq 2\%$.

IXYS Reserves the Right to Change Limits, Test Conditions, and Dimensions.

IXYS MOSFETs and IGBTs are covered by one or more of the following U.S. patents:	4,835,592	4,931,844	5,049,961	5,237,481	6,162,665	6,404,065 B1	6,683,344	6,727,585	7,005,734 B2	7,157,338B2
	4,860,072	5,017,508	5,063,307	5,381,025	6,259,123 B1	6,534,343	6,710,405 B2	6,759,692	7,063,975 B2	
	4,881,106	5,034,796	5,187,117	5,486,715	6,306,728 B1	6,583,505	6,710,463	6,771,478 B2	7,071,537	

TO-263 Outline

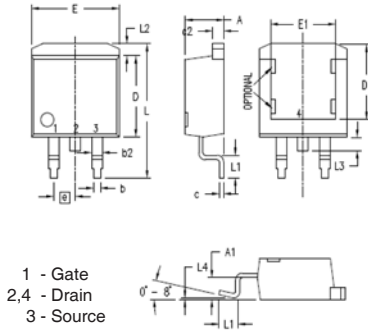

SYM	INCHES		MILLIMETERS	
	MIN	MAX	MIN	MAX
A	.160	.190	4.06	4.83
A1	.080	.110	2.03	2.79
b	.020	.039	0.51	0.99
b2	.045	.055	1.14	1.40
c	.016	.029	0.40	0.74
c2	.045	.055	1.14	1.40
D	.340	.380	8.64	9.65
D1	.315	.350	8.00	8.89
E	.380	.410	9.65	10.41
E1	.245	.320	6.22	8.13
e	.100 BSC		2.54 BSC	
L	.575	.625	14.61	15.88
L1	.090	.110	2.29	2.79
L2	.040	.055	1.02	1.40
L3	.050	.070	1.27	1.78
L4	0	.005	0	0.13

TO-220 Outline

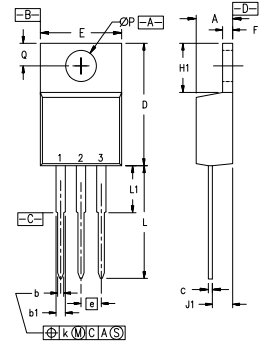

Pins: 1 - Gate 2 - Drain
3 - Source

SYM	INCHES		MILLIMETERS	
	MIN	MAX	MIN	MAX
A	.170	.190	4.32	4.83
b	.025	.040	0.64	1.02
b1	.045	.065	1.15	1.65
c	.014	.022	0.35	0.56
D	.580	.630	14.73	16.00
E	.390	.420	9.91	10.66
e	.100 BSC		2.54 BSC	
F	.045	.055	1.14	1.40
H1	.230	.270	5.85	6.85
J1	.090	.110	2.29	2.79
k	0	.015	0	0.38
L	.500	.550	12.70	13.97
L1	.110	.230	2.79	5.84
ØP	.139	.161	3.53	4.08
Q	.100	.125	2.54	3.18

TO-247 Outline

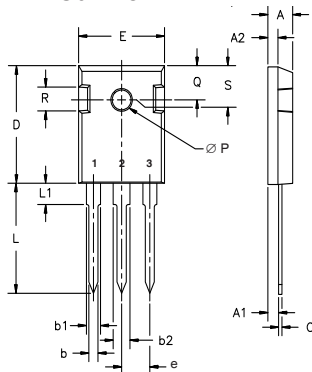

Terminals: 1 - Gate 2 - Drain
3 - Source

Dim.	Millimeter		Inches	
	Min.	Max.	Min.	Max.
A	4.7	5.3	.185	.209
A ₁	2.2	2.54	.087	.102
A ₂	2.2	2.6	.059	.098
b	1.0	1.4	.040	.055
b ₁	1.65	2.13	.065	.084
b ₂	2.87	3.12	.113	.123
C	.4	.8	.016	.031
D	20.80	21.46	.819	.845
E	15.75	16.26	.610	.640
e	5.20	5.72	0.205	0.225
L	19.81	20.32	.780	.800
L1		4.50		.177
ØP	3.55	3.65	.140	.144
Q	5.89	6.40	0.232	0.252
R	4.32	5.49	.170	.216
S		6.15 BSC		242 BSC

TO-3P Outline

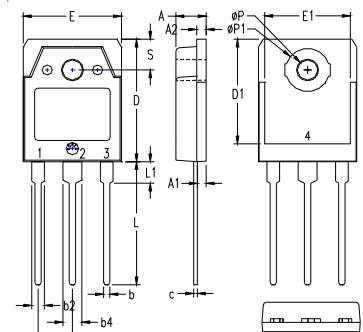

1 - GATE
2 - DRAIN (COLLECTOR)
3 - SOURCE (EMITTER)
4 - DRAIN (COLLECTOR)

SYM	INCHES		MILLIMETERS	
	MIN	MAX	MIN	MAX
A	.185	.193	4.70	4.90
A1	.051	.059	1.30	1.50
A2	.057	.065	1.45	1.65
b	.035	.045	0.90	1.15
b2	.075	.087	1.90	2.20
b4	.114	.126	2.90	3.20
c	.022	.031	0.55	0.80
D	.780	.799	19.80	20.30
D1	.665	.677	16.90	17.20
E	.610	.622	15.50	15.80
E1	.531	.539	13.50	13.70
e	.215 BSC		5.45 BSC	
L	.779	.795	19.80	20.20
L1	.134	.142	3.40	3.60
ØP	.126	.134	3.20	3.40
ØP1	.272	.280	6.90	7.10
S	.193	.201	4.90	5.10

Fig. 1. Output Characteristics @ $T_J = 25^\circ\text{C}$

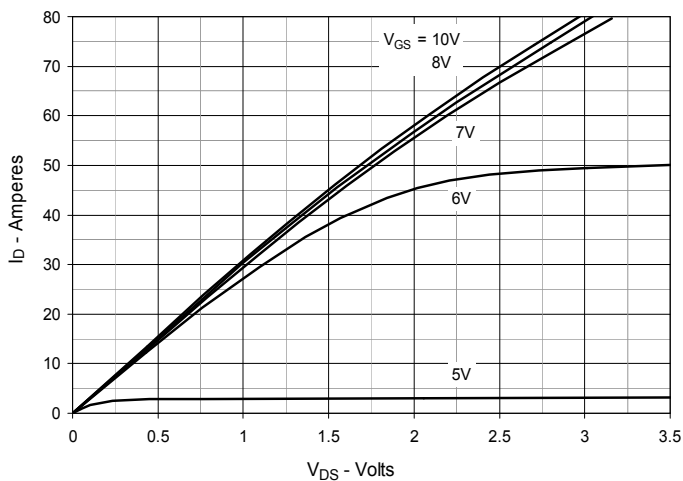

Fig. 2. Extended Output Characteristics @ $T_J = 25^\circ\text{C}$

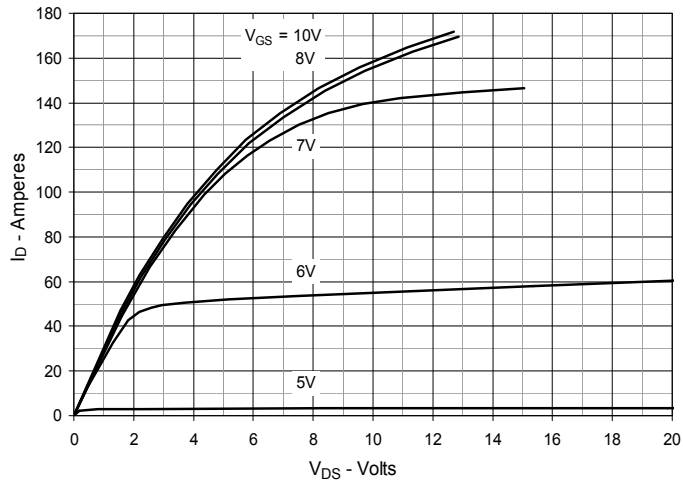

Fig. 3. Output Characteristics @ $T_J = 125^\circ\text{C}$

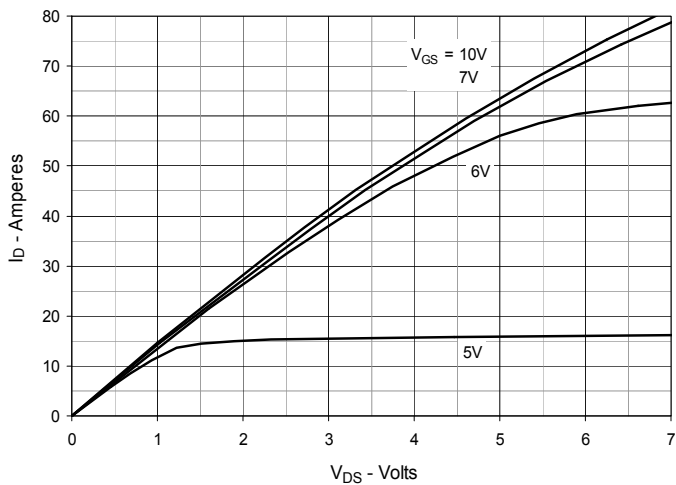

Fig. 4. $R_{DS(on)}$ Normalized to $I_D = 38\text{A}$ Value vs. Junction Temperature

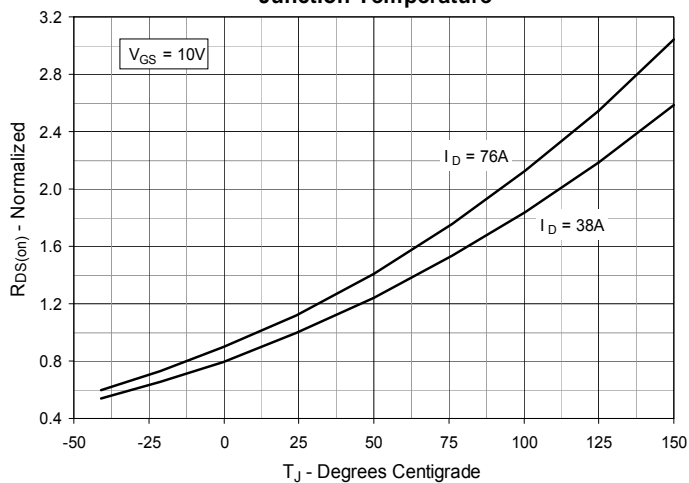

Fig. 5. $R_{DS(on)}$ Normalized to $I_D = 38\text{A}$ Value vs. Drain Current

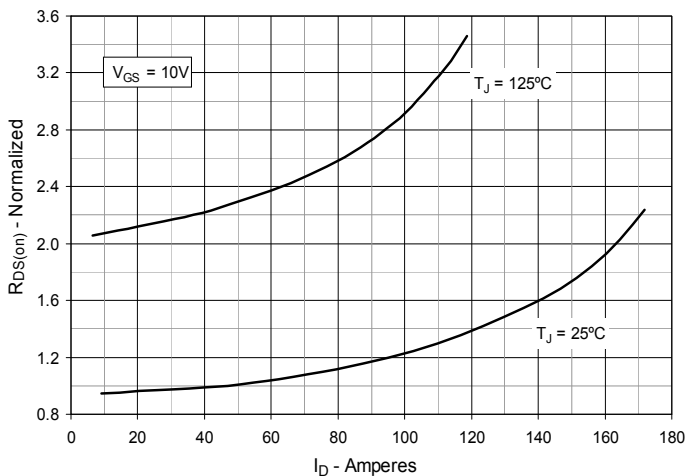

Fig. 6. Drain Current vs. Case Temperature

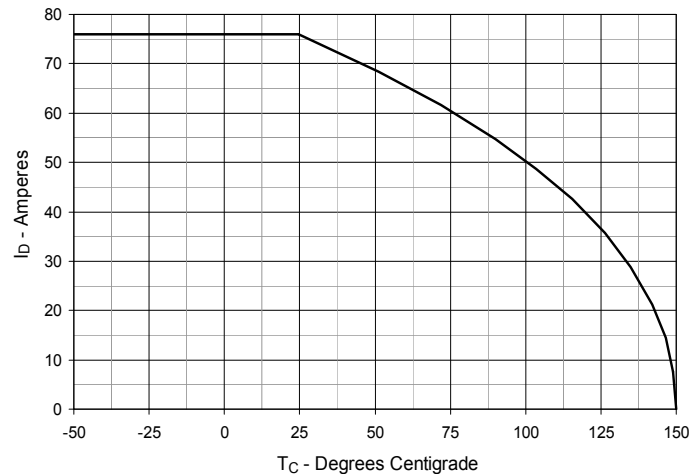

Fig. 7. Input Admittance

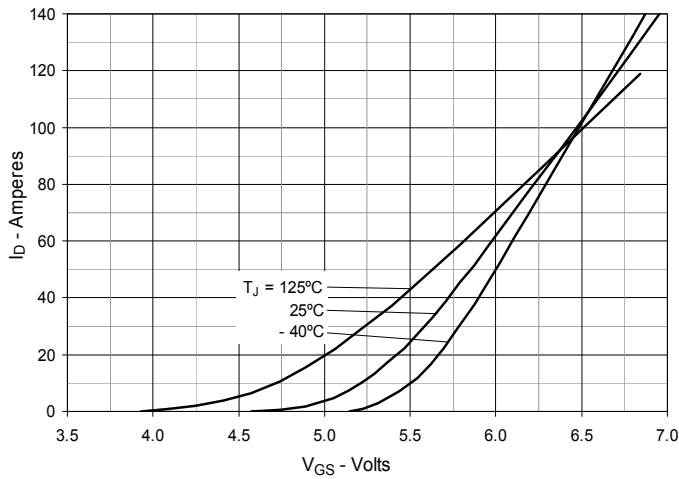

Fig. 8. Transconductance

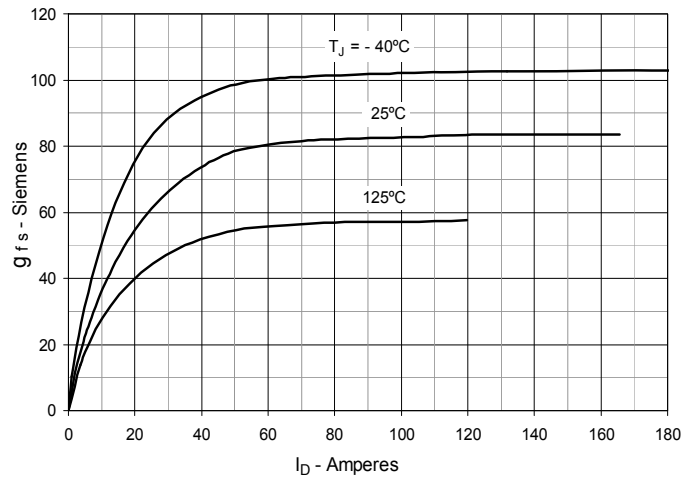

Fig. 9. Forward Voltage Drop of Intrinsic Diode

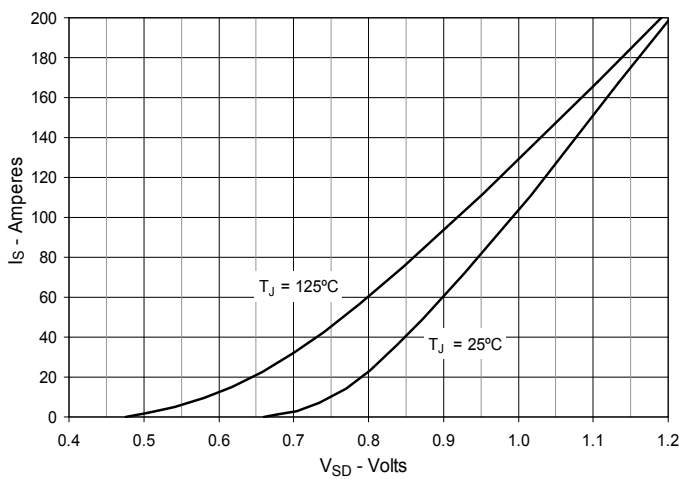

Fig. 10. Gate Charge

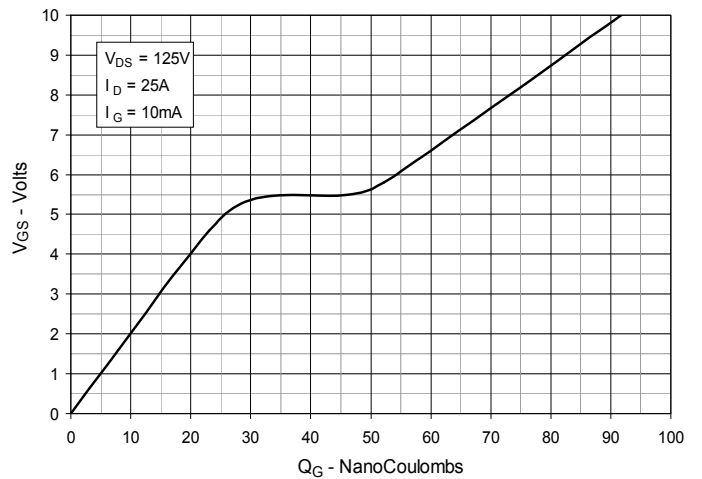

Fig. 11. Capacitance

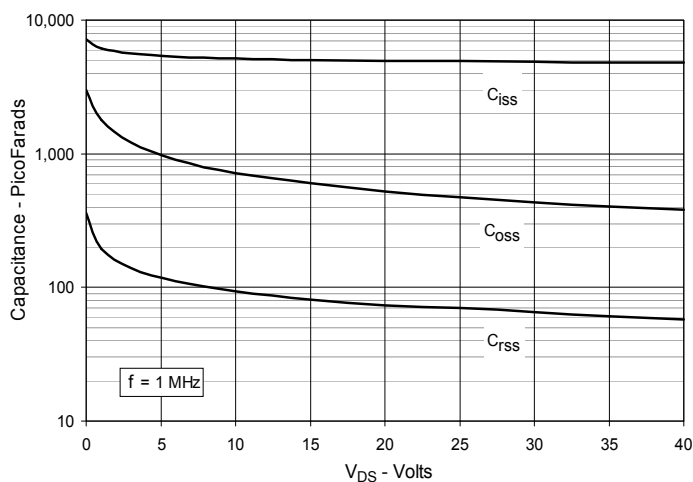

Fig. 12. Forward-Bias Safe Operating Area

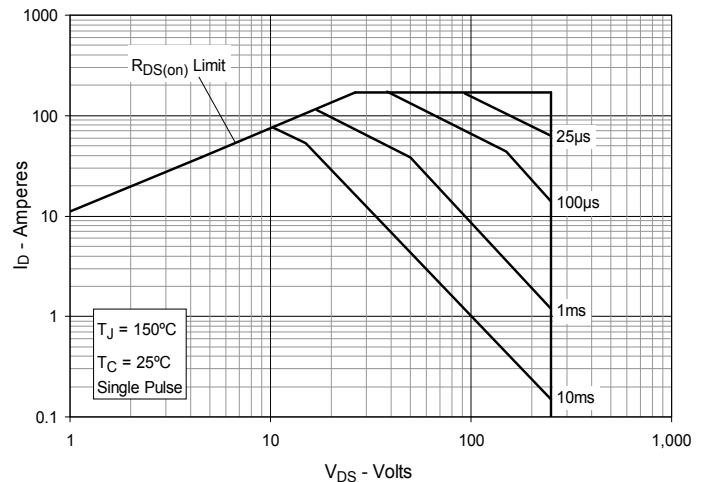

Fig. 13. Resistive Turn-on Rise Time vs. Junction Temperature

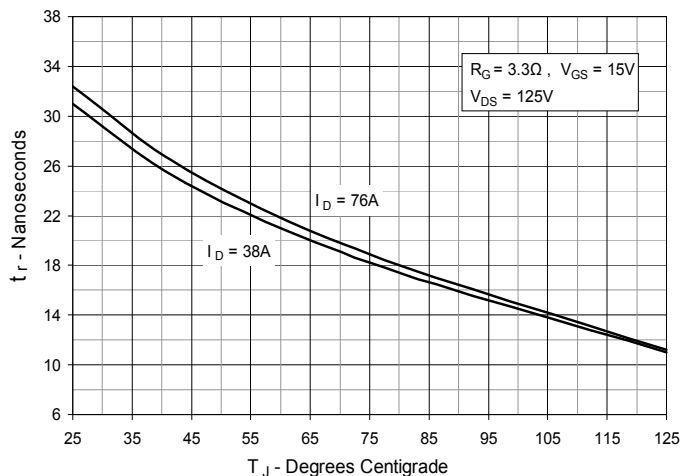

Fig. 14. Resistive Turn-on Rise Time vs. Drain Current

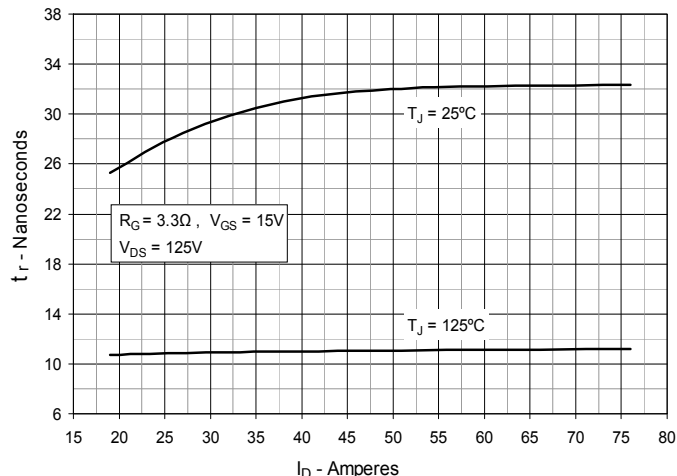

Fig. 15. Resistive Turn-on Switching Times vs. Gate Resistance

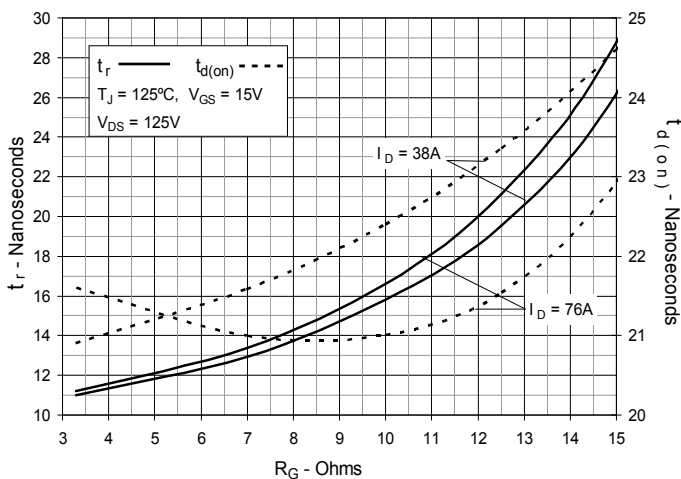

Fig. 16. Resistive Turn-off Switching Times vs. Junction Temperature

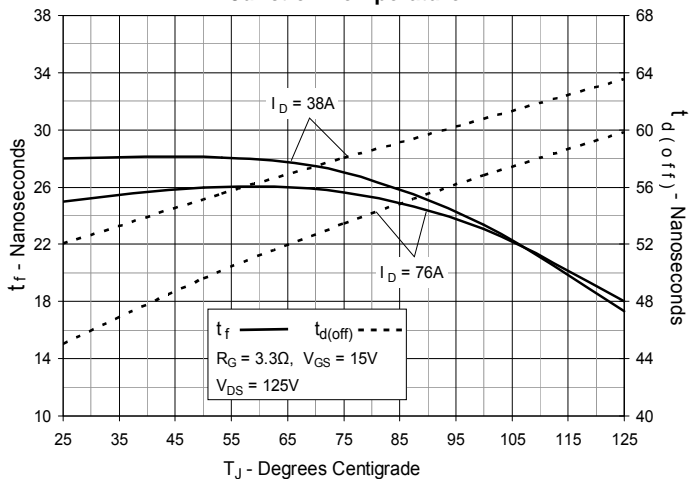

Fig. 17. Resistive Turn-off Switching Times vs. Drain Current

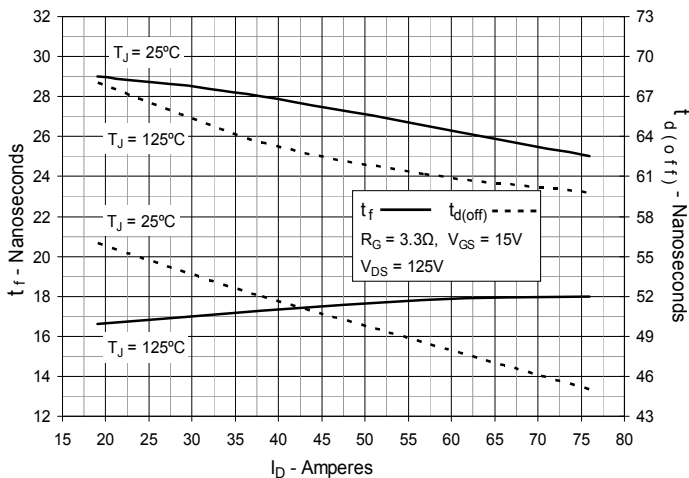

Fig. 18. Resistive Turn-off Switching Times vs. Gate Resistance

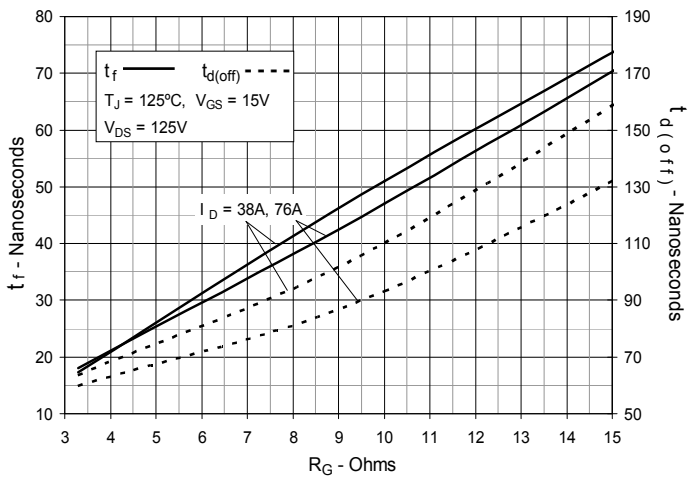

Fig. 19. Maximum Transient Thermal Impedance

