





Spec. No.	F-MICROMINIATURE-01-013
Issue Date	2018/9/7

NO.	MODEL NAME	CUSTOMER'S NO.
1	F101-N04B50K	
2		
3		
4		
5		

Marketing Dept.	Production Dept.	Quality Dept.	Engineering Dept.	Customer's Approval		
						

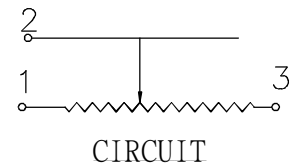
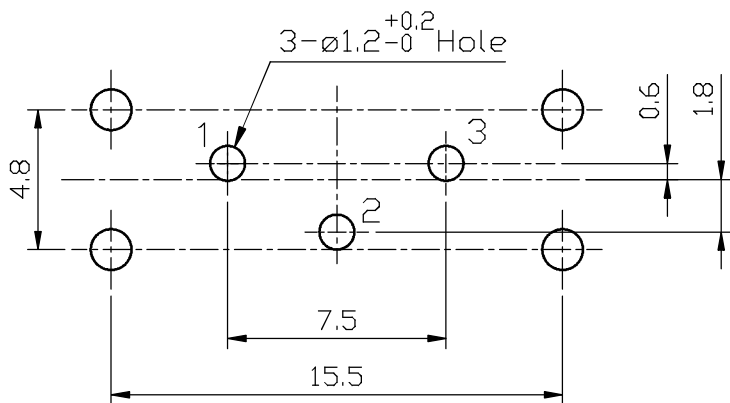
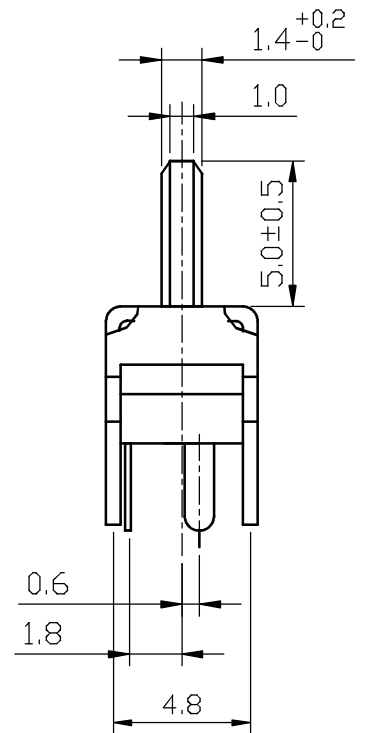
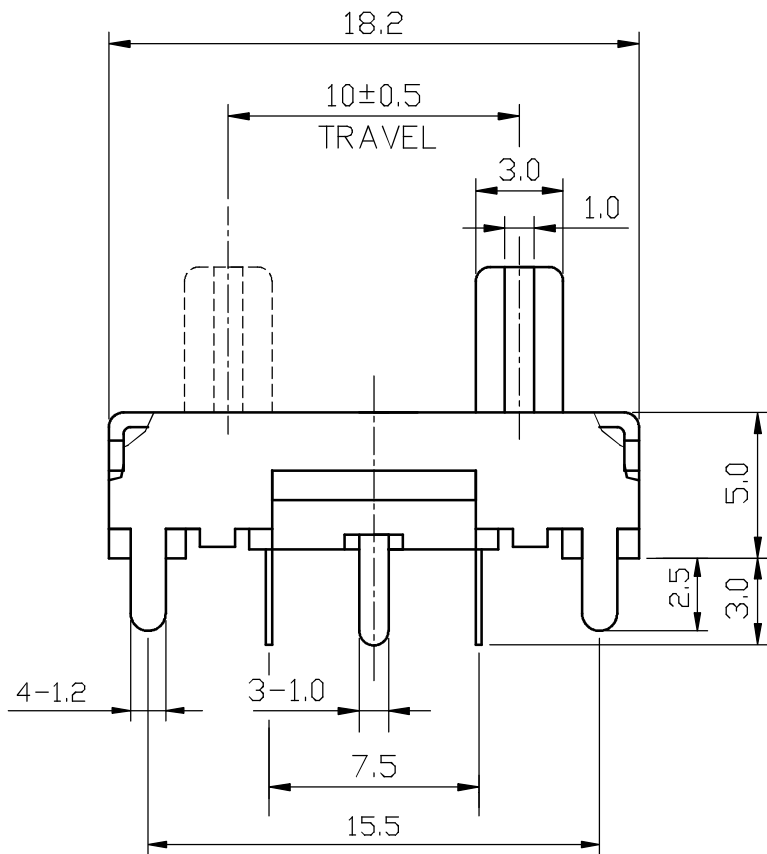

未指定容許±尺寸之公差	
10以下	±0.3
10~100	±0.5
100以上	±0.8
角 度	±5°

MTL		SPEC		DISPOSAL			
▲				UNIT	SCALE	TITLE	
▲				MM	4 / 1	MICROMIN Series	
▲				DRAWN	DESIGN	CHECK	APPROVAL
▲				劉小汀	劉小汀		鍾振華
▲				DATE	DESIGN	DWG NAME	
				2012.03.27		F101-N04	
DEVISION		DATE		DESIGN		DWG NO.	

一. ELECTRICAL CHARACTERISTICS 電氣特性

日期 (DATE): 2018/09/07

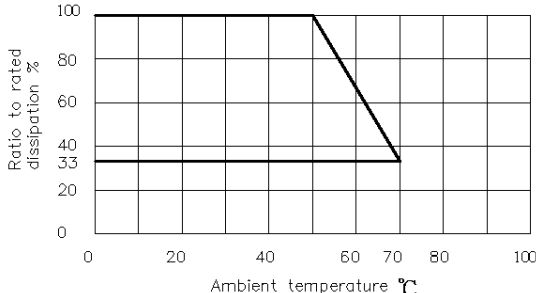
序號 NO.	項目 ITEM	性能 PERFORMANCE	測試條件 TEST CONDITIONS
1.1	Total resistance 全阻值	50KΩ±20%	Between terminal 1 and terminal 3. 1-3 端子間.
1.2	Resistance taper 阻抗特性型式	Type B Refer to attached drawing “Resistance taper characteristics”. B 型 見所附“阻型特性圖”.	It should be tested at the position of 50% of the effective use angle. Percentage of the voltage of (C、E、RD type terminal 2-3 and other type terminal 1-2 )to the voltage of terminal 1-3. 在有效使用角度的 50%的位置測定, (C、E、RD 阻型其端子 2-3 腳, 其它 阻型其端子 1-2 腳)電壓對端子 1-3 腳電 壓的百分比。
1.3	Rated power 額定功率	Single unit: <input checked="" type="checkbox"/> Linear taper B:0.03W <input type="checkbox"/> Other tapers : 0.015W Dual unit: <input type="checkbox"/> Linear taper B:0.015W <input type="checkbox"/> Other taper :0. 01W 單聯: <input checked="" type="checkbox"/> B 型: 0.03W <input type="checkbox"/> 其它阻型: 0.015W 雙聯: <input type="checkbox"/> B 型: 0.015W <input type="checkbox"/> 其它阻型: 0.01W	The rated power should be changed according to the following chart when the ambient temperature changed. 它與環境溫度按以下曲線變化。 DERATING CURVE OF RATED DISSIPATION 

1.4	Rated voltage 額定電壓	<input checked="" type="checkbox"/> Linear taper B: AC 100V <input type="checkbox"/> Other tapers : AC 50V <input checked="" type="checkbox"/> B 型 : AC 100V <input type="checkbox"/> 其它阻型 : AC 50V	$E = \sqrt{PR}$ E:額定電壓 Rated voltage(V) P:額定功率 Rated power(W) R:公稱阻值 Normal total resistance( $\Omega$ ) The rated voltage is calculated by above formula. When the rated voltage exceeds the maximum operating voltage, the maximum operating voltage should be the rated voltage. 額定電壓按以上公式計算, 當額定電壓超過最大工作電壓時, 最大工作電壓即為額定電壓.
1.5	Sliding noise 雜訊	Less than 100 mV 小於 100mV	By JIS method
1.6	Insulation resistance 絕緣阻抗	More than 50M $\Omega$ 50M $\Omega$ 以上.	Apply DC 100V to the specified terminal and other terminals. 指定端子與其它端子間加 DC 100V 電壓.
1.7	Withstand voltage 耐電壓特性	Without arcing or breakdown 無損壞或弧光	Apply AC 100V between specified terminal and other terminals for 1 minute. 指定端子與其它端子間加 AC 100V 電壓 1 分鐘.
1.8	Residual Resistance 殘留電阻值	Term1-2: Less than 10 $\Omega$ Term2-3: Less than 20 $\Omega$ 1-2 端子間 : 小於 10 $\Omega$ 2-3 端子間 : 小於 20 $\Omega$	Resistance between terminal 1-2 and terminal 2-3 in full CW sliding and full CCW sliding. 滑動座以逆時針方向和順時針方向滑動底時 1-2 與 2-3 腳之阻值.

## 二.MECHANICAL CHARACTERISTICS 機械特性

序號 NO	項目 ITEM	性能 PERFORMANCE	測試條件 TEST CONDITIONS
2.1	Total Sliding Travel 行程	10 mm $\pm$ 0.5 mm	
2.2	Operating Force 滑動力	10~100 gf	Traveling speed: 20mm/sec 每秒 20mm 滑動速度測定
2.3	Sliding Stopper Strength 止動強度	There should be no visual damage when minimum 2.5 Kgf.cm of torque are applied. 當其承受最小 2.5Kgf.cm 之推拉力時, 無明顯破壞及損傷.	Test duration: slide to terminal 1 and terminal 3 specifically for 5 $\pm$ 1 sec. 測試時間: 滑動至 1 腳端和 3 腳端各 5 $\pm$ 1 秒.
2.4	Push-Pull Strength of handle 滑柄推拉承受強度	There should be no broken when Maximally 1.0 Kgf of push strength and 1.0 Kgf pull strength are applied. 應用 1Kgf 的推力及 1Kgf 的拉力, 無損傷.	Test duration: 5 sec. of push force immediately followed by 10 sec. of pull force should be applied. Test point and direction: The strength should be applied to the top end of the handle in axial direction. 測試時間: 應用推力 5 秒鐘后立即應用拉力為 10 秒鐘; 測試點及方向: 測試點為滑柄頂部, 方向為軸向。

2.5	Handle Wobble 滑柄晃動	2(2×L)/25mm Max. L—Handle length L—滑柄長度	Apply 0.5kgf force perpendicular to the handle at the position of 2mm to the top of the handle. 在距滑柄頂端 2mm 處加 0.5kgf 且與滑柄垂直方向的力。
2.6	Number of detents (click) 段位數目	<input type="checkbox"/> 1C(Center Detent 中段功能) <input type="checkbox"/> 11C , <input type="checkbox"/> 21C , <input type="checkbox"/> 41C	For with-detent type. 加中段功能機種使用
2.7	Click force 段位推動力	<u>    </u> / ~ <u>    </u> gf	For with-detent type. 加中段功能機種使用

### 三. ENDURANCE CHARACTERISTICS 耐久性能

序號 NO	項目 ITEM	性能 PERFORMANCE	測試條件 TEST CONDITIONS
3.1	Dry heat 耐熱性	Variation of total resistance should be within $\begin{matrix} +5\% \\ -30\% \end{matrix}$ . To be operated mechanically. 全阻值變化要在 $\begin{matrix} +5\% \\ -30\% \end{matrix}$ 以內， 機械方面能動作。	Test temperature:80±2°C Test duration:240±8h Exposure under room temperature: 1h to 2h. 測試溫度 80±2°C， 時間 240±8 小時， 室溫保持 1 至 2 小時。
3.2	Cold 耐寒性	The total resistance change should be within ±20%. To be operated mechanically. 全阻值變化要在±20%以內， 機械方面能動作。	Test temperature:-30±3°C Load condition: No load Low temperature exposure:96±4h Exposure to room temperature:1h to 2h 測試溫度-30±3°C，無負載， 時間 96±4 小時，室溫保持 1 至 2 小時。
3.3	Damp heat 耐濕性	Insulation resistance: more than 10M Ω with 250V insulation resistance tester. The total resistance change should be within 20%. To be operated mechanically. 用 100V 絕緣測試機測試，絕緣阻抗 50MΩ 以上。全阻值變化要在±20%以內， 機械方面能動作。	Place the tested samples in the thermostat with the temperature 40±2°C and 90% to 95% of the relative humidity for 96 ±4 hrs, then drop off water and proceed test. 測試溫度 40±2°C，濕度 90%至 95%， 時間 96±4 小時，並在恆溫箱外擦干水珠后立即測試。

3.4	Temperature characteristic 溫度特性	<p>Variation rate of resistance unit: % 阻值變化率單位:%</p> <table border="1" data-bbox="470 206 914 526"> <thead> <tr> <th rowspan="2">Nominal total resistance(R)</th> <th colspan="2">Resistance law</th> </tr> <tr> <th>B</th> <th>Other tapers</th> </tr> </thead> <tbody> <tr> <td><math>R \leq 10K\Omega</math></td> <td>within +5 -20</td> <td>within +5 -20</td> </tr> <tr> <td><math>R &gt; 10K\Omega</math></td> <td>within +5 -25</td> <td>within +5 -30</td> </tr> </tbody> </table>	Nominal total resistance(R)	Resistance law		B	Other tapers	$R \leq 10K\Omega$	within +5 -20	within +5 -20	$R > 10K\Omega$	within +5 -25	within +5 -30	<p>Test temperature: <math>70 \pm 3^\circ\text{C}</math> Test duration: 5h 測試溫度 <math>70 \pm 3^\circ\text{C}</math>，時間 5 小時。</p>
Nominal total resistance(R)	Resistance law													
	B	Other tapers												
$R \leq 10K\Omega$	within +5 -20	within +5 -20												
$R > 10K\Omega$	within +5 -25	within +5 -30												
3.5	Vibration 振動	<p>To be operated mechanically. No sliding abnormality. Electrical characteristics are as usual. 機械方面能動作，滑動無異常，電氣性能正常。</p>	<p>Place the handle to the half-way of full sliding travel. Parts should be secured to a 10Hz and 55Hz logarithmic vibration machine by a mounting device. The test should be made with the vibration direction of X,Y, Z 3 directions perpendicular to the actuator and 2 hours for each direction. Leave the test sample in the room temp for 1-2 hrs. 把滑動座停留在全行程中間位置,然後把電位器放在頻率為 10Hz 與 55Hz 的正弦振動器上來回振動,在 X,Y,Z 三個方向,每一個方向振動 2 小時,然後在室溫放置 1 至 2 小時。</p>											
3.6	Salt mist 鹽霧試驗	<p>No apparent rust and discoloration 無明顯銹跡,無變色。</p>	<p>Test should be made with temperature of <math>35 \pm 2^\circ\text{C}</math> and concentration of <math>5 \pm 1\%</math> (by weight) for 16 h. Then clean with water. 在溫度為 <math>35 \pm 2^\circ\text{C}</math>,濃度(重量比)為 <math>5 \pm 1\%</math> 的條件下,進行 16 小時連續噴霧后取出水洗。</p>											
3.7	Solder ability 焊錫性	<p>Not less than 3/4 of the surface dipped shall be covered with new solder. 浸錫部分表面最少 3/4 被新錫覆蓋。</p>	<p>Temperature of solder: <math>235 \pm 5^\circ\text{C}</math> duration: <math>3 \pm 0.5\text{s}</math>. 焊錫溫度 <math>235 \pm 5^\circ\text{C}</math>，浸錫時間 <math>3 \pm 0.5</math> 秒。</p>											
3.8	Resistance to soldering heat 焊錫耐熱性	<p>Variation of total resistance shall be within <math>\pm 5\%</math>, and terminals shall not work loose to injure electric contact, after test. 全阻值變化<math>\pm 5\%</math>以內,測試後無端子鬆動,不會損壞電氣接點。</p>	<p>Solder dip: 浸焊 Preheating condition: Surface temperature of the substrate shall be settled within <math>100^\circ\text{C}</math> in one min. 預熱: 基板表面溫度 <math>100^\circ\text{C}</math> 以下, 1 分鐘內。 Solder temperature <math>260 \pm 5^\circ\text{C}</math> for 5 sec. 焊錫溫度 <math>260 \pm 5^\circ\text{C}</math>，5 秒。 Manual Soldering: Less than <math>350^\circ\text{C}</math> and quicker than 3 seconds. 手銲: <math>350^\circ\text{C}</math> 以下, 3 秒以內</p>											

3.9	Sliding life 滑動壽命	Variation of total resistance should be within $\pm 15\%$ , Sliding noise should be within 150 mV. 全阻值變化 $\pm 15\%$ 以內，滑動雜訊 150mV 以內。	15,000 cycles Min. 15,000 次以上.
-----	----------------------	--	-----------------------------------

#### 四.General 一般事項

序號 NO	項 目 ITEM	
4.1	Unless otherwise specified, test and measurement should be carried out in following condition: 如無特殊要求,試驗與測試將按以下條件進行：	
	Ambient temperature 溫度	15°C to 35°C
	Relative humidity 相對濕度	25% to 75%
	Air pressure 氣壓	86 KPa to 106 KPa
4.2	Operating temperature range 使用溫度範圍	-10°C to +70°C
4.3	Storage temperature range 儲存溫度範圍	-30°C to +80°C
核 準 Approved	審 查 Q.I.Department	經 辦 者 Design Dept
鍾振華		甘文峰

# SPECIFICATIONS

## Electrical characteristics

### • Resistance Taper Characteristics

Resistance Taper Characteristic	Test Position (%)	$\frac{V1-2}{V1-3} \times 100\%$ (%)	$\frac{V2-3}{V1-3} \times 100\%$ (%)
<b>A</b>	50	10~25	—
<b>B</b>	50	40~60	—
<b>C</b>	50 (started from Term.3)	—	10~25
<b>D</b>	50	6~15	—
<b>E</b>	50	—	18~34
<b>W</b>	30 (±5 degree)	5~15	—
	50	40~60	—
	70 (±5 degree)	85~95	—

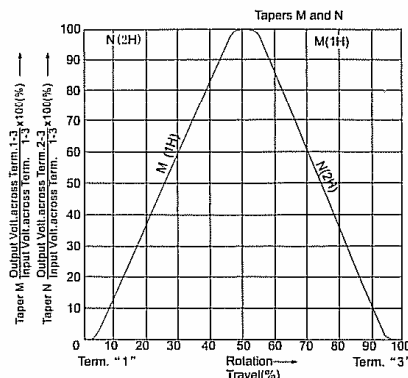
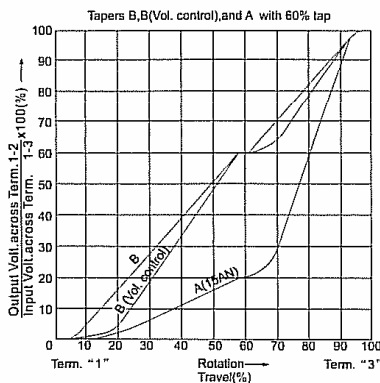
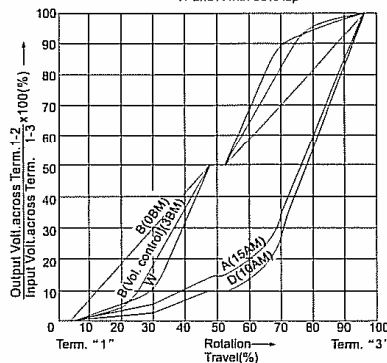
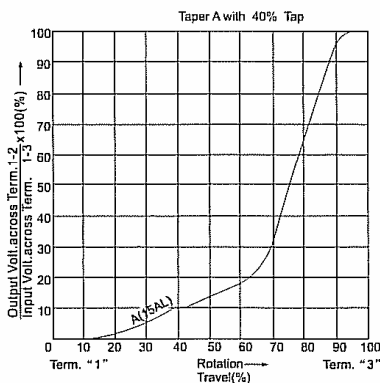
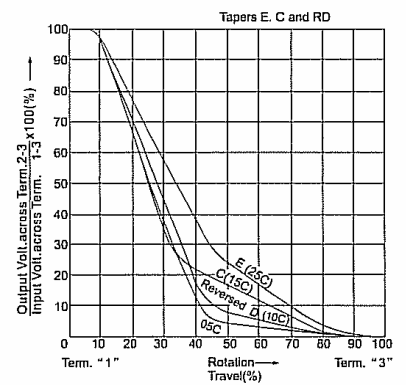
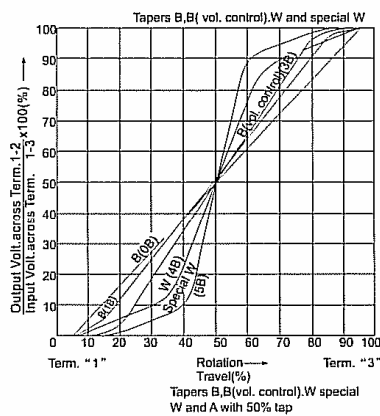
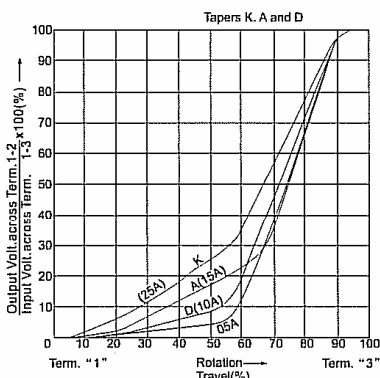

NOTE: Resistance characteristic of curve N is plotted With respect to terminal "3"