

Features

1. Current transfer ratio
(CTR : MIN.50% at $I_F=5mA$ $V_{CE}=5V$)
2. High isolation voltage between input and output(Viso : 5000Vrms).
3. Compact dual-in-line package.

Applications

1. Registers, copiers, automatic vending machines.
2. System appliances, measuring instruments.
3. Computer terminals, programmable controllers.
4. Communications, telephone, etc.
5. Electric home appliances, such as oil fan heaters, Microwave oven, Washer, Refrigerator, Air conditioner, etc.
6. Medical instruments, physical and chemical equipment.
7. Signal transmission between circuits of different potentials and impedances.
8. Facsimile equipment, Audio, Video.
9. Switching power supply, Laser beam printer.

Outside Dimension:Unit (mm)

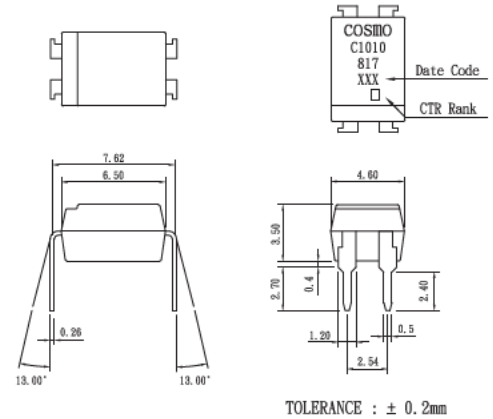

Schematic:Top View

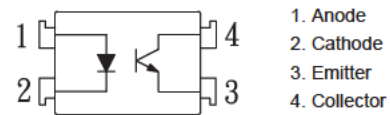

Absolute Maximum Ratings

(Ta=25°C)

Parameter		Symbol	Rating	Unit
Input	Forward current	I_F	50	mA
	Peak forward current	I_{FM}	1	A
	Reverse voltage	V_R	6	V
	Power dissipation	P_D	70	mW
Output	Collector-emitter voltage	V_{CEO}	70	V
	Emitter-collector voltage	V_{ECO}	6	V
	Collector current	I_C	50	mA
	Collector power dissipation	P_C	150	mW
Total power dissipation		P_{tot}	200	mW
Isolation voltage 1 minute		Viso	5000	Vrms
Operating temperature		T_{opr}	-30 to +115	C
Storage temperature		T_{stg}	-55 to +125	C
Soldering temperature 10 second		T_{sol}	260	C

Electro-optical Characteristics

(Ta=25°C)

Parameter		Symbol	Conditions	MIN.	TYP.	MAX.	Unit
Input	Forward voltage	V_F	$I_F=20mA$		1.2	1.4	V
	Peak forward voltage	V_{FM}	$I_{FM}=0.5A$	旣		3.0	V
	Reverse current	I_R	$V_R=4V$			10	uA
	Terminal capacitance	C_t	$V=0, f=1kHz$	旣	30		pF
Output	Collector dark current	I_{CEO}	$V_{CE}=20V$			0.1	uA
Transfer characteristics	Current transfer ratio	CTR	$I_F=5mA, V_{CE}=5V$	50		600	%
	Collector-emitter saturation voltage	$V_{CE(sat)}$	$I_F=20mA, I_C=1mA$		0.1	0.2	V
	Isolation resistance	Riso	DC500V	5×10^{10}	10^{11}		ohm
	Floating capacitance	C_f	$V=0, f=1MHz$		0.6	1.0	pF
	Cut-off frequency	f_c	$V_{CC}=5V, I_C=2mA, R_L=100ohm$		80		kHz
	Response time (Rise)	t_r	$V_{CE}=2V, I_C=2mA, R_L=100ohm$		4	18	us
Response time (Fall)	t_f			3	18	us	

Classification table of current transfer ratio is shown below.

Model NO.	CTR (%)
A Rank	80 TO 160
B Rank	130 TO 260
C Rank	200 TO 400
D Rank	300 TO 600
E Rank	50 TO 600

Fig.1 Current Transfer Ratio vs. Forward Current

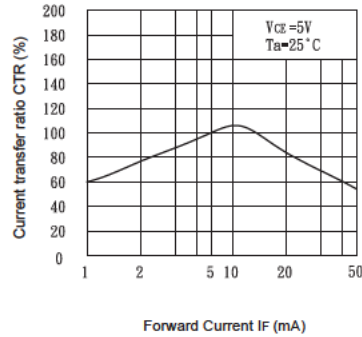

Fig.2 Collector Power Dissipation vs. Ambient Temperature

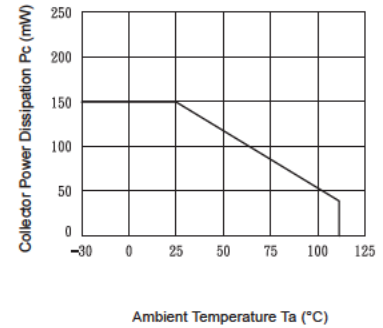

Fig.3 Collector Dark Current vs. Ambient Temperature

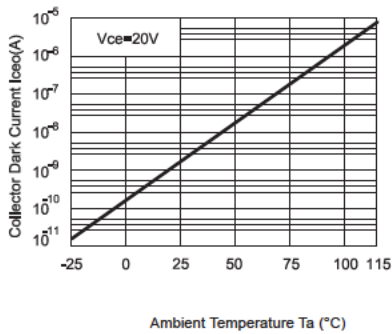

Fig.4 Forward Current vs. Ambient Temperature

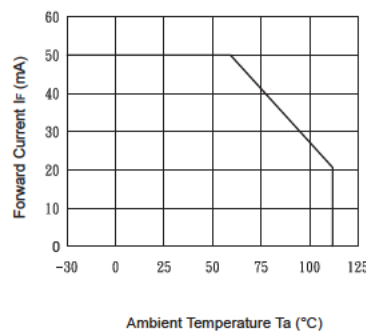

Fig.5 Forward Current vs. Forward Voltage

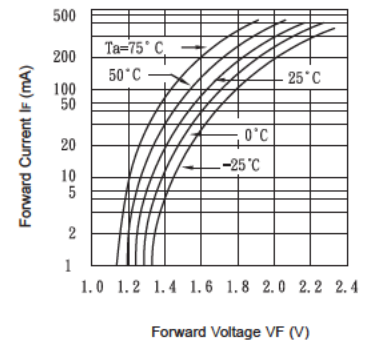

Fig.6 Collector Current vs. Collector-emitter Voltage

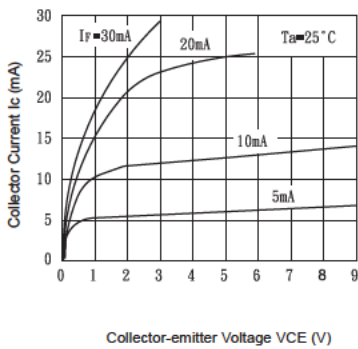

Fig.7 Relative Current Transfer Ratio vs. Ambient Temperature

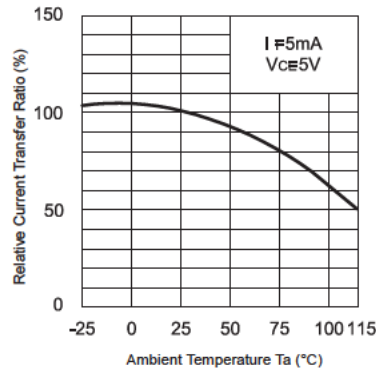

Fig.8 Collector-emitter Saturation Voltage vs. Ambient Temperature

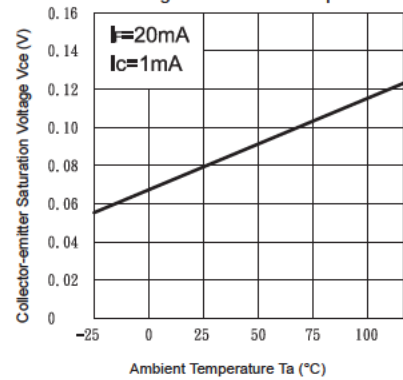

Fig.9 Collector-emitter Saturation Voltage vs. Forward Current

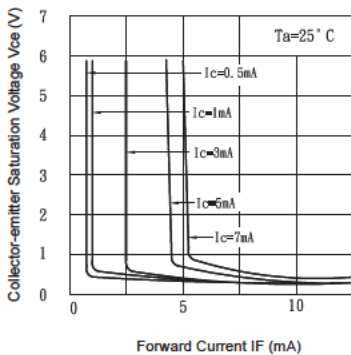

Fig.10 Collector Current vs. Ambient Temperature

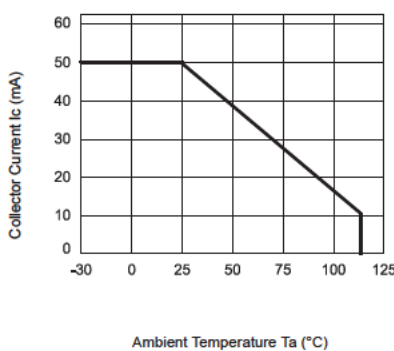

Fig.11 Input Power Dissipation vs. Ambient Temperature

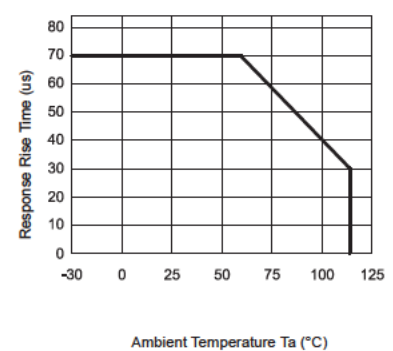

Fig.12 Response Time vs. Load Resistance

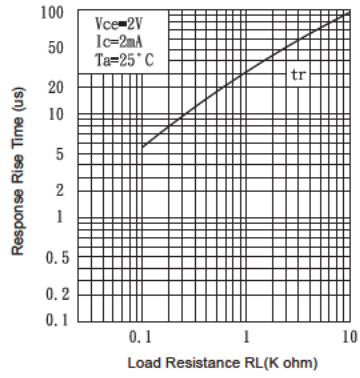

Fig.13 Response Time vs. Load Resistance

