

SEMITRANS® 3

Superfast NPT-IGBT Modules

SKM 200GB063D

Features

- N channel, homogeneous Silicon structure (NPT - Non punch-through IGBT)
- Low tail current with low temperature dependence
- High short circuit capability, self limiting if term. G is clamped to E
- Pos. temp.-coeff. of V_{CEsat}
- 50 % less turn off losses
- 30 % less short circuit current
- Very low C_{ies} , C_{oes} , C_{res}
- Latch-up free
- Fast & soft inverse CAL diodes
- Isolated copper baseplate using DCB Direct Copper Bonding Technology without hard mould
- Large clearance (13 mm) and creepage distances (20 mm)

Typical Applications*

- Switched mode power supplies
- AC inverter servo drives
- UPS uninterruptible power supplies
- Welding inverters

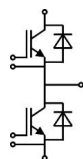

GB

Absolute Maximum Ratings		$T_c = 25\text{ }^\circ\text{C}$, unless otherwise specified		
Symbol	Conditions	Values		Units
IGBT				
V_{CES}	$T_j = 25\text{ }^\circ\text{C}$	600		V
I_C	$T_j = 150\text{ }^\circ\text{C}$	$T_{case} = 25\text{ }^\circ\text{C}$	260	A
		$T_{case} = 70\text{ }^\circ\text{C}$	200	A
I_{CRM}	$I_{CRM} = 2 \times I_{Cnom}$	400		A
V_{GES}		± 20		V
t_{psc}	$V_{CC} = 300\text{ V}$; $V_{GE} \leq 20\text{ V}$; $T_j = 125\text{ }^\circ\text{C}$ $V_{CES} < 600\text{ V}$	10		μs
Inverse Diode				
I_F	$T_j = 150\text{ }^\circ\text{C}$	$T_{case} = 25\text{ }^\circ\text{C}$	200	A
		$T_{case} = 80\text{ }^\circ\text{C}$	135	A
I_{FRM}	$I_{FRM} = 2 \times I_{Fnom}$	400		A
I_{FSM}	$t_p = 10\text{ ms}$; sin.	$T_j = 150\text{ }^\circ\text{C}$	1400	A
Module				
$I_{t(RMS)}$		500		A
T_{vj}		- 40 ... + 150		$^\circ\text{C}$
T_{stg}		- 40 ... + 125		$^\circ\text{C}$
V_{isol}	AC, 1 min.	2500		V

Characteristics		$T_c = 25\text{ }^\circ\text{C}$, unless otherwise specified			
Symbol	Conditions	min.	typ.	max.	Units
IGBT					
$V_{GE(th)}$	$V_{GE} = V_{CE}$, $I_C = 4\text{ mA}$	4,5	5,5	6,5	V
I_{CES}	$V_{GE} = 0\text{ V}$, $V_{CE} = V_{CES}$		0,1	0,3	mA
V_{CE0}		$T_j = 25\text{ }^\circ\text{C}$	1,05		V
		$T_j = 125\text{ }^\circ\text{C}$	1		V
r_{CE}	$V_{GE} = 15\text{ V}$	$T_j = 25\text{ }^\circ\text{C}$	5,3		$\text{m}\Omega$
		$T_j = 125\text{ }^\circ\text{C}$	7		$\text{m}\Omega$
$V_{CE(sat)}$	$I_{Cnom} = 200\text{ A}$, $V_{GE} = 15\text{ V}$	$T_j = 25\text{ }^\circ\text{C}_{chiplev.}$	2,1	2,5	V
		$T_j = 125\text{ }^\circ\text{C}_{chiplev.}$	2,4	2,8	V
C_{res}	$V_{CE} = 25$, $V_{GE} = 0\text{ V}$	$f = 1\text{ MHz}$	11,2		nF
C_{oes}			1,25		nF
C_{res}			0,75		nF
Q_G	$V_{GE} = 0\text{ V} - +15\text{ V}$		480		nC
R_{Gint}	$T_j = \text{ }^\circ\text{C}$		0		Ω
$t_{d(on)}$	$R_{Gon} = 8\text{ }\Omega$	$V_{CC} = 300\text{ V}$ $I_C = 200\text{ A}$	140		ns
t_r			70		ns
E_{on}			11		mJ
$t_{d(off)}$	$R_{Goff} = 8\text{ }\Omega$	$T_j = 125\text{ }^\circ\text{C}$ $V_{GE} = \pm 15\text{ V}$	442		ns
t_f			45		ns
E_{off}			7,5		mJ
$R_{th(j-c)}$	per IGBT			0,14	K/W

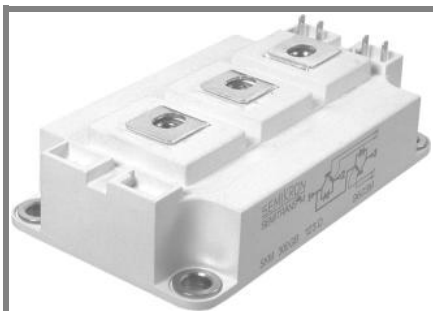

SEMITRANS® 3

Superfast NPT-IGBT Modules

SKM 200GB063D

Features

- N channel, homogeneous Silicon structure (NPT - Non punch-through IGBT)
- Low tail current with low temperature dependence
- High short circuit capability, self limiting if term. G is clamped to E
- Pos. temp.-coeff. of V_{CEsat}
- 50 % less turn off losses
- 30 % less short circuit current
- Very low C_{ies} , C_{oes} , C_{res}
- Latch-up free
- Fast & soft inverse CAL diodes
- Isolated copper baseplate using DCB Direct Copper Bonding Technology without hard mould
- Large clearance (13 mm) and creepage distances (20 mm)

Typical Applications*

- Switched mode power supplies
- AC inverter servo drives
- UPS uninterruptable power supplies
- Welding inverters

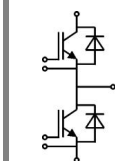

GB

Characteristics

Symbol	Conditions	min.	typ.	max.	Units
Inverse Diode					
$V_F = V_{EC}$	$I_{Fnom} = 200 \text{ A}; V_{GE} = 0 \text{ V}$		1,55	1,9	V
					$T_j = 25 \text{ }^\circ\text{C}_{chiplev.}$
			1,55		$T_j = 125 \text{ }^\circ\text{C}_{chiplev.}$
V_{F0}				0,9	V
					$T_j = 125 \text{ }^\circ\text{C}$
r_F			4	5,5	mΩ
					$T_j = 125 \text{ }^\circ\text{C}$
I_{RRM}	$I_F = 200 \text{ A}$		75		A
Q_{rr}			12,7		μC
E_{rr}	$V_{GE} = -15 \text{ V}; V_{CC} = 600 \text{ V}$				mJ
$R_{th(j-c)D}$	per diode			0,3	K/W
Module					
L_{CE}			15	20	nH
$R_{CC'+EE'}$	res., terminal-chip	$T_{case} = 25 \text{ }^\circ\text{C}$	0,35		mΩ
		$T_{case} = 125 \text{ }^\circ\text{C}$	0,5		mΩ
$R_{th(c-s)}$	per module			0,038	K/W
M_s	to heat sink M6		3	5	Nm
M_t	to terminals M6		2,5	5	Nm
w				325	g

This is an electrostatic discharge sensitive device (ESDS), international standard IEC 60747-1, Chapter IX.

* The specifications of our components may not be considered as an assurance of component characteristics. Components have to be tested for the respective application. Adjustments may be necessary. The use of SEMIKRON products in life support appliances and systems is subject to prior specification and written approval by SEMIKRON. We therefore strongly recommend prior consultation of our personal.

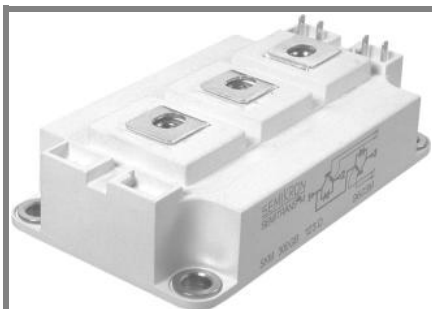

SEMITRANS® 3

Superfast NPT-IGBT Modules

SKM 200GB063D

Features

- N channel, homogeneous Silicon structure (NPT - Non punch-through IGBT)
- Low tail current with low temperature dependence
- High short circuit capability, self limiting if term. G is clamped to E
- Pos. temp.-coeff. of V_{CEsat}
- 50 % less turn off losses
- 30 % less short circuit current
- Very low C_{ies} , C_{oes} , C_{res}
- Latch-up free
- Fast & soft inverse CAL diodes
- Isolated copper baseplate using DCB Direct Copper Bonding Technology without hard mould
- Large clearance (13 mm) and creepage distances (20 mm)

Typical Applications*

- Switched mode power supplies
- AC inverter servo drives
- UPS uninterruptable power supplies
- Welding inverters

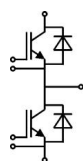

GB

Z_{th}		Conditions	Values	Units
$Z_{th(j-c)I}$				
$R_{\theta j-c}$		i = 1	90	mk/W
$R_{\theta j-c}$		i = 2	39	mk/W
$R_{\theta j-c}$		i = 3	9	mk/W
$R_{\theta j-c}$		i = 4	2	mk/W
$\tau_{th(j-c)}$		i = 1	0,0416	s
$\tau_{th(j-c)}$		i = 2	0,0139	s
$\tau_{th(j-c)}$		i = 3	0,0021	s
$\tau_{th(j-c)}$		i = 4	0,0001	s
$Z_{th(j-c)D}$				
$R_{\theta j-c}$		i = 1	200	mk/W
$R_{\theta j-c}$		i = 2	84	mk/W
$R_{\theta j-c}$		i = 3	14	mk/W
$R_{\theta j-c}$		i = 4	2	mk/W
$\tau_{th(j-c)}$		i = 1	0,0275	s
$\tau_{th(j-c)}$		i = 2	0,0413	s
$\tau_{th(j-c)}$		i = 3	0,0019	s
$\tau_{th(j-c)}$		i = 4	0,004	s

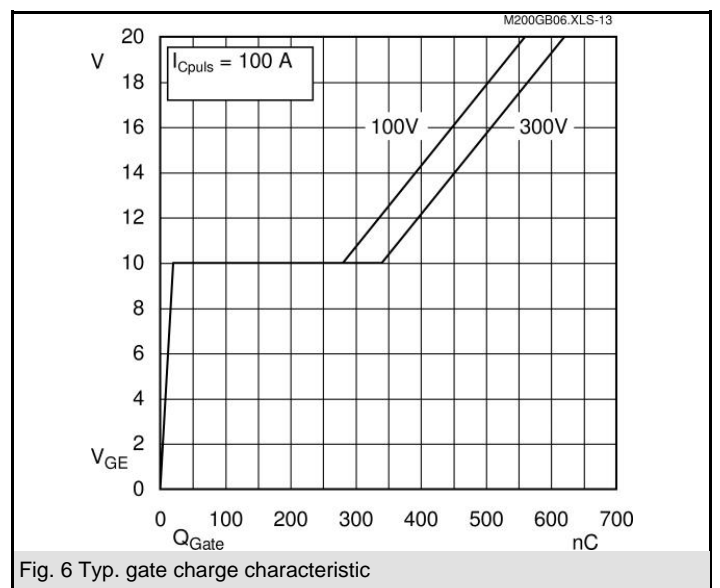
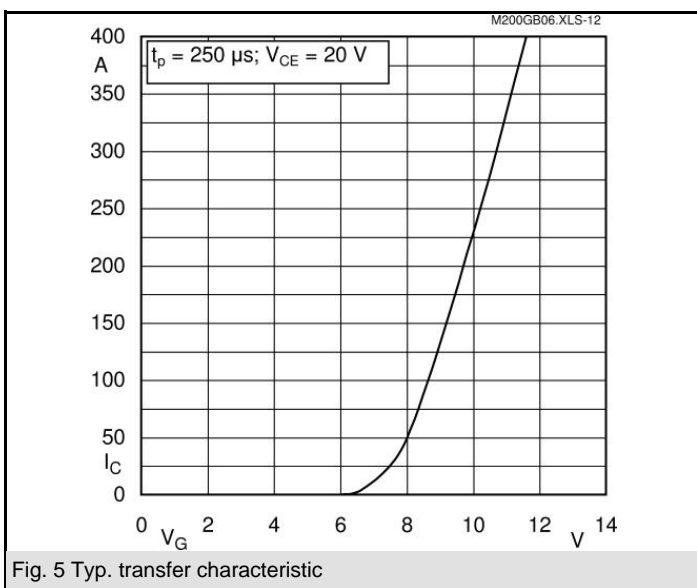
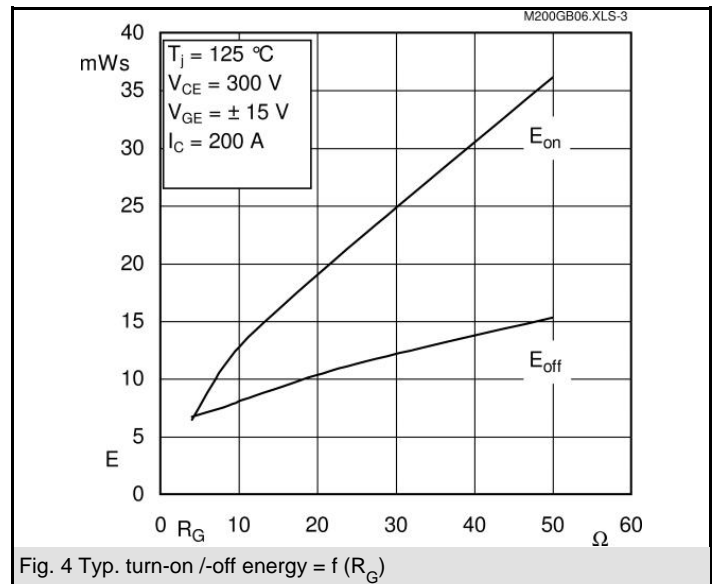
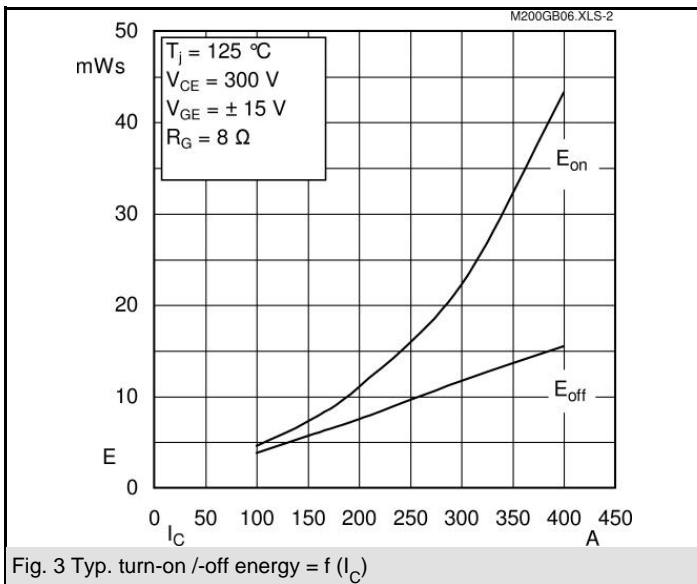
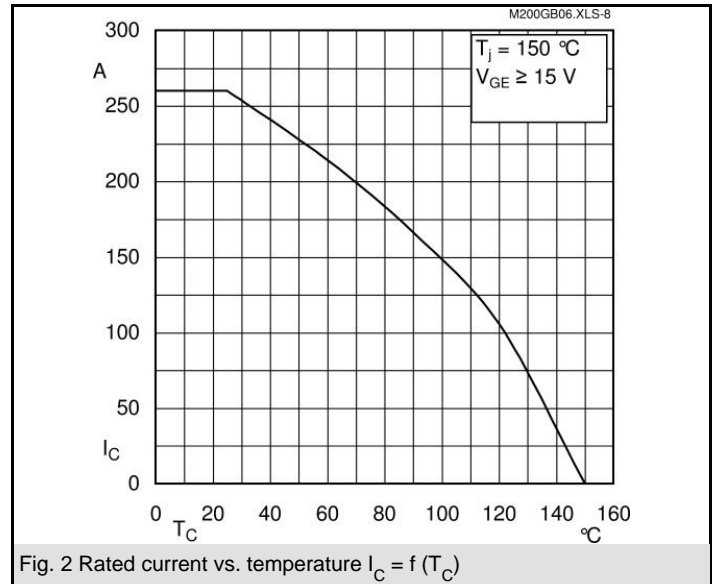
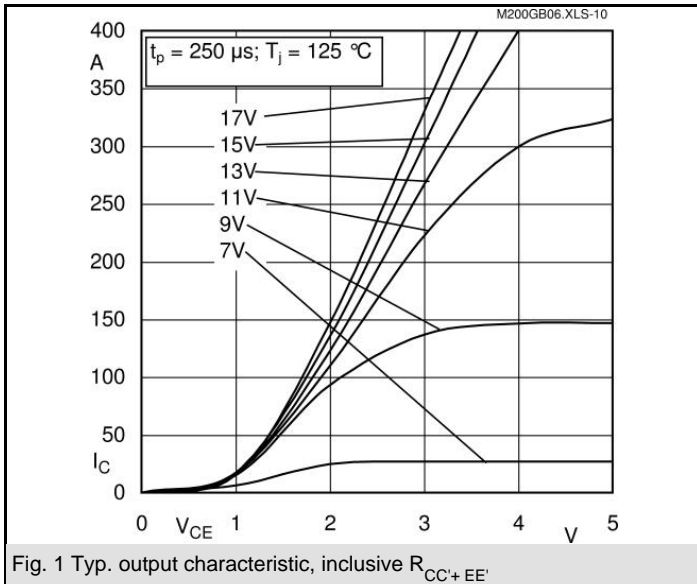

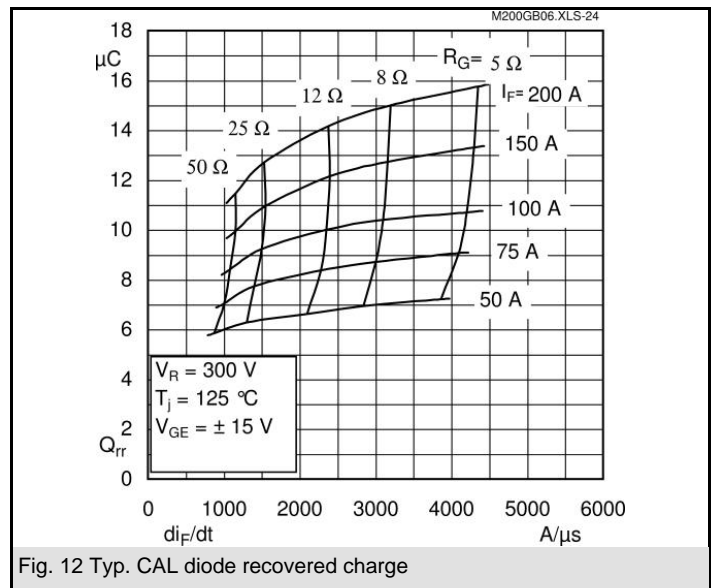
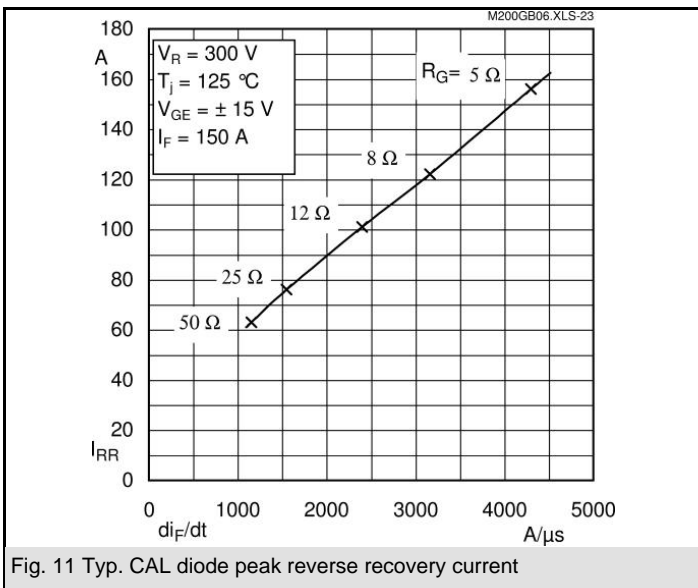
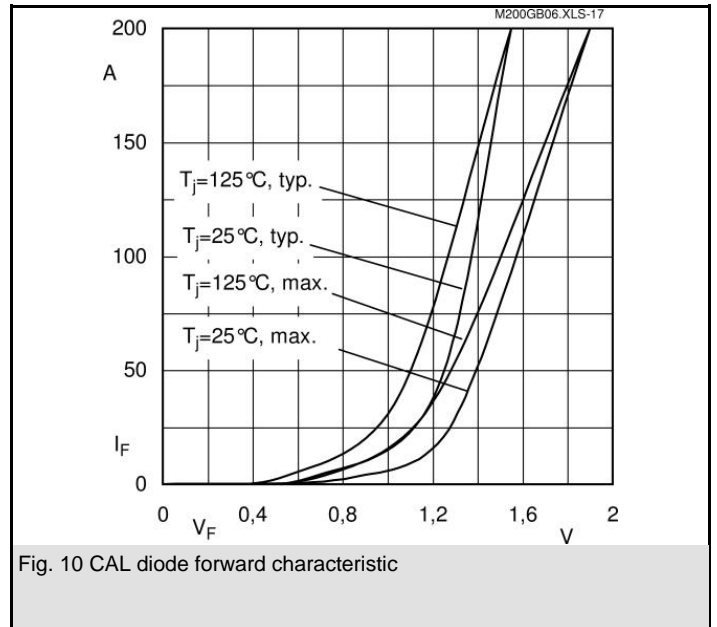
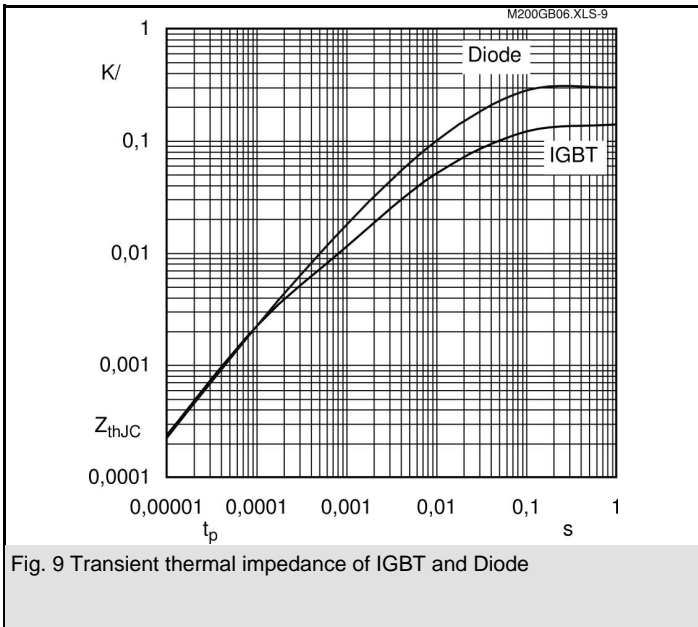
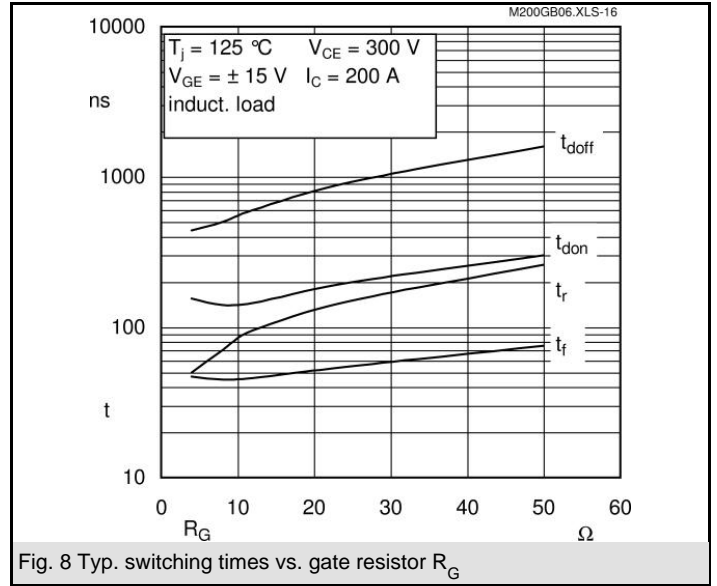
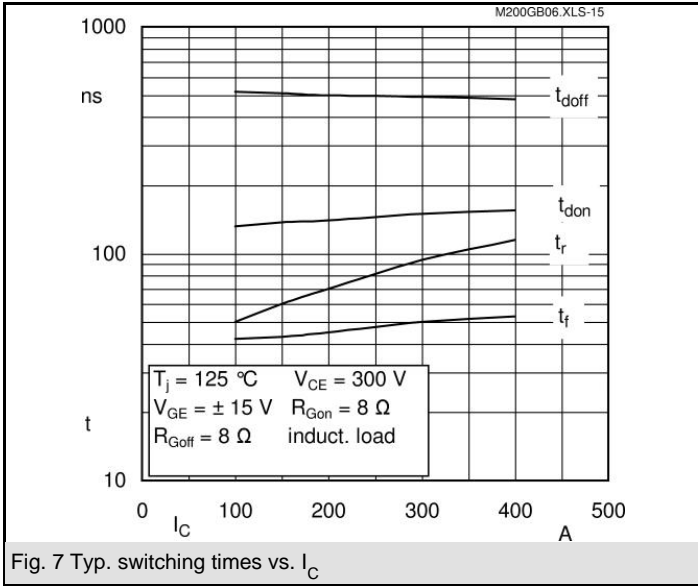

SKM 200GB063D

UL recognized

CASED56

File no. E 63 532

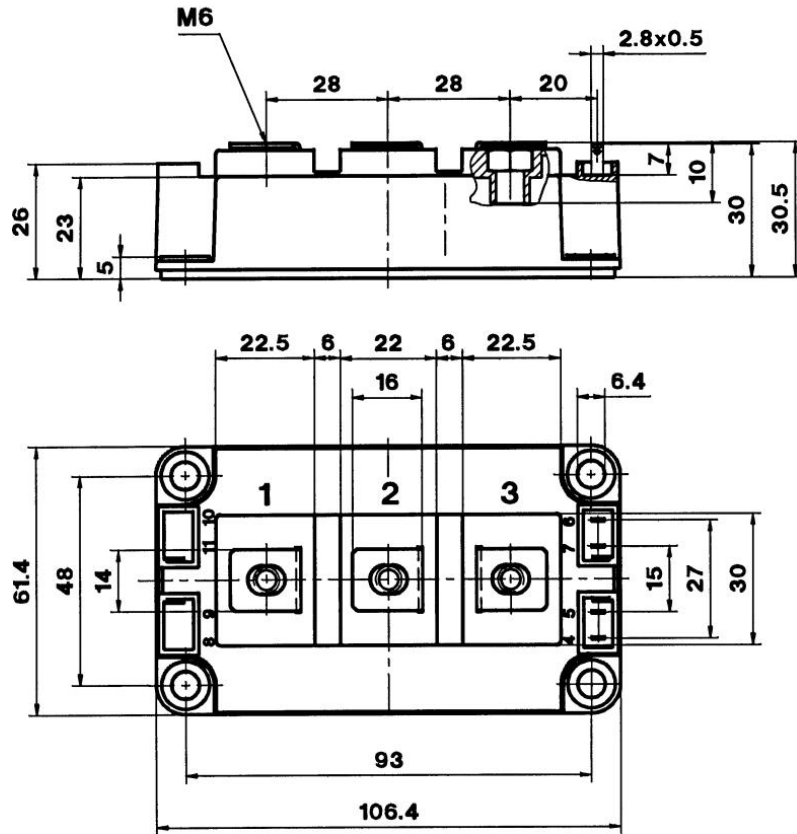

Case D 56

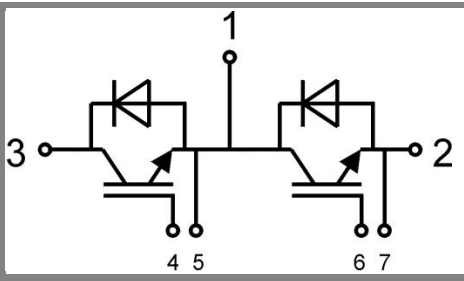

GB

Case D 56