

**NuMicro<sup>®</sup> Family**  
**Based on Arm<sup>®</sup> Cortex<sup>®</sup>-M23**

# **NuMaker-M2354**

## **User Manual**

***Evaluation Board for NuMicro<sup>®</sup> M2354 Series***

*The information described in this document is the exclusive intellectual property of Nuvoton Technology Corporation and shall not be reproduced without permission from Nuvoton.*

*Nuvoton is providing this document only for reference purposes of NuMicro microcontroller based system design. Nuvoton assumes no responsibility for errors or omissions.*

*All data and specifications are subject to change without notice.*

For additional information or questions, please contact: Nuvoton Technology Corporation.

[www.nuvoton.com](http://www.nuvoton.com)

**Table of Contents**

1 Overview ..... 7

2 Features ..... 8

3 Hardware Configuration ..... 9

    3.1 Front View..... 9

    3.2 Rear View .....10

    3.3 Extension Connectors.....11

        3.3.1 Pin Assignment for Extension Connectors..... 11

        3.3.2 Arduino UNO Compatible Extension Connectors ..... 17

    3.4 Power Supply Configuration .....19

        3.4.1 VIN Power Source ..... 19

        3.4.2 5V Power Sources..... 19

        3.4.3 3.3 V Power Sources..... 19

        3.4.4 1.8V Power Sources ..... 20

        3.4.5 Power Connectors ..... 20

        3.4.6 USB Connectors ..... 20

        3.4.7 Power Switches ..... 20

        3.4.8 Power Supply Models ..... 21

    3.5 External Reference Voltage Connector .....24

    3.6 Ammeter Connector .....24

    3.7 Push-Buttons .....24

    3.8 MicroSD Card Slot.....24

    3.9 SWD / ETM interface.....25

    3.10 LEDs .....25

    3.11 Wi-Fi Module (ESP-12) .....25

    3.12 HTN-LCD Panel.....26

    3.13 Nu-Link2-Me .....27

        3.13.1 VCOM Switches..... 27

        3.13.2 Status LEDs ..... 27

4 Quick Start ..... 28

    4.1 Toolchains Support.....28

    4.2 Nuvoton Nu-Link Driver Installation .....28

    4.3 BSP Firmware Download.....30

    4.4 Hardware Setup.....30

- 4.5 Finding the Example Project .....32
- 4.6 Executing the Project under Toolchains .....32
  - 4.6.1 Keil MDK ..... 32
  - 4.6.2 IAR EWARM..... 35
  - 4.6.3 NuEclipse ..... 37
- 5 NuMaker-M2354 Schematics ..... 43
  - 5.1 Nu-Link2-Me .....43
  - 5.2 M2354 target Board .....44
  - 5.3 USB 2.0 FS OTG .....45
  - 5.4 Power Supply.....46
  - 5.5 MCU Connector .....47
  - 5.6 Arduino UNO Compatible Interface .....48
  - 5.7 MicroSD Card .....49
  - 5.8 Wi-Fi Module (ESP-12) .....50
  - 5.9 LCD interface .....51
  - 5.10 PCB Placement .....52
- 6 REVISION HISTORY ..... 53

**List of Figures**

Figure 1-1 NuMaker-M2354 Board ..... 7

Figure 3-1 Front View of NuMaker-M2354..... 9

Figure 3-2 Rear View of NuMaker-M2354 ..... 10

Figure 3-3 M2354 Extension Connectors ..... 11

Figure 3-4 Arduino UNO Compatible Extension Connectors..... 17

Figure 3-5 External Power Supply Sources on Nu-Link2-Me ..... 21

Figure 3-6 External Power Supply Sources on M2354 target board ..... 22

Figure 3-7 Separate the Nu-Link2-Me from NuMaker-M2354 ..... 23

Figure 3-8 Wiring between Ammeter Connector and Ammeter..... 24

Figure 3-9 LCD interface ..... 26

Figure 4-1 Nu-Link USB Driver Installation Setup..... 28

Figure 4-2 Nu-Link USB Driver Installation ..... 29

Figure 4-3 Open VCOM Function ..... 30

Figure 4-4 ICE USB Connector..... 30

Figure 4-5 Device Manger..... 31

Figure 4-6 PuTTY Session Setting..... 31

Figure 4-7 Blinky Project Folder Path ..... 32

Figure 4-8 Debugger Setting in Options Window..... 32

Figure 4-9 Programming Setting in Options Window..... 33

Figure 4-10 Compile and Download the Project ..... 33

Figure 4-11 Keil MDK Debug Mode ..... 34

Figure 4-12 Debug Message on Serial Port Terminal Windows..... 34

Figure 4-13 IAR EWARM Window ..... 35

Figure 4-14 Compile and Download the Project ..... 35

Figure 4-15 IAR EWARM Debug Mode ..... 36

Figure 4-16 Debug Message on Serial Port Terminal Windows..... 36

Figure 4-17 Import the Project in NuEclipse ..... 37

Figure 4-18 Import Projects Windows..... 37

Figure 4-19 Build Project..... 38

Figure 4-20 Project Properties Settings ..... 38

Figure 4-21 Build Project..... 39

Figure 4-22 Open Debug Configuration ..... 39

Figure 4-23 Main Tab Configuration ..... 40

Figure 4-24 Debugger Tab Configuration ..... 40

Figure 4-25 Startup Tab Configuration ..... 41

Figure 4-26 NuEclipse Debug Mode ..... 42

Figure 4-27 Debug Message on Serial Port Terminal Windows ..... 42

Figure 5-1 Nu-Link2-Me Circuit ..... 43

Figure 5-2 M2354 Pin Assignment ..... 44

Figure 5-3 USB 2.0 FS OTG Circuit ..... 45

Figure 5-4 Power Circuit and Configurations ..... 46

Figure 5-5 MCU connector ..... 47

Figure 5-6 Arduino UNO Compatible Interface ..... 48

Figure 5-7 MicroSD Card Circuit ..... 49

Figure 5-8 Wi-Fi Module Circuit ..... 50

Figure 5-9 LCD interface Circuit ..... 51

Figure 5-10 Front Placement ..... 52

Figure 5-11 Rear Placement ..... 52

**List of Tables**

Table 3-1 Extension Connectors..... 11

Table 3-2 M2354KJFAE Full-pin Extension Connectors and GPIO Function List..... 16

Table 3-3 Arduino UNO Extension Connectors and M2354KJFAE Mapping GPIO List ..... 18

Table 3-4 Vin Power Source ..... 19

Table 3-5 5V Power Sources ..... 19

Table 3-6 3.3 V Power Sources ..... 20

Table 3-7 1.8V Power Sources ..... 20

Table 3-8 Power Connectors ..... 20

Table 3-9 USB Connectors ..... 20

Table 3-10 Power Switches ..... 21

Table 3-11 Supply External Power through Nu-Link2-Me ..... 22

Table 3-12 Supply External Power for M2354 target board..... 23

Table 3-13 External Reference Voltage Connector ..... 24

Table 3-14 Ammeter Connector..... 24

Table 3-15 Push-Buttons ..... 24

Table 3-16 LEDs ..... 25

Table 3-17 Optional Function of ESP-12 ..... 25

Table 3-18 VCOM Function of Nu-Link2-Me..... 27

Table 3-19 Status LEDs patterns of Nu-Link2-Me ..... 27

## 1 OVERVIEW

The NuMaker-M2354 is an evaluation board for Nuvoton NuMicro M2354 microcontrollers. The NuMaker-M2354 consists of two parts, a M2354 target board and an on-board Nu-Link2-Me debugger and programmer. The NuMaker-M2354 is designed for secure evaluation, prototype development and validation with power consumption monitoring function.

The M2354 target board is based on NuMicro M2354KJFAE. For the development flexibility, the M2354 target board provides the extension connectors of M2354KJFAE, the Arduino UNO compatible headers and is able to adopt multiple power supply by external power connectors. Furthermore, the Nuvoton-designed ammeter connector can measure the power consumption instantly, which is essential for the prototype evaluation. The M2354 target board also has Wi-Fi connectivity on board and LCD display panel (COM/SEG) for quick development.

In addition, there is an attached on-board debugger and programmer “Nu-Link2-Me”. The Nu-Link2-Me supports on-chip debugging, online and offline ICP programming via SWD interface. The Nu-Link2-Me supports virtual COM (VCOM) port for printing debug messages on PC. Besides, the programming status could be shown on the built-in LEDs. Lastly, the Nu-Link2-Me could be detached from the evaluation board and become a stand-alone mass production programmer.

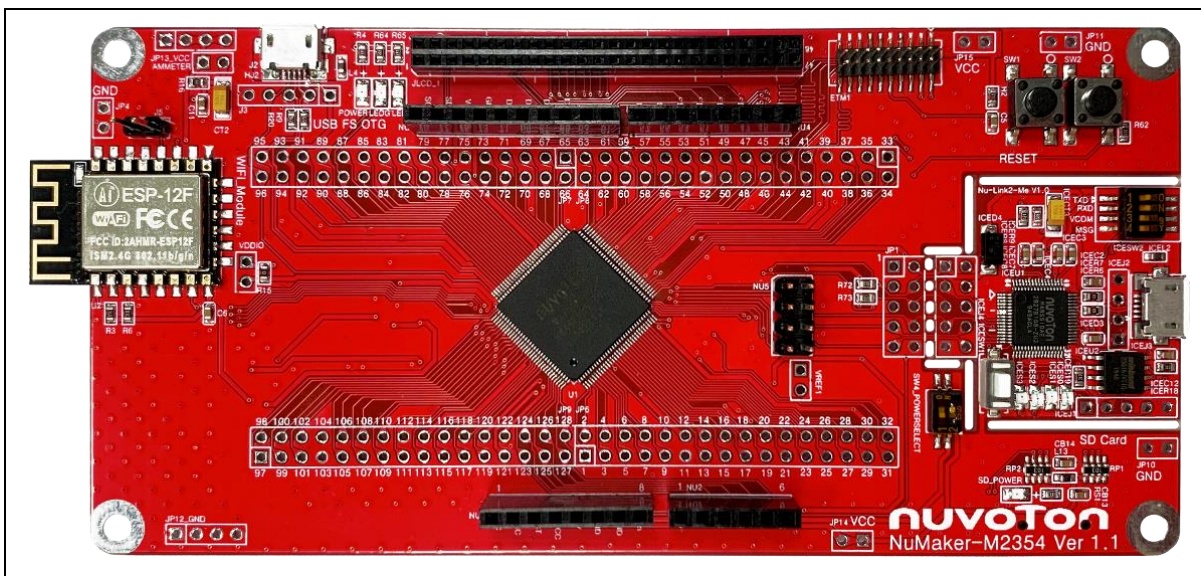

Figure 1-1 NuMaker-M2354 Board

## 2 FEATURES

- NuMicro M2354KJFAE microcontroller with function compatible with:
  - M2354LJFAE
  - M2354SJFAE
- M2354KJFAE extension connectors
- Arduino UNO compatible extension connectors
- COM/SEG LCD with panel
- ETM (embedded trace macrocell) debug interface for instruction and data tracing of a processor
- Wi-Fi module for wireless application
- MicroSD Card slot for T-Flash
- Ammeter connector for measuring the microcontroller's power consumption
- Flexible board power supply:
  - External  $V_{DD}$  power connector
  - Arduino UNO compatible extension connector  $V_{in}$
  - USB FS connector on M031 target board
  - ICE USB connector on Nu-Link2-Me
- On-board Nu-Link2-Me debugger and programmer:
  - Debug through SWD interface
  - Online/offline programming
  - Virtual COM port function



### 3 HARDWARE CONFIGURATION

#### 3.1 Front View

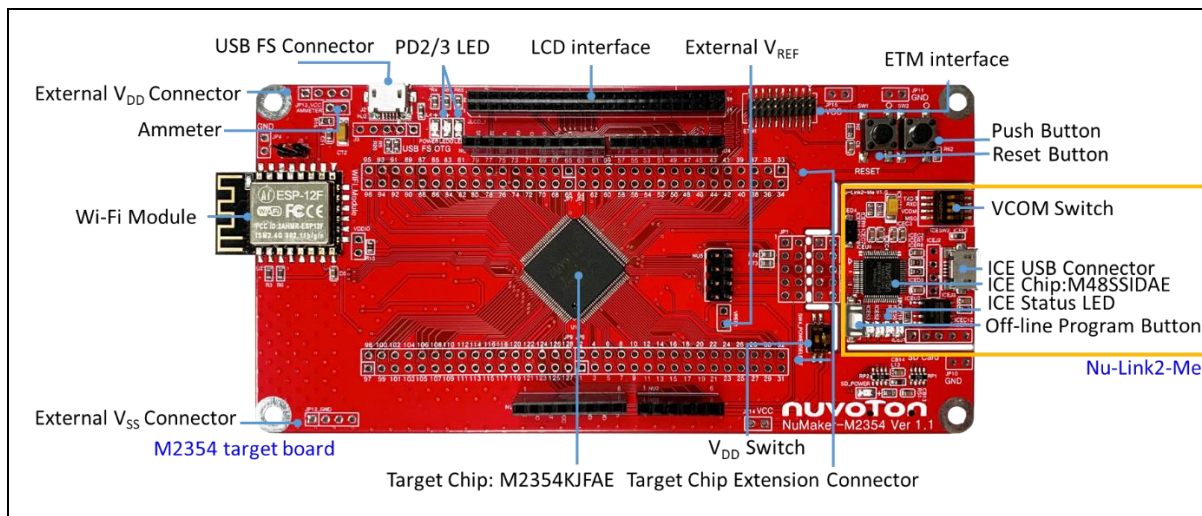

Figure 3-1 Front View of NuMaker-M2354

Figure 3-1 shows the main components and connectors from the front side of NuMaker-M2354. The following lists components and connectors from the front view:

- Target Chip: M2354KJFAE (U1)
- USB PWR Connector (J2)
- Arduino UNO Compatible Extension Connectors (NU1, NU2, NU3, NU4)
- M2354 Extension Connectors (JP6, JP7, JP8, JP9)
- External V<sub>DD</sub> Power Connector
- External V<sub>SS</sub> Power Connector
- External V<sub>REF</sub> Connector (VREF1)
- V<sub>DD</sub> Switch (SW4)
- Ammeter Connector (AMMETER)
- Reset Button (SW1) and push Button (SW2)
- Power LED and PD2/3 LED (LEDG1 and LEDR1)
- Wi-Fi Module
- COM/SEG LCD interface (JLCD)
- Nu-Link2-Me
  - VCOM Switch
  - ICE Chip: M48SSIDAE (ICEU2)
  - ICE USB Connector (ICEJ3)
  - ICE Status LED (ICES0, ICES1, ICES2, ICES3)
  - Off-line Program Button (ICESW1)

### 3.2 Rear View

Figure 3-2 shows the main components and connectors from the rear side of NuMaker-M2354.

The following lists components and connectors from the rear view:

- Nu-Link2-Me
  - MCUVCC Power Switch (ICEJPR1)
  - ICEVCC Power Switch (ICEJPR2)
- MicroSD Card Slot: T-Flash Slot

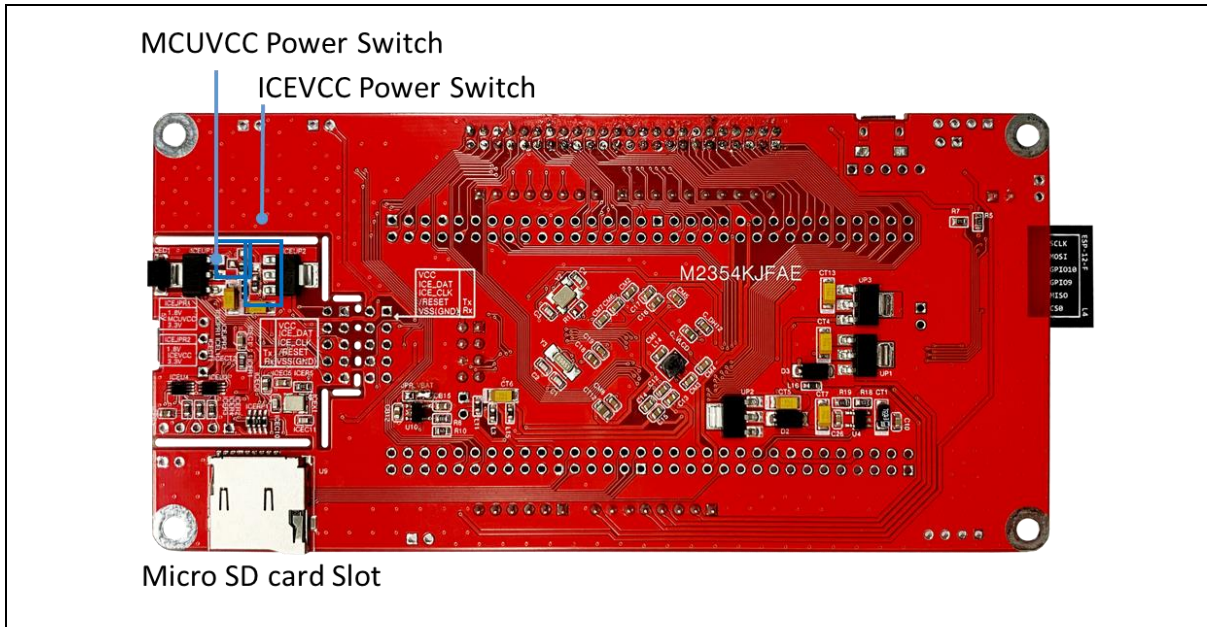

Figure 3-2 Rear View of NuMaker-M2354

### 3.3 Extension Connectors

Table 3-1 presents the extension connectors.

Connector	Description
JP6, JP7, JP8 and JP9	Full pins extension connectors on the NuMaker-M2354.
NU1, NU2, NU3 and NU4	Arduino UNO compatible pins on the NuMaker-M2354.

Table 3-1 Extension Connectors

#### 3.3.1 Pin Assignment for Extension Connectors

The NuMaker-M2354 provides the M2354 target chip on board and full pins extension connectors (JP6, JP7, JP8 and JP9). Figure 3-3 shows the M2354 extension connectors.

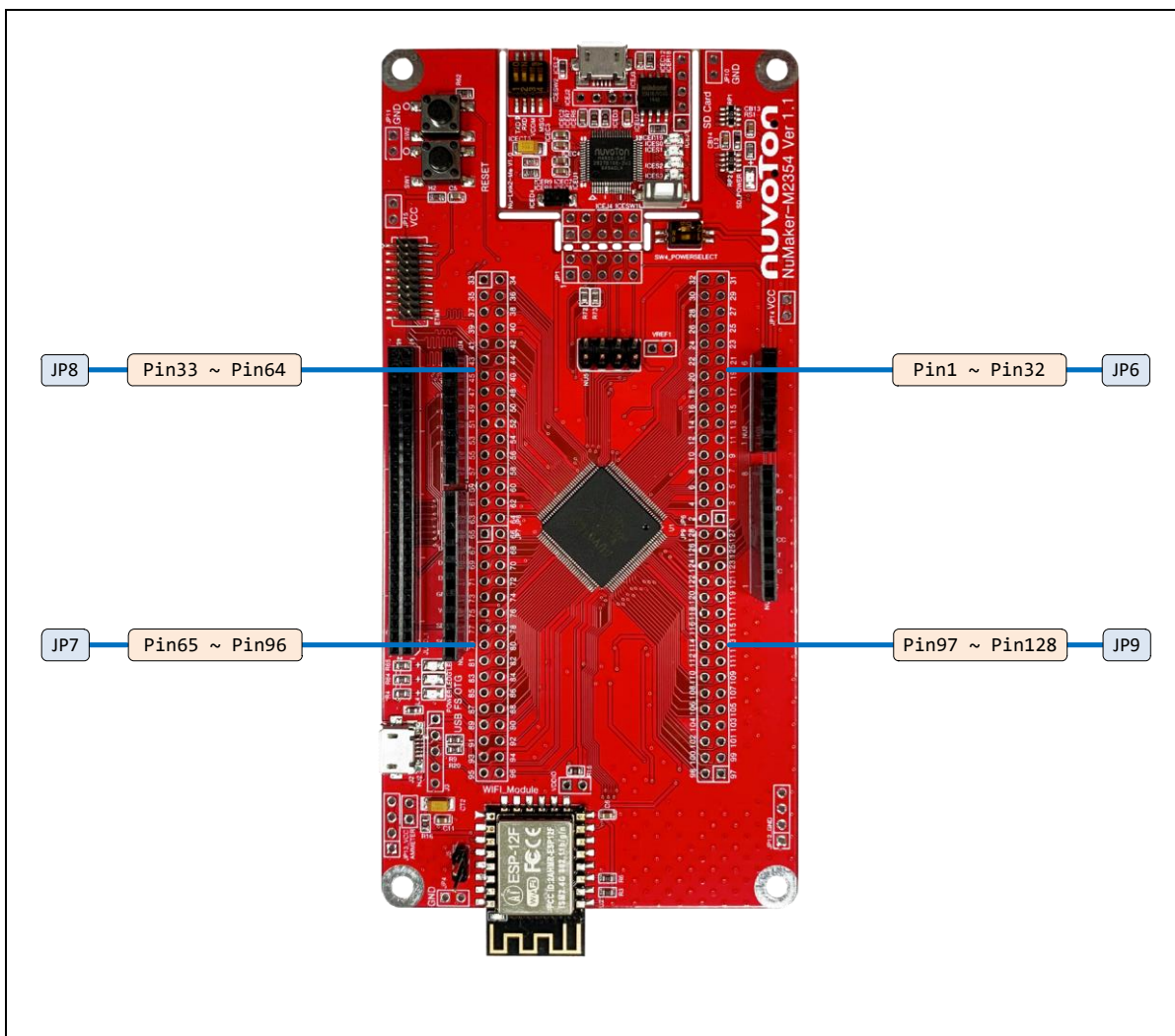

Figure 3-3 M2354 Extension Connectors

Header		M2354KJFAE	
		Pin No.	Function
JP6	JP6.1	1	PB.5 / EADC0_CH5 / ACMP1_N / EBI_ADR0 / SD0_DAT3 / SPI1_MISO / I2C0_SCL / UART5_TXD / USC11_CTL0 / SC0_CLK / I2S0_BCLK / EPWM0_CHO / UART2_TXD / TM0 / INT0
	JP6.2	2	PB.4 / EADC0_CH4 / ACMP1_P1 / EBI_ADR1 / SD0_DAT2 / SPI1_MOSI / I2C0_SDA / UART5_RXD / USC11_CTL1 / SC0_DAT / I2S0_MCLK / EPWM0_CH1 / UART2_RXD / TM1 / INT1
	JP6.3	3	PB.3 / EADC0_CH3 / ACMP0_N / EBI_ADR2 / SD0_DAT1 / SPI1_CLK / UART1_TXD / UART5_nRTS / USC11_DAT1 / SC0_RST / I2S0_DI / EPWM0_CH2 / I2C1_SCL / TM4 / TM2 / INT2
	JP6.4	4	PB.2 / EADC0_CH2 / ACMP0_P1 / EBI_ADR3 / SD0_DAT0 / SPI1_SS / UART1_RXD / UART5_nCTS / USC11_DAT0 / SC0_PWR / I2S0_DO / EPWM0_CH3 / I2C1_SDA / TM5 / TM3 / INT3
	JP6.5	5	PC.12 / EBI_ADR4 / UART0_TXD / I2C0_SCL / SPI3_MISO / SC0_nCD / ECAP1_IC2 / EPWM1_CHO / ACMP0_O
	JP6.6	6	PC.11 / EBI_ADR5 / UART0_RXD / I2C0_SDA / SPI3_MOSI / ECAP1_IC1 / EPWM1_CH1 / ACMP1_O
	JP6.7	7	PC.10 / EBI_ADR6 / SPI3_CLK / UART3_TXD / ECAP1_IC0 / EPWM1_CH2
	JP6.8	8	PC.9 / EBI_ADR7 / SPI3_SS / UART3_RXD / EPWM1_CH3
	JP6.9	9	PB.1 / EADC0_CH1 / EBI_ADR8 / SD0_CLK / SPI1_I2SMCLK / SPI3_I2SMCLK / UART2_TXD / USC11_CLK / I2C1_SCL / I2S0_LRCK / EPWM0_CH4 / EPWM1_CH4 / EPWM0_BRAKE0 / QSPI0_MISO1
	JP6.10	10	PB.0 / EADC0_CH0 / EBI_ADR9 / SD0_CMD / SPI2_I2SMCLK / UART2_RXD / SPI0_I2SMCLK / I2C1_SDA / EPWM0_CH5 / EPWM1_CH5 / EPWM0_BRAKE1 / QSPI0_MOSI1
	JP6.11	11	VSS
	JP6.12	12	VDD
	JP6.13	13	PA.11 / ACMP0_P0 / EBI_nRD / SC2_PWR / SPI2_SS / USC10_CLK / I2C2_SCL / BPWM0_CH0 / EPWM0_SYNC_OUT / TM0_EXT / DAC1_ST
	JP6.14	14	PA.10 / ACMP1_P0 / EBI_nWR / SC2_RST / SPI2_CLK / USC10_DAT0 / I2C2_SDA / BPWM0_CH1 / QE11_INDEX / ECAP0_IC0 / TM1_EXT / DAC0_ST
	JP6.15	15	PA.9 / EBI_MCLK / SC2_DAT / SPI2_MISO / USC10_DAT1 / UART1_TXD / BPWM0_CH2 / QE11_A / ECAP0_IC1 / TM4_EXT / TM2_EXT
	JP6.16	16	PA.8 / EBI_ALE / SC2_CLK / SPI2_MOSI / USC10_CTL1 / UART1_RXD / BPWM0_CH3 / QE11_B / ECAP0_IC2 / TM5_EXT / TM3_EXT / INT4
	JP6.17	17	PC.13 / EBI_ADR10 / SC2_nCD / SPI2_I2SMCLK / USC10_CTL0 / UART2_TXD / BPWM0_CH4 / CLKO / EADC0_ST
	JP6.18	18	PD.12 / EBI_nCS0 / UART2_RXD / BPWM0_CH5 / QE10_INDEX / CLKO / EADC0_ST / INT5
	JP6.19	19	PD.11 / EBI_nCS1 / UART1_TXD / CAN0_TXD / QE10_A / INT6
	JP6.20	20	PD.10 / EBI_nCS2 / UART1_RXD / CAN0_RXD / QE10_B / INT7
	JP6.21	21	PG.2 / EBI_ADR11 / SPI2_SS / I2C0_SMBAL / I2C1_SCL / TM0 / LCD_SEG39
	JP6.22	22	PG.3 / EBI_ADR12 / SPI2_CLK / I2C0_SMBUS / I2C1_SDA / TM1 / LCD_SEG38
	JP6.23	23	PG.4 / EBI_ADR13 / SPI2_MISO / TM4 / TM2 / LCD_SEG37
	JP6.24	24	PF.11 / EBI_ADR14 / SPI2_MOSI / UART5_TXD / TAMPER5 / TM5 / TM3
	JP6.25	25	PF.10 / EBI_ADR15 / SC0_nCD / I2S0_BCLK / SPI0_I2SMCLK / UART5_RXD / TAMPER4
	JP6.26	26	PF.9 / EBI_ADR16 / SC0_PWR / I2S0_MCLK / SPI0_SS / UART5_nRTS / TAMPER3
	JP6.27	27	PF.8 / EBI_ADR17 / SC0_RST / I2S0_DI / SPI0_CLK / UART5_nCTS / TAMPER2
	JP6.28	28	PF.7 / EBI_ADR18 / SC0_DAT / I2S0_DO / SPI0_MISO / UART4_TXD / TAMPER1
	JP6.29	29	PF.6 / EBI_ADR19 / SC0_CLK / I2S0_LRCK / SPI0_MOSI / UART4_RXD / EBI_nCS0 / SPI3_I2SMCLK / TAMPER0
	JP6.30	30	VBAT
	JP6.31	31	PF.5 / UART2_RXD / UART2_nCTS / EPWM0_CH0 / BPWM0_CH4 / EPWM0_SYNC_OUT / X32_IN / EADC0_ST



Header		M2354KJFAE	
		Pin No.	Function
	JP6.32	32	PF.4 / UART2_TXD / UART2_nRTS / EPWM0_CH1 / BPWM0_CH5 / X32_OUT
JP8	JP8.1	33	PH.4 / EBI_ADR3 / SPI1_MISO / LCD_SEG36
	JP8.2	34	PH.5 / EBI_ADR2 / SPI1_MOSI / LCD_SEG35
	JP8.3	35	PH.6 / EBI_ADR1 / SPI1_CLK / LCD_SEG34
	JP8.4	36	PH.7 / EBI_ADR0 / SPI1_SS / LCD_SEG33
	JP8.5	37	PF.3 / EBI_nCS0 / UART0_TXD / I2C0_SCL / XT1_IN / BPWM1_CH0
	JP8.6	38	PF.2 / EBI_nCS1 / UART0_RXD / I2C0_SDA / QSPI0_CLK / XT1_OUT / BPWM1_CH1
	JP8.7	39	VSS
	JP8.8	40	VDD
	JP8.9	41	PE.8 / EBI_ADR10 / I2S0_BCLK / SPI2_CLK / USC1_CTL1 / UART2_TXD / EPWM0_CH0 / EPWM0_BRAKE0 / ECAP0_IC0 / TRACE_DATA3 / LCD_SEG32
	JP8.10	42	PE.9 / EBI_ADR11 / I2S0_MCLK / SPI2_MISO / USC1_CTL0 / UART2_RXD / EPWM0_CH1 / EPWM0_BRAKE1 / ECAP0_IC1 / TRACE_DATA2 / LCD_SEG31
	JP8.11	43	PE.10 / EBI_ADR12 / I2S0_DI / SPI2_MOSI / USC1_DAT0 / UART3_TXD / EPWM0_CH2 / EPWM1_BRAKE0 / ECAP0_IC2 / TRACE_DATA1 / LCD_SEG30
	JP8.12	44	PE.11 / EBI_ADR13 / I2S0_DO / SPI2_SS / USC1_DAT1 / UART3_RXD / UART1_nCTS / EPWM0_CH3 / EPWM1_BRAKE1 / ECAP1_IC2 / TRACE_DATA0
	JP8.13	45	PE.12 / EBI_ADR14 / I2S0_LRCK / SPI2_I2SMCLK / USC1_CLK / UART1_nRTS / EPWM0_CH4 / ECAP1_IC1 / TRACE_CLK
	JP8.14	46	PE.13 / EBI_ADR15 / I2C0_SCL / UART4_nRTS / UART1_TXD / EPWM0_CH5 / EPWM1_CH0 / BPWM1_CH5 / ECAP1_IC0
	JP8.15	47	PC.8 / EBI_ADR16 / I2C0_SDA / UART4_nCTS / UART1_RXD / EPWM1_CH1 / BPWM1_CH4
	JP8.16	48	PC.7 / EBI_AD9 / SPI1_MISO / UART4_TXD / SC2_PWR / UART0_nCTS / I2C1_SMBAL / EPWM1_CH2 / BPWM1_CH0 / TM0 / INT3
	JP8.17	49	PC.6 / EBI_AD8 / SPI1_MOSI / UART4_RXD / SC2_RST / UART0_nRTS / I2C1_SMBUS / EPWM1_CH3 / BPWM1_CH1 / TM1 / INT2
	JP8.18	50	PA.7 / EBI_AD7 / SPI1_CLK / SC2_DAT / UART0_TXD / I2C1_SCL / TM4 / EPWM1_CH4 / BPWM1_CH2 / ACMP0_WLAT / TM2 / INT1
	JP8.19	51	PA.6 / EBI_AD6 / SPI1_SS / SC2_CLK / UART0_RXD / I2C1_SDA / TM5 / EPWM1_CH5 / BPWM1_CH3 / ACMP1_WLAT / TM3 / INTO
	JP8.20	52	VSS
	JP8.21	53	VDD
	JP8.22	54	LDO_CAP
	JP8.23	55	PA.5 / QSPI0_MISO1 / SPI1_I2SMCLK / SC2_nCD / UART0_nCTS / UART5_TXD / I2C0_SCL / CAN0_TXD / UART0_TXD / BPWM0_CH5 / EPWM0_CH0 / QEIO_INDEX / LCD_SEG29
	JP8.24	56	PA.4 / QSPI0_MOSI1 / SPI0_I2SMCLK / SC0_nCD / UART0_nRTS / UART5_RXD / I2C0_SDA / CAN0_RXD / UART0_RXD / BPWM0_CH4 / EPWM0_CH1 / QEIO_A / LCD_SEG28
	JP8.25	57	PA.3 / QSPI0_SS / SPI0_SS / SC0_PWR / UART4_TXD / UART1_TXD / I2C1_SCL / I2C0_SMBAL / LCD_SEG27 / BPWM0_CH3 / EPWM0_CH2 / QEIO_B / EPWM1_BRAKE1
	JP8.26	58	PA.2 / QSPI0_CLK / SPI0_CLK / SC0_RST / UART4_RXD / UART1_RXD / I2C1_SDA / I2C0_SMBUS / LCD_SEG26 / BPWM0_CH2 / EPWM0_CH3
	JP8.27	59	PA.1 / QSPI0_MISO0 / SPI0_MISO / SC0_DAT / UART0_TXD / UART1_nCTS / I2C2_SCL / LCD_SEG25 / BPWM0_CH1 / EPWM0_CH4 / DAC1_ST
	JP8.28	60	PA.0 / QSPI0_MOSI0 / SPI0_MOSI / SC0_CLK / UART0_RXD / UART1_nRTS / I2C2_SDA / LCD_SEG24 / BPWM0_CH0 / EPWM0_CH5 / DAC0_ST
	JP8.29	61	VDDIO
	JP8.30	62	PE.14 / EBI_AD8 / UART2_TXD / CAN0_TXD / LCD_SEG23
	JP8.31	63	PE.15 / EBI_AD9 / UART2_RXD / CAN0_RXD / LCD_SEG22

Header		M2354KJFAE	
		Pin No.	Function
	JP8.32	64	nRESET
JP7	JP7.1	65	PF.0 / UART1_TXD / I2C1_SCL / UART0_TXD / BPWM1_CH0 / ICE_DAT
	JP7.2	66	PF.1 / UART1_RXD / I2C1_SDA / UART0_RXD / BPWM1_CH1 / ICE_CLK
	JP7.3	67	PD.9 / EBI_AD7 / I2C2_SCL / UART2_nCTS / LCD_COM7/SEG40
	JP7.4	68	PD.8 / EBI_AD6 / I2C2_SDA / UART2_nRTS / LCD_COM6/SEG41
	JP7.5	69	PC.5 / EBI_AD5 / QSPI0_MISO1 / UART2_TXD / I2C1_SCL / CAN0_TXD / UART4_TXD / EPWM1_CH0 / LCD_COM5/SEG42
	JP7.6	70	PC.4 / EBI_AD4 / QSPI0_MOSI1 / SC1_nCD / I2S0_BCLK / SPI1_I2SMCLK / UART2_RXD / I2C1_SDA / CAN0_RXD / UART4_RXD / EPWM1_CH1 / LCD_COM4/SEG43
	JP7.7	71	PC.3 / EBI_AD3 / QSPI0_SS / SC1_PWR / I2S0_MCLK / SPI1_MISO / UART2_nRTS / I2C0_SMBAL / UART3_TXD / EPWM1_CH2 / LCD_COM3
	JP7.8	72	PC.2 / EBI_AD2 / QSPI0_CLK / SC1_RST / I2S0_DI / SPI1_MOSI / UART2_nCTS / I2C0_SMBUS / UART3_RXD / EPWM1_CH3 / LCD_COM2
	JP7.9	73	PC.1 / EBI_AD1 / QSPI0_MISO0 / SC1_DAT / I2S0_DO / SPI1_CLK / UART2_TXD / I2C0_SCL / EPWM1_CH4 / LCD_COM1 / ACMP0_O / EADC0_ST
	JP7.10	74	PC.0 / EBI_AD0 / QSPI0_MOSI0 / SC1_CLK / I2S0_LRCK / SPI1_SS / UART2_RXD / I2C0_SDA / EPWM1_CH5 / LCD_COM0 / ACMP1_O
	JP7.11	75	VSS
	JP7.12	76	VDD
	JP7.13	77	PG.9 / EBI_AD0 / BPWM0_CH5 / LCD_SEG21
	JP7.14	78	PG.10 / EBI_AD1 / BPWM0_CH4 / LCD_SEG20
	JP7.15	79	PG.11 / EBI_AD2 / BPWM0_CH3 / LCD_SEG19
	JP7.16	80	PG.12 / EBI_AD3 / BPWM0_CH2 / LCD_SEG18
	JP7.17	81	PG.13 / EBI_AD4 / BPWM0_CH1 / LCD_SEG17
	JP7.18	82	PG.14 / EBI_AD5 / BPWM0_CH0 / LCD_SEG16
	JP7.19	83	PG.15 / LCD_SEG15 / CLKO / EADC0_ST
	JP7.20	84	PD.7 / UART1_TXD / I2C0_SCL / SPI1_MISO / USCI1_CLK / SC1_PWR / LCD_SEG14
	JP7.21	85	PD.6 / UART1_RXD / I2C0_SDA / SPI1_MOSI / USCI1_DAT1 / SC1_RST / LCD_SEG13
	JP7.22	86	PD.5 / I2C1_SCL / SPI1_CLK / USCI1_DAT0 / SC1_DAT
	JP7.23	87	PD.4 / USCI0_CTL0 / I2C1_SDA / SPI1_SS / USCI1_CTL1 / SC1_CLK / USB_VBUS_ST
	JP7.24	88	PD.3 / EBI_AD10 / USCI0_CTL1 / SPI0_SS / UART3_nRTS / USCI1_CTL0 / SC2_PWR / SC1_nCD / UART0_TXD
	JP7.25	89	PD.2 / EBI_AD11 / USCI0_DAT1 / SPI0_CLK / UART3_nCTS / SC2_RST / UART0_RXD
	JP7.26	90	PD.1 / EBI_AD12 / USCI0_DAT0 / SPI0_MISO / UART3_TXD / I2C2_SCL / SC2_DAT
	JP7.27	91	PD.0 / EBI_AD13 / USCI0_CLK / SPI0_MOSI / UART3_RXD / I2C2_SDA / SC2_CLK / TM2
	JP7.28	92	VLCD
	JP7.29	93	PA.12 / I2S0_BCLK / UART4_TXD / I2C1_SCL / SPI2_SS / CAN0_TXD / SC2_PWR / BPWM1_CH2 / QEI1_INDEX / USB_VBUS
	JP7.30	94	PA.13 / I2S0_MCLK / UART4_RXD / I2C1_SDA / SPI2_CLK / CAN0_RXD / SC2_RST / BPWM1_CH3 / QEI1_A / USB_D-
	JP7.31	95	PA.14 / I2S0_DI / UART0_TXD / SPI2_MISO / I2C2_SCL / SC2_DAT / BPWM1_CH4 / QEI1_B / USB_D+
	JP7.32	96	PA.15 / I2S0_DO / UART0_RXD / SPI2_MOSI / I2C2_SDA / SC2_CLK / BPWM1_CH5 / EPWM0_SYNC_IN / USB_OTG_ID
JP9	JP9.1	97	PE.7 / SD0_CMD / UART5_TXD / QEI1_INDEX / EPWM0_CH0 / BPWM0_CH5 / LCD_SEG12

Header		M2354KJFAE	
		Pin No.	Function
JP9.2	98	PE.6 / SD0_CLK / SPI3_I2SMCLK / SC0_nCD / USCI0_CTL0 / UART5_RXD / QEI1_A / EPWM0_CH1 / BPWM0_CH4 / LCD_SEG11	
JP9.3	99	PE.5 / EBI_nRD / SD0_DAT3 / SPI3_SS / SC0_PWR / USCI0_CTL1 / QEI1_B / EPWM0_CH2 / BPWM0_CH3 / LCD_SEG10	
JP9.4	100	PE.4 / EBI_nWR / SD0_DAT2 / SPI3_CLK / SC0_RST / USCI0_DAT1 / QEI0_INDEX / EPWM0_CH3 / BPWM0_CH2 / LCD_SEG9	
JP9.5	101	PE.3 / EBI_MCLK / SD0_DAT1 / SPI3_MISO / SC0_DAT / USCI0_DAT0 / QEI0_A / EPWM0_CH4 / BPWM0_CH1 / LCD_SEG8	
JP9.6	102	PE.2 / EBI_ALE / SD0_DAT0 / SPI3_MOSI / SC0_CLK / USCI0_CLK / QEI0_B / EPWM0_CH5 / BPWM0_CH0 / LCD_SEG7	
JP9.7	103	VSS	
JP9.8	104	VDD	
JP9.9	105	PE.1 / EBI_AD10 / QSPIO_MISO0 / SC2_DAT / I2S0_BCLK / SPI1_MISO / UART3_TXD / I2C1_SCL / UART4_nCTS / LCD_SEG6	
JP9.10	106	PE.0 / EBI_AD11 / QSPIO_MOSI0 / SC2_CLK / I2S0_MCLK / SPI1_MOSI / UART3_RXD / I2C1_SDA / UART4_nRTS / LCD_SEG5	
JP9.11	107	PH.8 / EBI_AD12 / QSPIO_CLK / SC2_PWR / I2S0_DI / SPI1_CLK / UART3_nRTS / I2C1_SMBAL / I2C2_SCL / UART1_TXD / LCD_SEG4	
JP9.12	108	PH.9 / EBI_AD13 / QSPIO_SS / SC2_RST / I2S0_DO / SPI1_SS / UART3_nCTS / I2C1_SMBSUS / I2C2_SDA / UART1_RXD / LCD_SEG3	
JP9.13	109	PH.10 / EBI_AD14 / QSPIO_MISO1 / SC2_nCD / I2S0_LRCK / SPI1_I2SMCLK / UART4_TXD / UART0_TXD / LCD_SEG2	
JP9.14	110	PH.11 / EBI_AD15 / QSPIO_MOSI1 / UART4_RXD / UART0_RXD / EPWM0_CH5 / LCD_SEG1	
JP9.15	111	PD.14 / EBI_nCS0 / SPI3_I2SMCLK / SC1_nCD / USCI0_CTL0 / SPI0_I2SMCLK / EPWM0_CH4 / LCD_SEG0	
JP9.16	112	VSS	
JP9.17	113	Vsw	
JP9.18	114	VDD	
JP9.19	115	LDO_CAP	
JP9.20	116	PB.15 / EADC0_CH15 / EBI_AD12 / SC1_PWR / SPI0_SS / USCI0_CTL1 / UART0_nCTS / UART3_TXD / I2C2_SMBAL / EPWM1_CH0 / TMO_EXT / USB_VBUS_EN	
JP9.21	117	PB.14 / EADC0_CH14 / EBI_AD13 / SC1_RST / SPI0_CLK / USCI0_DAT1 / UART0_nRTS / UART3_RXD / I2C2_SMBSUS / EPWM0_BRAKE1 / EPWM1_CH1 / TM1_EXT / CLKO / USB_VBUS_ST	
JP9.22	118	PB.13 / EADC0_CH13 / DAC1_OUT / ACMP0_P3 / ACMP1_P3 / EBI_AD14 / SC1_DAT / SPI0_MISO / USCI0_DAT0 / UART0_TXD / UART3_nRTS / I2C2_SCL / EPWM1_CH2 / TM2_EXT / TM4_EXT	
JP9.23	119	PB.12 / EADC0_CH12 / DAC0_OUT / ACMP0_P2 / ACMP1_P2 / EBI_AD15 / SC1_CLK / SPI0_MOSI / USCI0_CLK / UART0_RXD / UART3_nCTS / I2C2_SDA / SD0_nCD / EPWM1_CH3 / TM3_EXT / TM5_EXT	
JP9.24	120	AVDD	
JP9.25	121	VREF	
JP9.26	122	AVSS	
JP9.27	123	PB.11 / EADC0_CH11 / EBI_ADR16 / UART0_nCTS / UART4_TXD / I2C1_SCL / CAN0_TXD / SPI0_I2SMCLK / BPWM1_CH0 / SPI3_CLK	
JP9.28	124	PB.10 / EADC0_CH10 / EBI_ADR17 / USCI1_CTL0 / UART0_nRTS / UART4_RXD / I2C1_SDA / CAN0_RXD / BPWM1_CH1 / SPI3_SS	
JP9.29	125	PB.9 / EADC0_CH9 / EBI_ADR18 / USCI1_CTL1 / UART0_TXD / UART1_nCTS / I2C1_SMBAL / I2C0_SCL / BPWM1_CH2 / SPI3_MISO / INT7	
JP9.30	126	PB.8 / EADC0_CH8 / EBI_ADR19 / USCI1_CLK / UART0_RXD / UART1_nRTS / I2C1_SMBSUS / I2C0_SDA / BPWM1_CH3 / SPI3_MOSI / INT6	
JP9.31	127	PB.7 / EADC0_CH7 / EBI_nWRL / USCI1_DAT0 / UART1_TXD / EBI_nCS0 / BPWM1_CH4 / EPWM1_BRAKE0 / EPWM1_CH4 / INT5 / USB_VBUS_ST / ACMP0_O	

Header		M2354KJFAE	
		Pin No.	Function
JP9.32	128	PB.6 / EADC0_CH6 / EBI_nWRH / USCI1_DAT1 / UART1_RXD / EBI_nCS1 / BPWM1_CH5 / EPWM1_BRAKE1 / EPWM1_CH5 / INT4 / USB_VBUS_EN / ACMP1_O	

Table 3-2 M2354KJFAE Full-pin Extension Connectors and GPIO Function List



### 3.3.2 Arduino UNO Compatible Extension Connectors

Figure 3-4 shows the Arduino UNO compatible extension connectors.

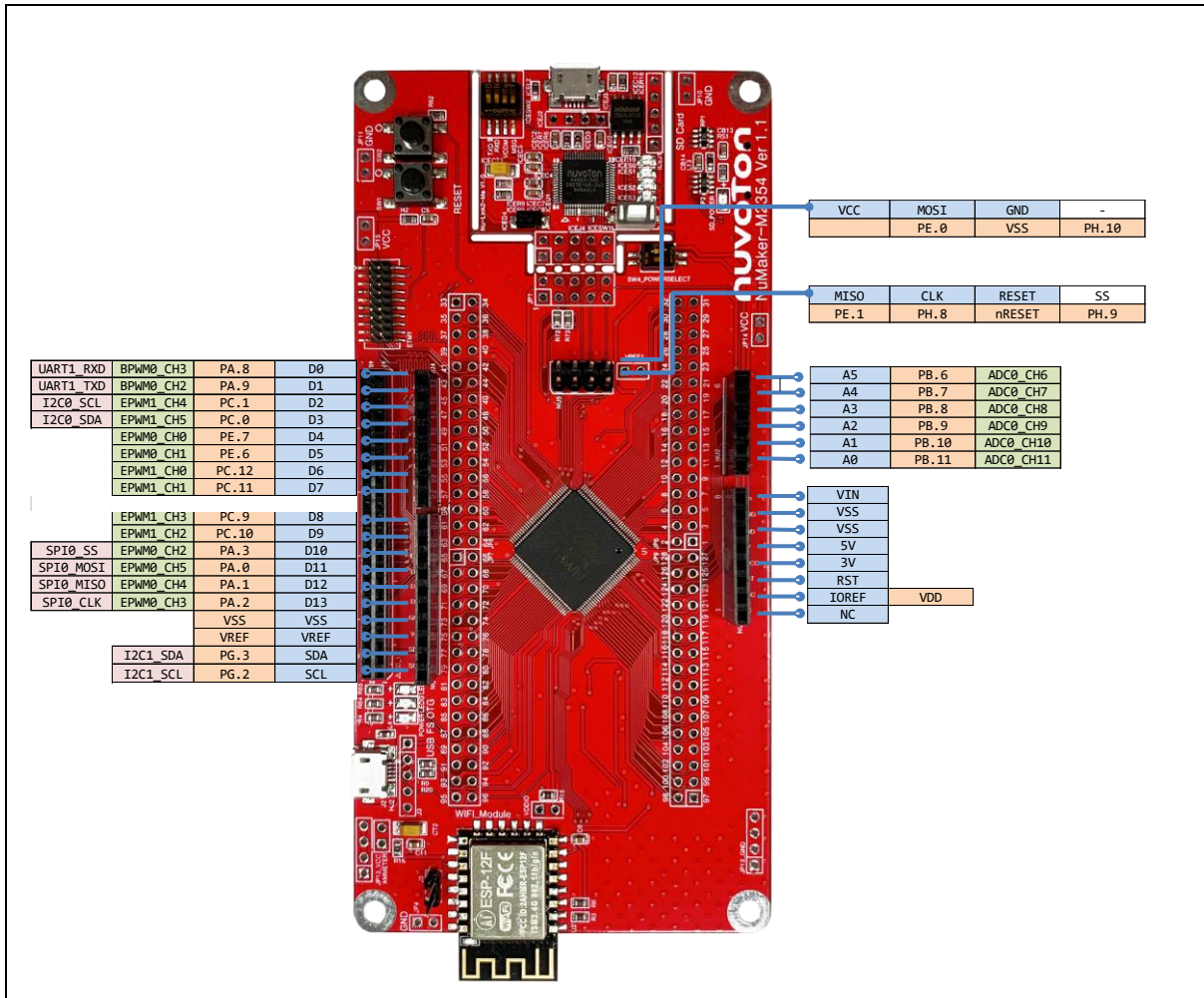

Figure 3-4 Arduino UNO Compatible Extension Connectors

Header		NuMaker-M2354		Header		NuMaker-M2354	
		Compatible to Arduino UNO	GPIO Pin of M2354			Compatible to Arduino UNO	GPIO Pin of M2354
NU4	NU4.1	D0	PA.8	NU2	NU2.6	A5	PB.6
	NU4.2	D1	PA.9		NU2.5	A4	PB.7
	NU4.3	D2	PC.1		NU2.4	A3	PB.8
	NU4.4	D3	PC.0		NU2.3	A2	PB.9
	NU4.5	D4	PE.7		NU2.2	A1	PB.10
	NU4.6	D5	PE.6		NU2.1	A0	PB.11
	NU4.7	D6	PC.12	NU1	NU1.8	VIN	-
	NU4.8	D7	PC.11		NU1.7	VSS	
NU3	NU3.1	D8	PC.9		NU1.6	VSS	
	NU3.2	D9	PC10		NU1.5	5V	
	NU3.3	D10	PA.3	NU1.4	3V		
	NU3.4	D11	PA.0	NU1.3	RST	nRESET	
	NU3.5	D12	PA.1	NU1.2	IOREF	V <sub>DD</sub>	
	NU3.6	D13	PA.2	NU1.1	NC	-	
	NU3.7	AVSS	GND				
	NU3.8	VREF	V <sub>REF</sub>				
	NU3.9	SDA	PG.3				
	NU3.10	SCL	PG.2				

Table 3-3 Arduino UNO Extension Connectors and M2354KJFAE Mapping GPIO List

### 3.4 Power Supply Configuration

The NuMaker-M2354 is able to adopt multiple power supply. External power source includes NU1 Vin (7 V to 12 V), V<sub>DD</sub> (depends on target chip operating voltage), and PC through USB connector. By using switches and voltage regulator, multiple power domains can be created on the NuMaker-M2354.

#### 3.4.1 VIN Power Source

Table 3-4 presents the Vin power source.

Connector	Net Name in Schematic	Comment
NU1 pin8	NU1_VIN	Board external power source, with voltage range from 7 V to 12 V. The voltage regulator UP2 converts the NU1 pin8 input voltage to 5V and supplies it to NuMaker-M2354.

Table 3-4 Vin Power Source

#### 3.4.2 5V Power Sources

Table 3-5 presents the 5 V power sources.

Connector	Net Name in Schematic	Comment
ICEJ3	USB_HS_VBUS	ICE USB connector supplies 5 V power from PC to M2354 target board and Nu-Link2-Me.
J2	USB_VBUS	USB connector on NuMaker-M2354 supplies 5 V power from PC to M2354 target board and Nu-Link2-Me.
NU1 pin5	NU1_5VCC	ICEJ3, J2 or NU1 pin8 supplies 5 V power to NU1 pin5. NU1 pin5 supplies 5 V power to the target chip or Arduino adapter board. <b>Note:</b> The M2354 operating voltage range is from 1.7 V to 3.6 V. Do not switch SW2.1 (NU1 5VCC) to ON.

Table 3-5 5V Power Sources

#### 3.4.3 3.3 V Power Sources

Table 3-6 presents the 3.3 V power sources.

Voltage Regulator	5V Source	Comment
ICEUP1	USB_HS_VBUS	ICEUP1 converts USB_HS_VBUS to 3.3 V and supplies 3.3V to M2354 target board or ICE chip.
UP1	USB_VBUS	UP1 converts USB_VBUS to 3.3 V and supplies 3.3 V to M2354 target board. <b>Note:</b> SW4.1(NU1 3VCC) should be switched to ON.

UP1	NU1_5VCC	UP1 converts NU1_5VCC to 3.3 V and supplies 3.3 V to M2354 target board. <b>Note:</b> SW4.1(NU1 3VCC) should be switched to ON.
-----	----------	--

Table 3-6 3.3 V Power Sources

### 3.4.4 1.8V Power Sources

Table 3-7 presents the 1.8 V power source.

Voltage Regular	5V Source	Comment
ICEUP2	USB_HS_VBUS	ICEUP2 converts USB_HS_VBUS to 1.8V and supplies 1.8V to M2354 target board or ICE chip.
UP3	NU1_5VCC	UP3 converts NU1_5VCC to 1.8V and supplies 1.8V to internal V <sub>DDIO</sub> pin.

Table 3-7 1.8V Power Sources

### 3.4.5 Power Connectors

Table 3-8 presents the power connectors.

Connector	Comment
JP13,JP14,JP15	V <sub>DD</sub> connector on the NuMaker-M2354. <b>Note:</b> M2354 operating voltage range is from 1.7 V to 3.6 V.
JP4, JP5, JP10 and JP11,JP12	V <sub>SS</sub> connector on the NuMaker-M2354.
JPR_VBAT	V <sub>BAT</sub> connector on the NuMaker-M2354.

Table 3-8 Power Connectors

### 3.4.6 USB Connectors

Table 3-9 presents the USB connectors.

Connector	Comment
ICEJ3	ICE USB connector on Nu-Link2-Me for power supply, debugging and programming from PC.
J2	USB FS connector on NuMaker-M2354 for power supply.

Table 3-9 USB Connectors

### 3.4.7 Power Switches

Table 3-10 presents the power switches.

Switch	Comment
--------	---------

ICEJPR1	Configures the target chip operating voltage at 1.8 V / 3.3 V / 5 V. <b>Note:</b> M2354 operating voltage range is from 1.7 V to 3.6 V. Do not switch ICEJPR1 (MCUVCC) to 5 V.
ICEJPR2	Configures the ICE chip operating voltage at 1.8 V / 3.3 V.
SW4_PowerSelect	Configures the target chip power source from ICE or NU1_3VCC.

Table 3-10 Power Switches

### 3.4.8 Power Supply Models

#### 3.4.8.1 External Power Supply through Nu-Link2-Me to Target Chip

The external power supply source on Nu-Link2-Me is shown in Figure 3-5.

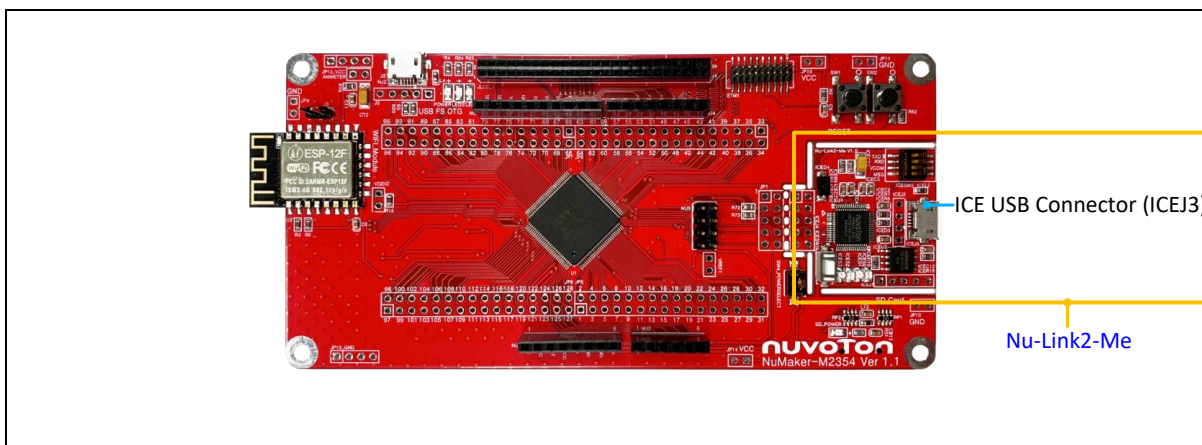

Figure 3-5 External Power Supply Sources on Nu-Link2-Me

To use ICEJ3 as external power supply source with Nu-Link2-Me, please follow the steps below:

1. Solder the resistor on ICEJPR1 (MCUVCC) depends on the target chip operating voltage.
2. Solder the resistor on ICEJPR2 (ICEVCC) depends on the ICE chip operating voltage.
3. Connect the external power supply to ICEJ3.

Table 3-11 presents all power models when supplying external power through Nu-Link2-Me. The Nu-Link2-Me external power sources are highlighted in yellow.

Model	Target Chip Voltage	ICEJ3	ICEJPR1 (MCUVCC) Selection <sup>[1]</sup>	ICEJPR2 (ICEVCC) Selection <sup>[2]</sup>	ICE Chip Voltage	SW4 Selection	J2	Vin	JP13
1	1.8 V	Connect to PC	1.8 V	1.8 V	1.8 V	Off	-	-	1.8 V output
2	3.3 V	Connect to PC	3.3 V (default)	3.3 V (default)	3.3 V	Off	-	-	3.3 V output
3	5 V	Connect to PC	5V	3.3 V (default)	3.3 V	Off	-	-	5 V output
-: Unused. <b>Note:</b>									

	<ol style="list-style-type: none"> <li>1. 0 Ω should be soldered between ICEJPR1's MCUVCC and 1.8 V / 3.3 V / 5 V.</li> <li>2. 0 Ω should be soldered between ICEJPR2's ICEVCC and 1.8 V / 3.3 V.</li> </ol>
--	--

Table 3-11 Supply External Power through Nu-Link2-Me

### 3.4.8.2 External Power Supply through M2354 target board to Target Chip

The external power supply sources on M2354 target board are shown in Figure 3-6.

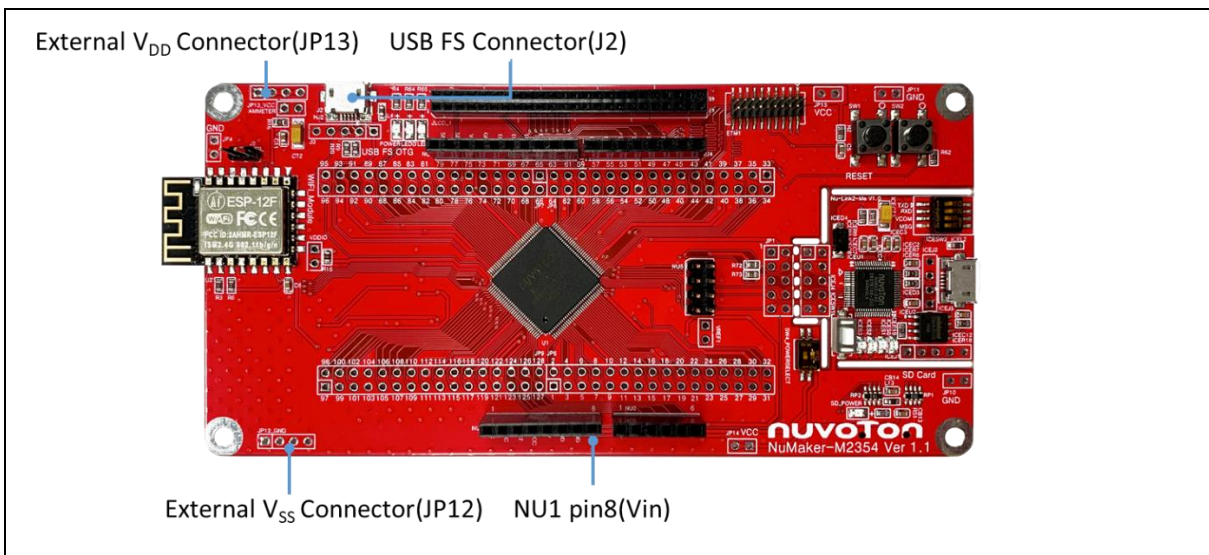

Figure 3-6 External Power Supply Sources on M2354 target board

To use Vin or J2 as external power supply source, please follow the steps below:

1. Switch the SW4.2 to ON.
2. Remove the resistor on ICEJPR1 (MCUVCC).
3. Solder the resistor on ICEJPR2 (ICEVCC) depends on the ICE chip operating voltage.
4. Connect the external power supply to Vin or J2.

To use JP13/JP14/JP15 as external power supply source, please follow the steps below:

1. Switch the SW4 to OFF.
2. Remove the resistor on ICEJPR1 (MCUVCC).
3. Solder the resistor on ICEJPR2 (ICEVCC) depends on the ICE chip operating voltage.
4. Connect ICEJ3 to PC.
5. Connect the external power supply to JP13.

To use Vin or J2 as external power supply source with Nu-Link2-Me separated from NuMaker-M2354, please follow the steps below:

1. Switch the SW4.2 to ON.
2. Separate the Nu-Link2-Me from NuMaker-M2354.
3. Connect the external power supply to Vin or J2.



To use JP13/JP14/JP15 as external power supply source with Nu-Link2-Me separated from NuMaker-M2354, please follow the steps below:

1. Switch the SW4 to OFF.
2. Separate the Nu-Link2-Me from NuMaker-M2354.
3. Connect the external power supply to JP13.

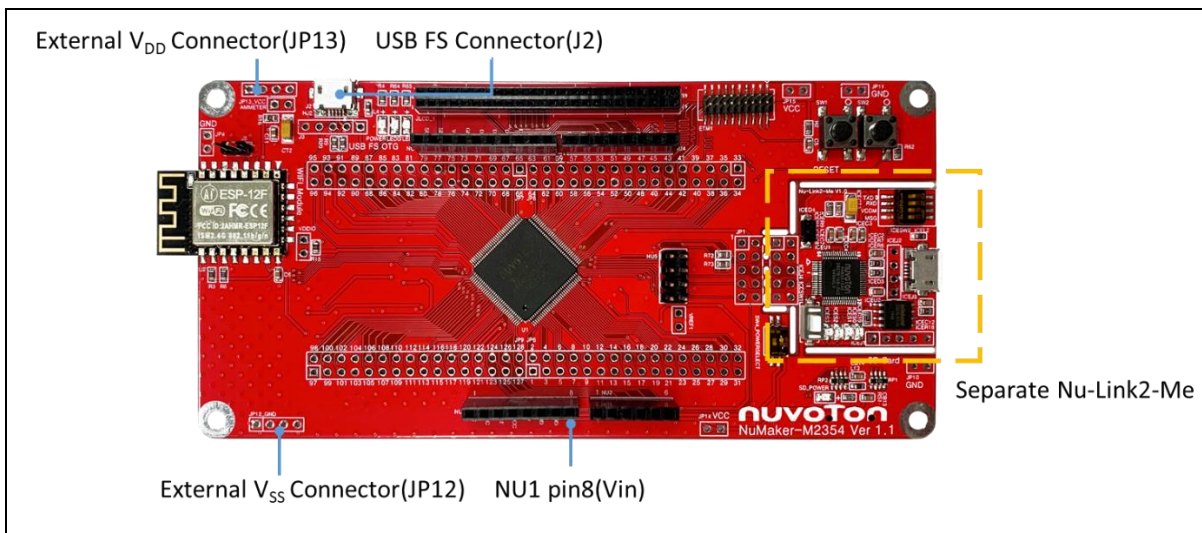

Figure 3-7 Separate the Nu-Link2-Me from NuMaker-M2354

Table 3-12 presents all power models when supplying external power through the M2354 target board. The M2354 target board external power sources are highlighted in yellow.

Model	Target Chip Voltage	Vin <sup>[1]</sup>	J2	ICEJ3	SW4 Selection	JP13	ICEJPR1 (MCUVCC) Selection <sup>[2]</sup>	ICEJPR2 (ICEVCC) Selection <sup>[3]</sup>	ICE Chip Voltage <sup>[4]</sup>
4	3.3 V	7 V ~ 12 V Input	-	-	SW4.2 ON	3.3 V output	Remove resistor	3.3 V	3.3 V
5	3.3 V	-	Connect to PC	-	SW4.2 ON	3.3 V output	Remove resistor	3.3 V	3.3 V
6	1.8 V ~ 3.6 V	- <sup>[5]</sup>	- <sup>[5]</sup>	Connect to PC	OFF	DC Input 1.8 V ~ 3.6 V	Remove resistor	1.8 V / 3.3 V	1.8 V / 3.3 V
7	1.8 V ~ 3.6 V	- <sup>[5]</sup>	- <sup>[5]</sup>	Nu-Link2-Me removed	OFF	DC Input 1.8 V ~ 3.6 V	-	-	-

-: Unused.

**Note:**

1. The Vin input voltage will be converted by voltage regulator UP2 to 5 V.
2. 0Ω should be removed from ICEJPR1's MCVCC and 1.8 V / 3.3 V / 5 V.
3. 0Ω should be soldered between ICEJPR2's ICEVCC and 1.8 V / 3.3 V.
4. The ICE chip voltage should be close to the target chip voltage.
5. JP13 external power input only provides voltage to the target chip. Supplying external power to Vin or J2 can provide 5V to NU1 pin5 (5V) and 3.3V to NU1 pin4 (3VCC).

Table 3-12 Supply External Power for M2354 target board

### 3.5 External Reference Voltage Connector

Table 3-14 presents the external reference voltage connector.

Connector	Comment
VREF1	VREF1 is used to easily connect to the external reference voltage pin of the target chip. Remove the L11 ferrite bead before using it.

Table 3-13 External Reference Voltage Connector

### 3.6 Ammeter Connector

Table 3-14 presents the ammeter connector.

Connector	Comment
AMMETER	AMMETER is used to easily measure the target chip power consumption. Remove the R16 resistor before using it.

Table 3-14 Ammeter Connector

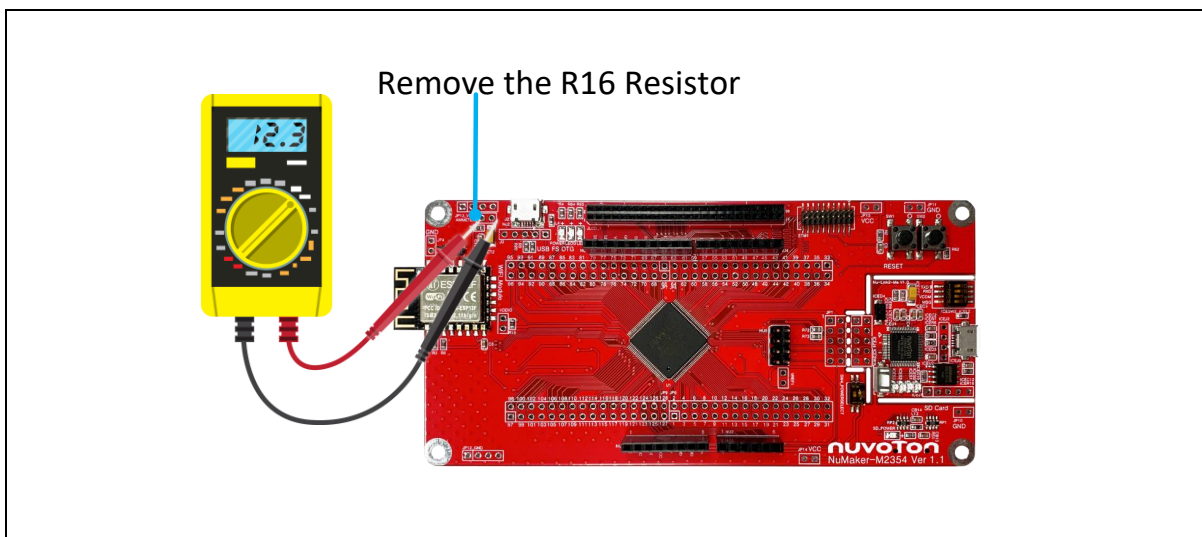

Figure 3-8 Wiring between Ammeter Connector and Ammeter

### 3.7 Push-Buttons

Table 3-15 presents the push-buttons.

Component	Comment
ICESW1	Off-line program button to start off-line programming the target chip.
SW1	Reset button to reset the target chip.
SW2	Push-Button to control application process.

Table 3-15 Push-Buttons

### 3.8 MicroSD Card Slot

U9: MicroSD card slot for application use.



### 3.9 SWD / ETM interface

The ETM is a debug interface that enables reconstruction of program execution. It provides instruction and data tracing of a processor. The traced data can be used to capture events leading to a breakpoint, or used for code coverage statistics or execution information.

**ETM1:** SWD / ETM interface connector with 20 pins on the NuMakerM2354 board.

### 3.10 LEDs

Table 3-16 presents the LEDs.

Component	Comment
Power LED	The power LED indicates that the NuMaker-M2354 is powered.
PD2, PD3 LED	The LED is connected to the target chip PD.2 and PD.3.
ICES0, ICES1, ICES2 and ICES3	Nu-Link2-Me status LED.

Table 3-16 LEDs

### 3.11 Wi-Fi Module (ESP-12)

**U10:** Wi-Fi Module ESP-12 on the NuMaker-M2354 board for application use.

NuMaker-M2354	ESP-12	Description
UART4_RXD	UTXD_ESP12	UART data out from ESP-12
UART4_TXD	URXD_ESP12	UART data in from ESP-12
UART4_nRTS	UCTS_ESP12	CTS pin for flow control
UART4_nCTS	URTS_ESP12	RTS pin for flow control
PD.12	IO0_ESP12	General Purpose Input/Output Interface
PC.13	RST_ESP12	General Purpose Input/Output Interface
J5	IO0_ESP12	For Wi-Fi updated

Table 3-17 Optional Function of ESP-12

### 3.12 HTN-LCD Panel

The NuMaker-M2354 equip with a COM/SEG LCD interface which can connect to LCD panel.

**JLCD\_1:** 8 COM / 40 SEG LCD connective interface.

**JLCD\_2:** LCD Panel (HTN-3.3V)

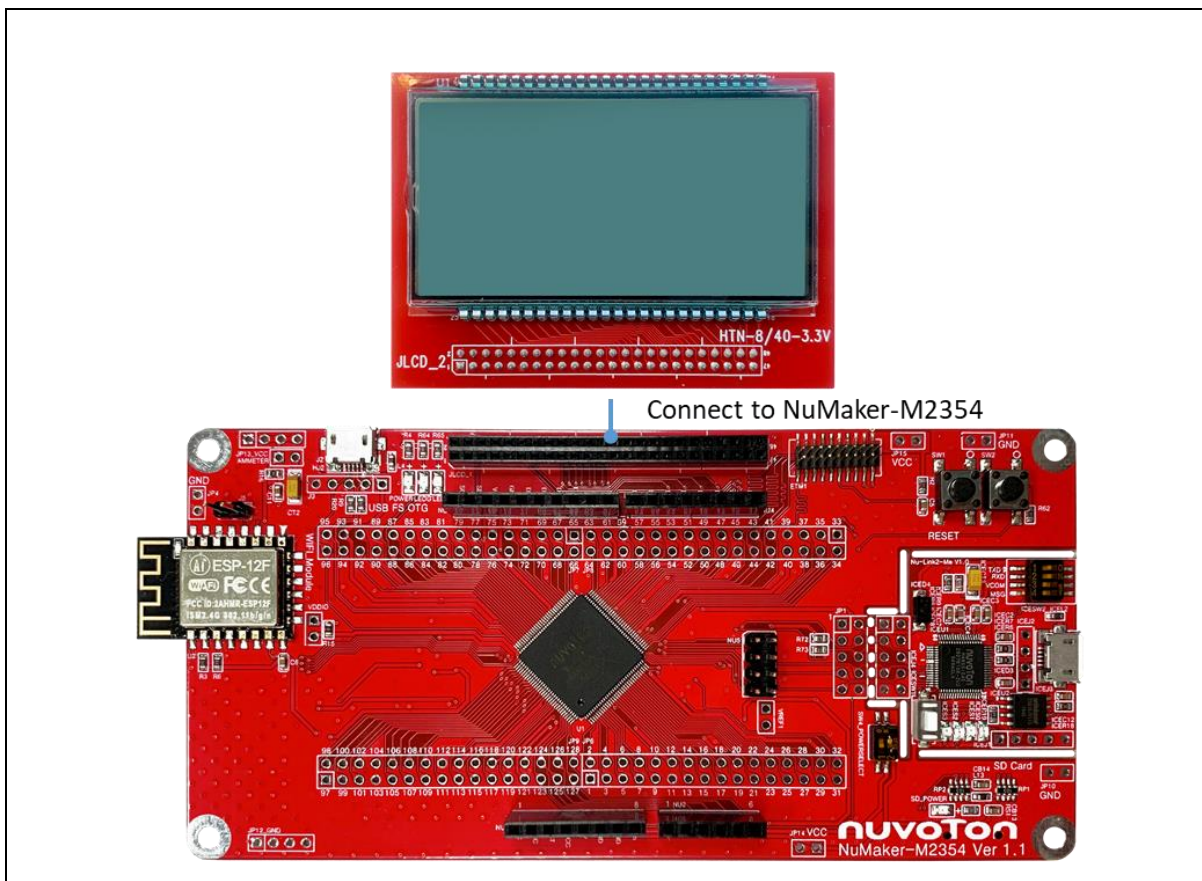

Figure 3-9 LCD interface

### 3.13 Nu-Link2-Me

The Nu-Link2-Me is an attached on-board debugger and programmer. The Nu-Link2-Me supports on-chip debugging, online and off-line ICP programming through SWD interface. The Nu-Link2-Me also supports virtual COM port (VCOM) for printing debug messages on PC. Besides, the programming status can be shown on the built-in LEDs. Lastly, the Nu-Link2-Me can be detached from the evaluation board and becoming a stand-alone mass production programmer. For more information about Nu-Link2-Me, please refer to *Nu-Link2-Pro Debugger and Programmer User Manual*.

#### 3.13.1 VCOM Switches

Table 3-18 presents how to set the VCOM function by ICESW2.

ICESW2		
Pin	Function	Description
1	TXD	<b>On:</b> Connect target chip PA.7 (UART0_TXD) to Nu-Link2-Me. <b>Off:</b> Disconnect target chip PA.7 (UART0_TXD) to Nu-Link2-Me.
2	RXD	<b>On:</b> Connect target chip PA.6 (UART0_RXD) to Nu-Link2-Me. <b>Off:</b> Disconnect target chip PA.6 (UART0_RXD) to Nu-Link2-Me.
<b>Note:</b> Pin 3 and 4 is unused.		

Table 3-18 VCOM Function of Nu-Link2-Me

#### 3.13.2 Status LEDs

Table 3-19 presents the status LEDs patterns for different operation on Nu-Link2-Me.

Operation Status	Status LED			
	ICES0	ICES1	ICES2	ICES3
Power on	Flash x 3	Flash x 3	Flash x 3	Flash x 3
Connected to IDE/NuTool	Flash x 3	Flash x 3	Flash x 3	On
ICE online (Not connected to a target chip)	On	-	Flash x 3	Flash x 3
ICE online (Connected to a target chip)	On	-	-	On
ICE online (Failed to connect to a target chip)	On	Any	Flash	On
During Off-line Programming	-	On	-	Flash
Off-line Programming Completed	On	-	-	-
Off-line Programming Completed (Auto mode)	On	On	-	-
Off-line Programming Failed	On	Flash	-	-

Table 3-19 Status LEDs patterns of Nu-Link2-Me

## 4 QUICK START

### 4.1 Toolchains Support

Install the preferred toolchain. Please make sure at least one of the toolchains has been installed.

- [KEIL MDK Nuvoton edition M0/M23](#)
- [IAR EWARM](#)
- [NuEclipse \(GCC\)\(Windows\)](#)
- [NuEclipse \(GCC\)\(Linux\)](#)

### 4.2 Nuvoton Nu-Link Driver Installation

Download and install the latest Nuvoton Nu-Link Driver.

- Download and install [Nu-Link\\_Keil\\_Driver](#) when using Keil MDK.
- Download and install [Nu-Link\\_IAR\\_Driver](#) when using IAR EWARM.
- Skip this step when using NuEclipse.

Please install the Nu-Link USB Driver as well at the end of the installation. The installation is presented in Figure 4-1 and Figure 4-2.

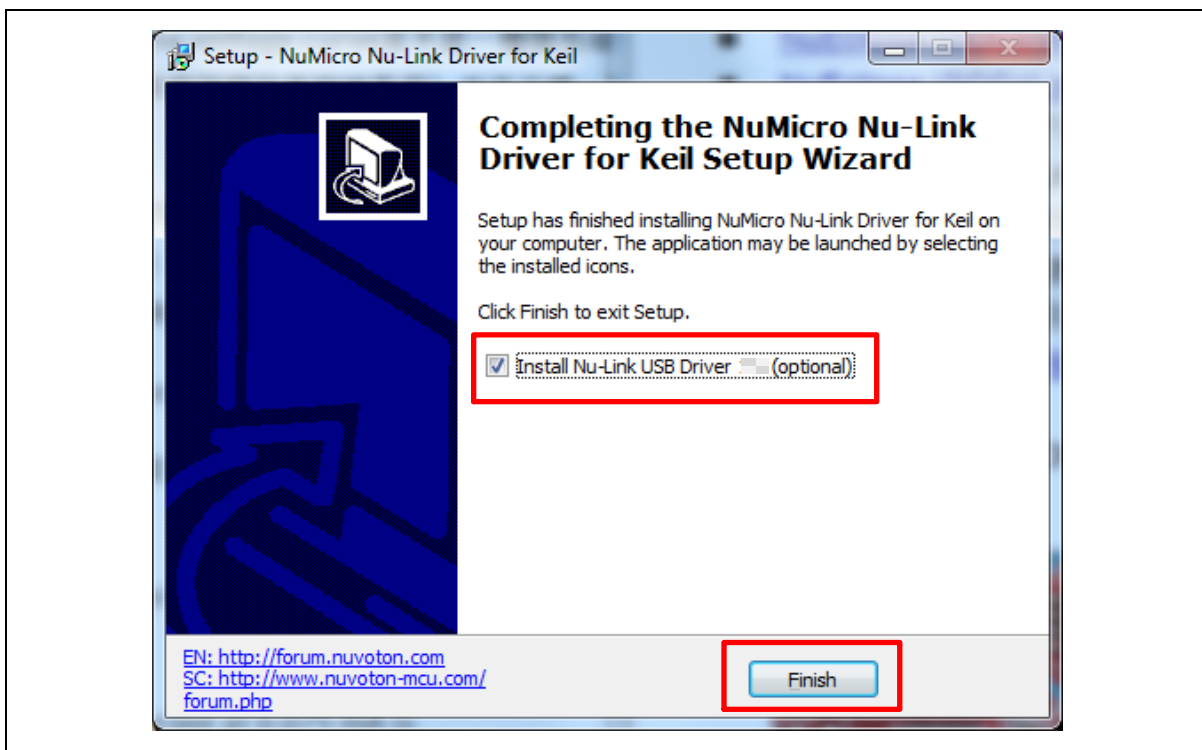

Figure 4-1 Nu-Link USB Driver Installation Setup



Figure 4-2 Nu-Link USB Driver Installation



### 4.3 BSP Firmware Download

Download and unzip the [Board Support Package \(BSP\)](#).

### 4.4 Hardware Setup

1. Open the virtual COM (VCOM) function by changing Nu-Link2-Me VCOM Switch No. 1 and 2 to ON.

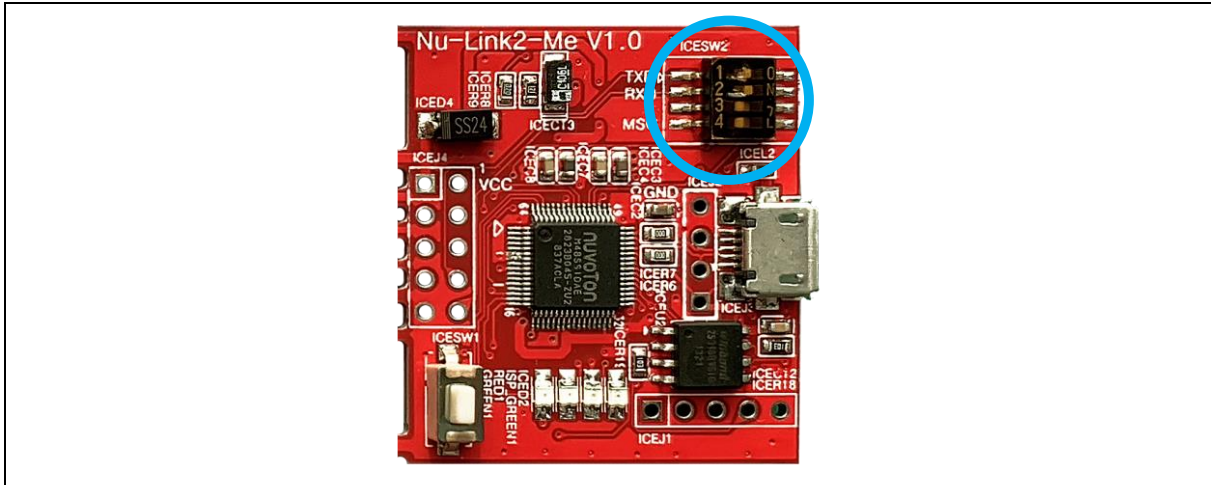

Figure 4-3 Open VCOM Function

2. Connect the ICE USB connector shown in Figure 4-4 to the PC USB port through a USB cable.

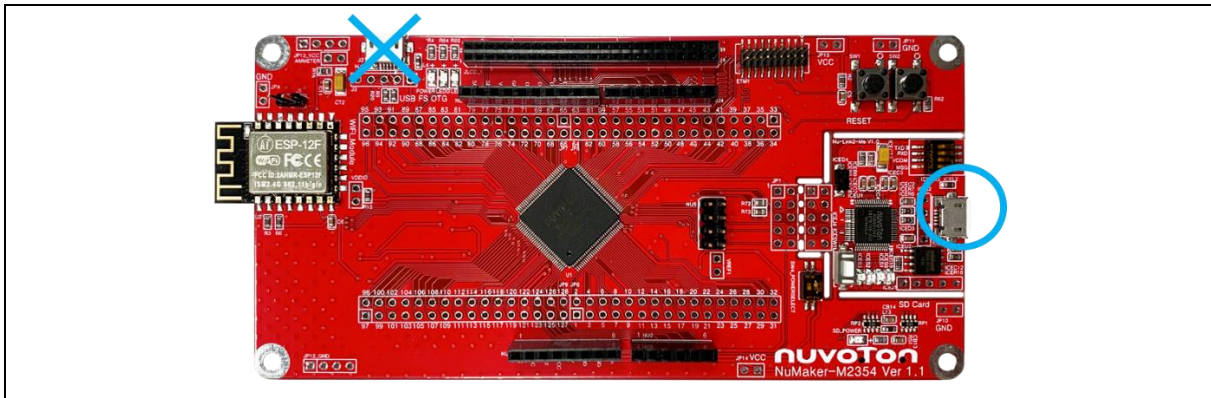

Figure 4-4 ICE USB Connector

3. Find the “Nu-Link2 Virtual Com Port” on the Device Manger as Figure 4-5.

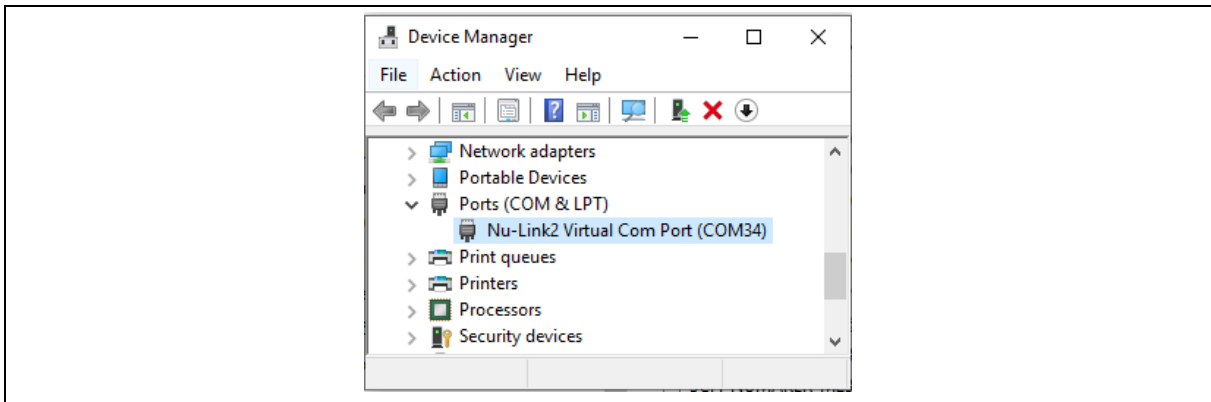

Figure 4-5 Device Manger

- 4. Open a serial port terminal, PuTTY for example, to print out debug message. Set the speed to 115200. Figure 4-6 presents the PuTTY session setting.

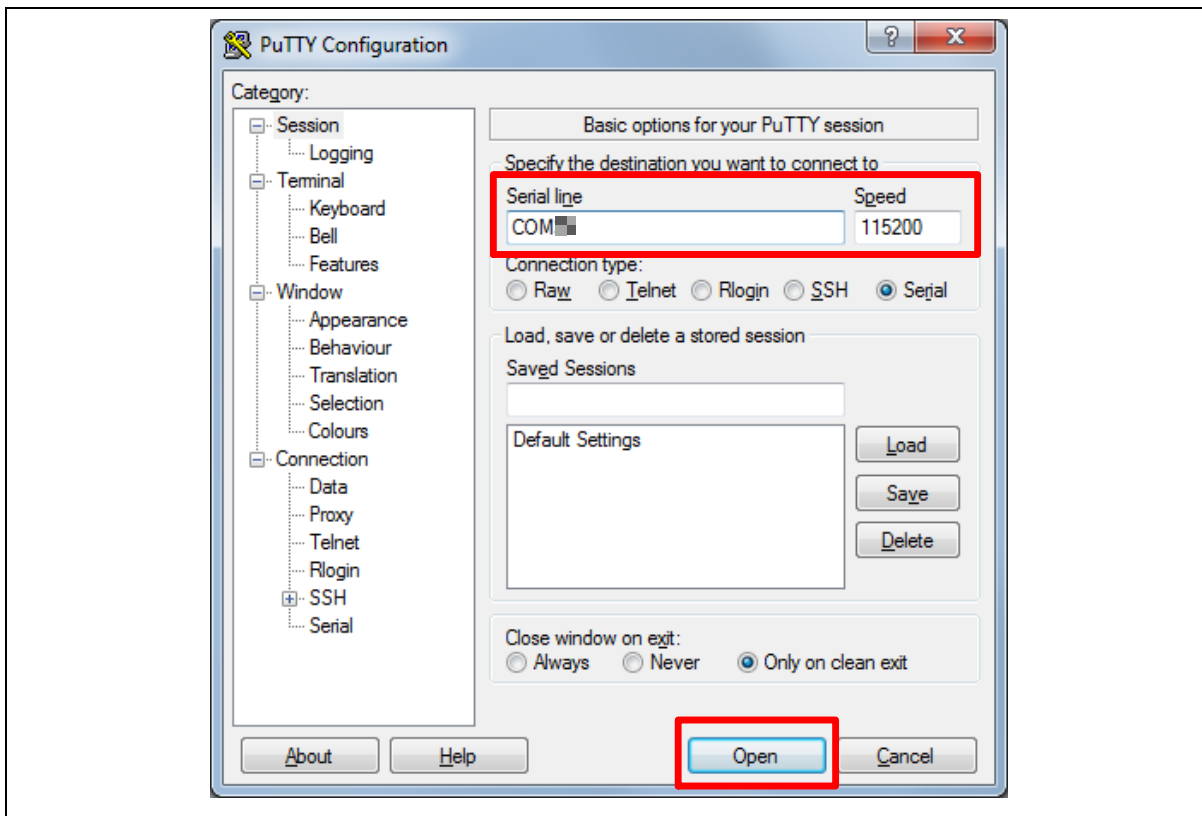

Figure 4-6 PuTTY Session Setting

### 4.5 Finding the Example Project

Use the “Blinky” project as an example. The project can be found under the BSP folder as shown in Figure 4-7.

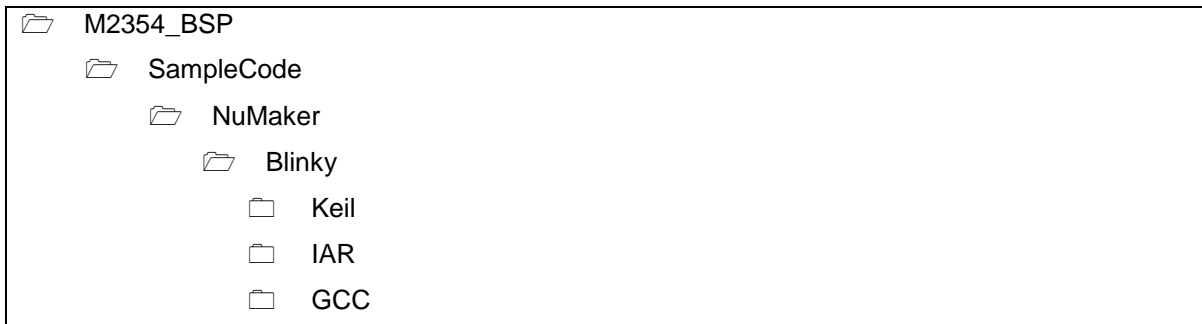

Figure 4-7 Blinky Project Folder Path

### 4.6 Executing the Project under Toolchains

Open and execute the project under the toolchain. The section 4.6.1, 4.6.2, and 4.6.3 describe the steps of executing project in Keil MDK, IAR EWARM and NuEclipse, respectively.

#### 4.6.1 Keil MDK

This section provides steps to beginners on how to run a project by using Keil MDK.

1. Double click the “Blinky.uvprojx” to open the project.
2. Make sure the debugger is “Nuvoton Nu-Link Debugger” as shown in Figure 4-8 and Figure 4-9.

**Note:** If the dropdown menu in Figure 4-8 does not contain “Nuvoton Nu-Link Debugger” item, please rework section 4.2.

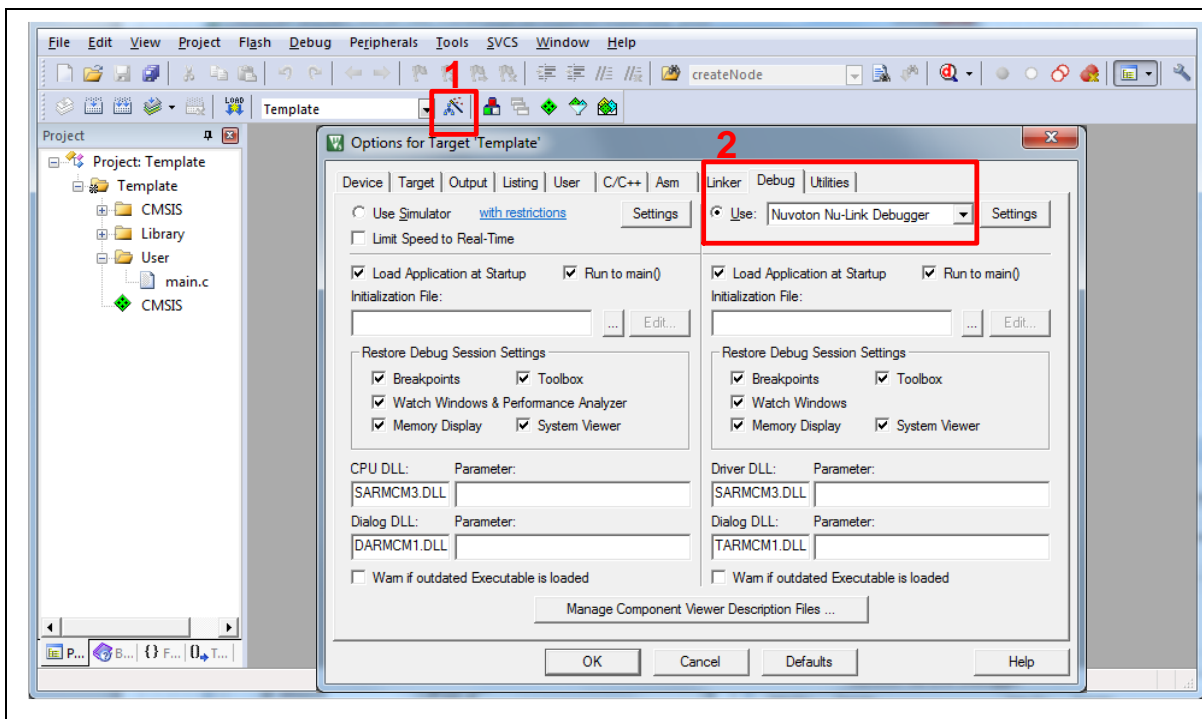

Figure 4-8 Debugger Setting in Options Window



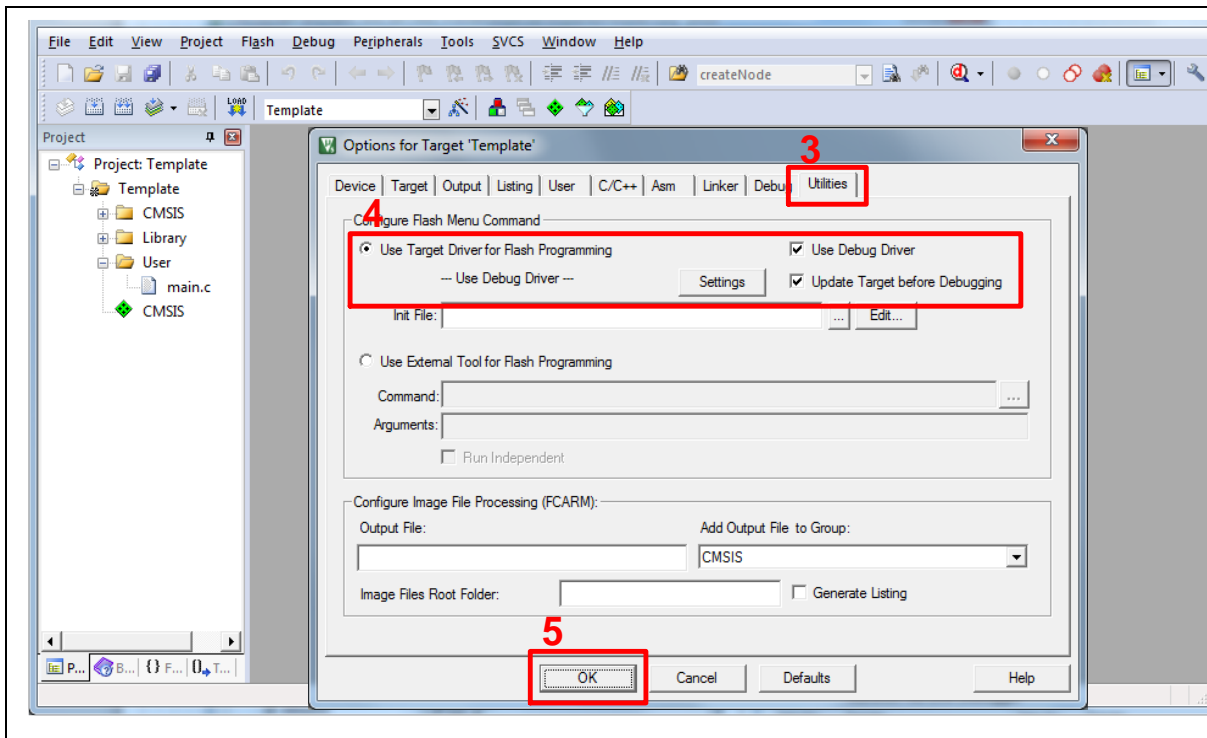

Figure 4-9 Programming Setting in Options Window

3. Rebuild all target files. After successfully compiling the project, download code to the Flash memory. Click **"Start/Stop Debug Section"** icon to enter debug mode.

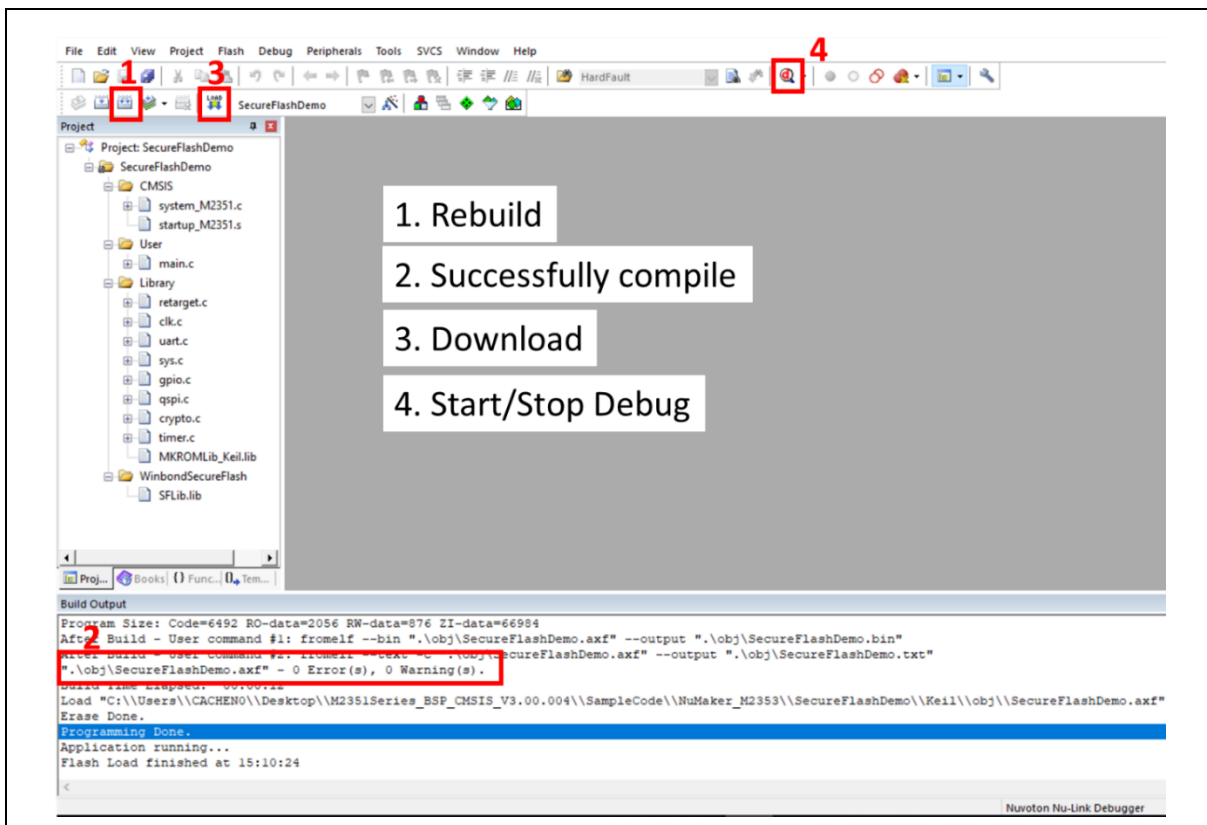

Figure 4-10 Compile and Download the Project

- Figure 4-11 shows the debug mode under Keil MDK. Click “Run” and the debug message will be printed out as shown in Figure 4-12. User can debug the project under debug mode by checking source code, assembly language, peripherals’ registers, and setting breakpoint, step run, value monitor, etc.

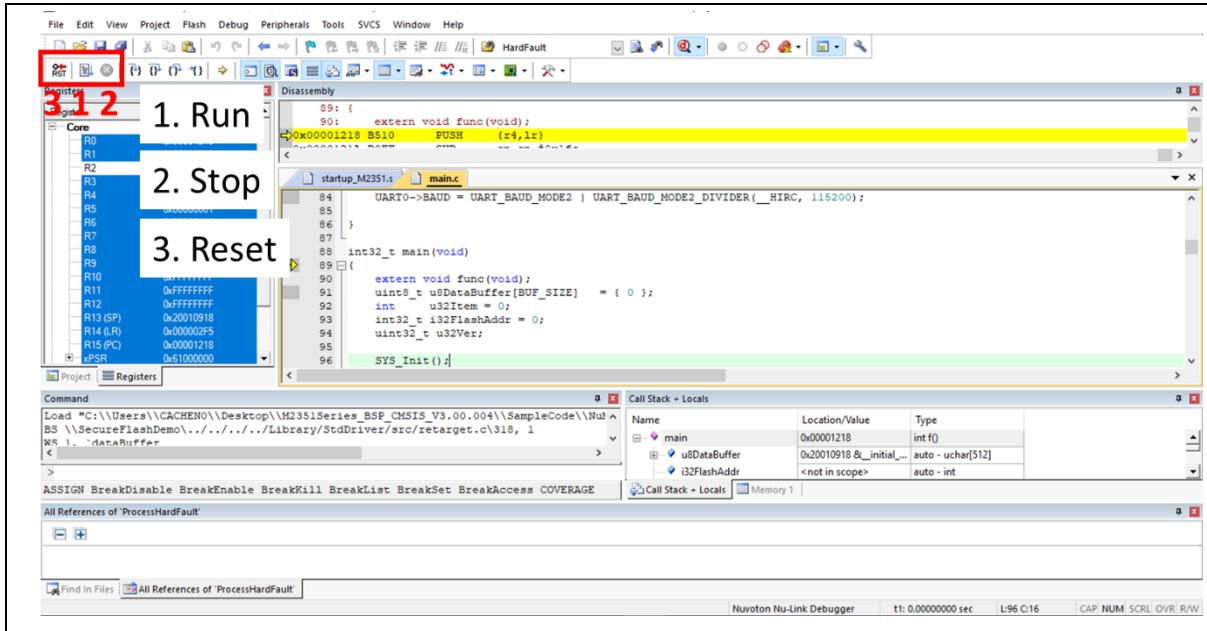

Figure 4-11 Keil MDK Debug Mode

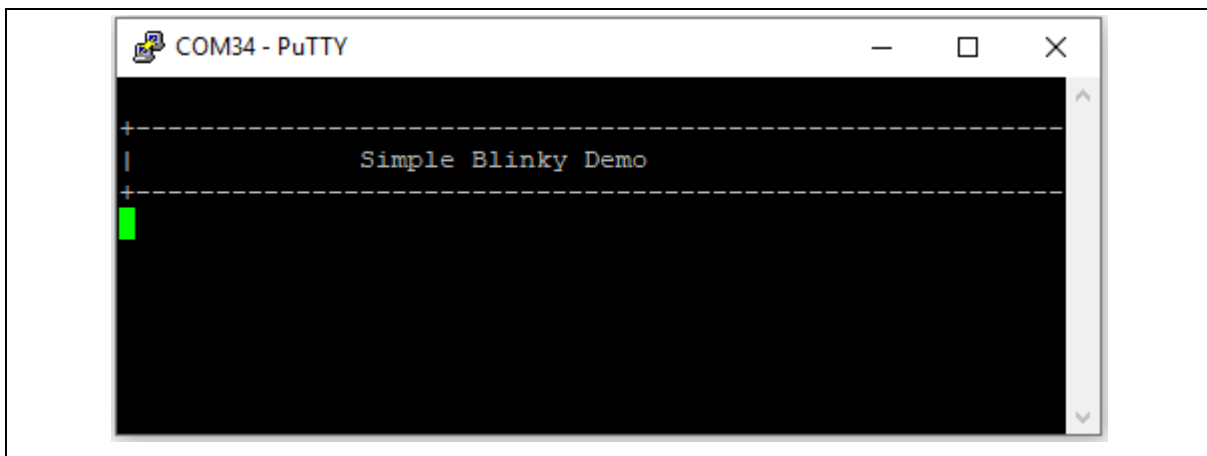

Figure 4-12 Debug Message on Serial Port Terminal Windows

### 4.6.2 IAR EWARM

This section provides steps to beginners on how to run a project by using IAR EWARM.

1. Double click the “Blinky.eww” to open the project.
2. Make sure the toolbar contain “Nu-Link” item as shown in Figure 4-13.

**Note:** If the toolbar does not contain “Nu-Link” item, please rework section 4.2.

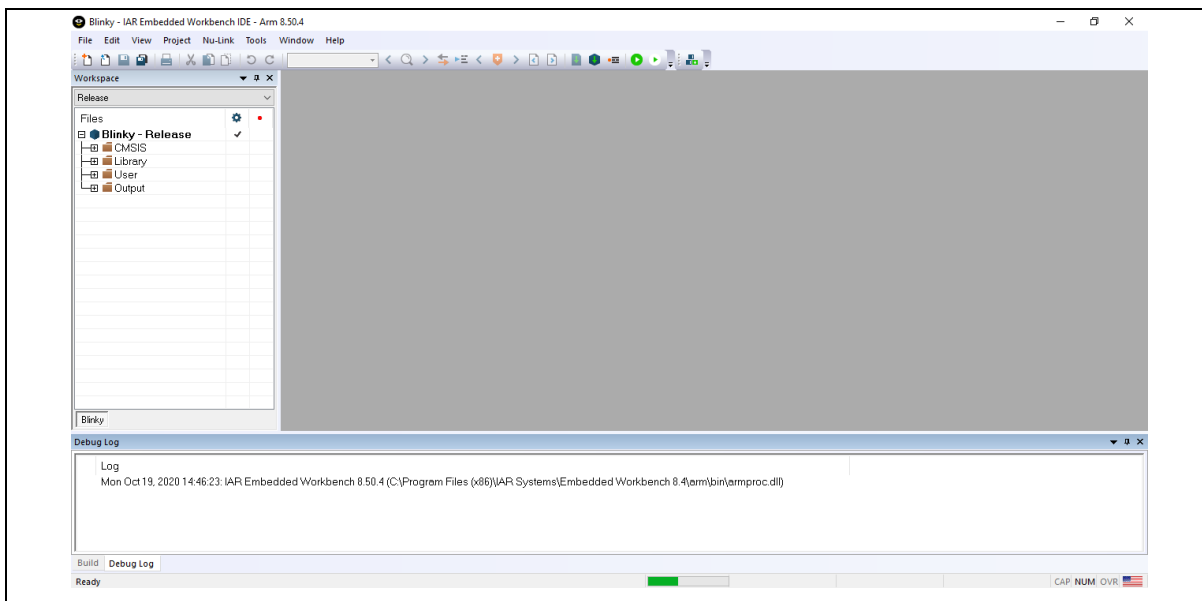

Figure 4-13 IAR EWARM Window

3. Make target file as presented in Figure 4-14. After successfully compile the project, download code to the flash memory and enter debug mode.

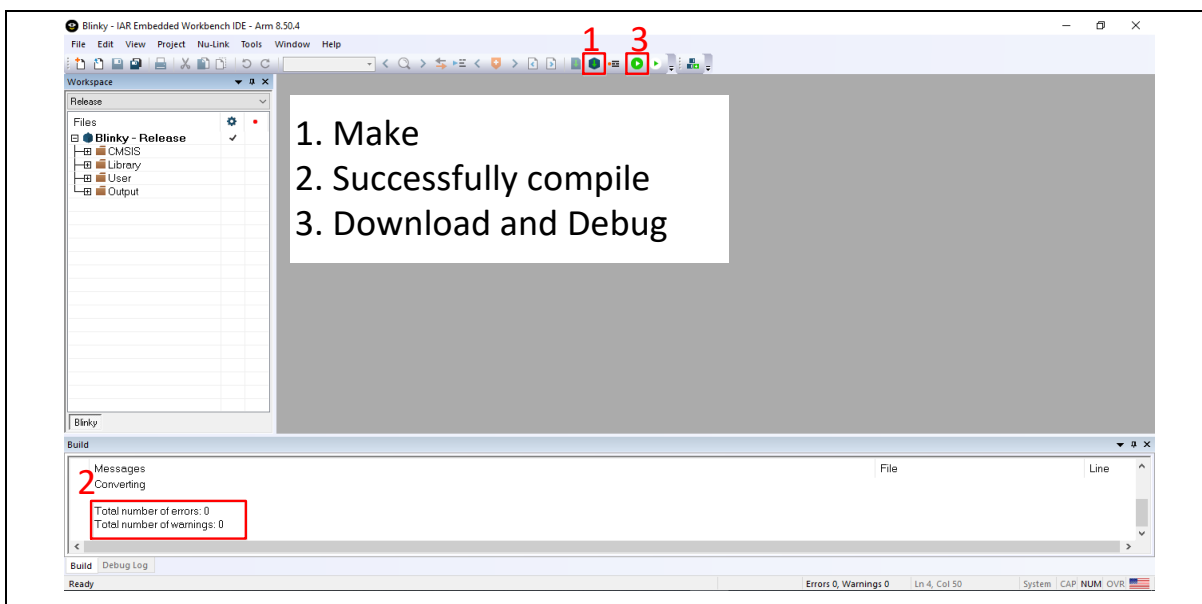

Figure 4-14 Compile and Download the Project

- Figure 4-15 shows the debug mode under IAR EWARN. Click “Go” and the debug message will be printed out as shown in Figure 4-16. The project can be debugged under debug mode by checking source code, assembly language, peripherals’ registers, and setting breakpoint, step run, value monitor, etc.

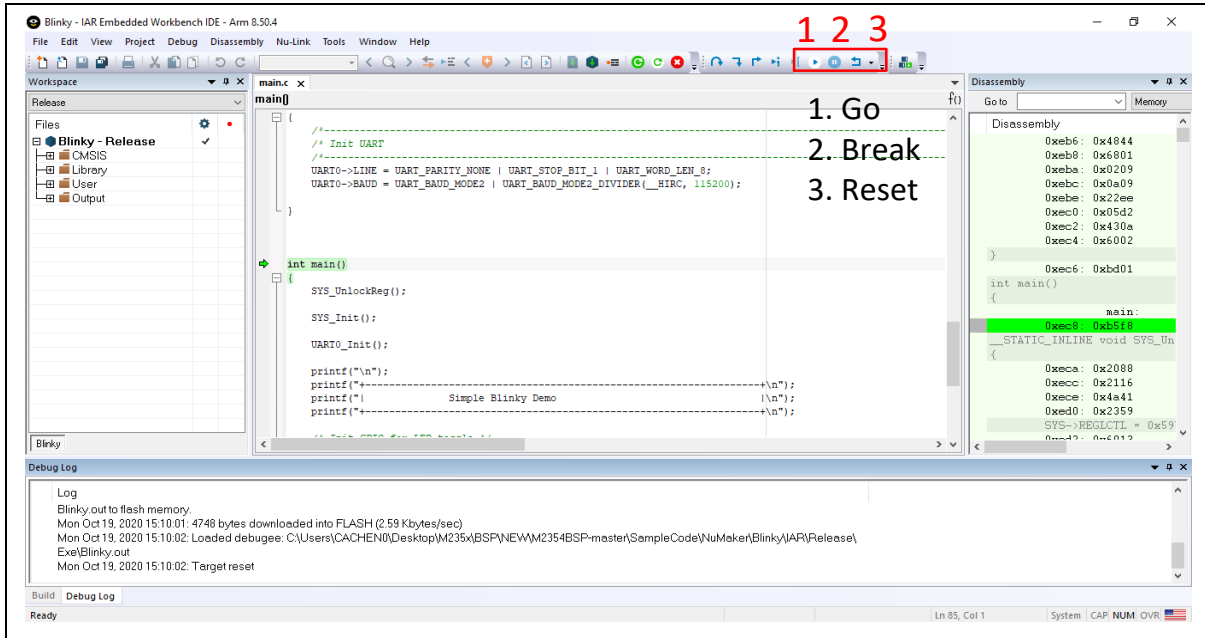

Figure 4-15 IAR EWARM Debug Mode

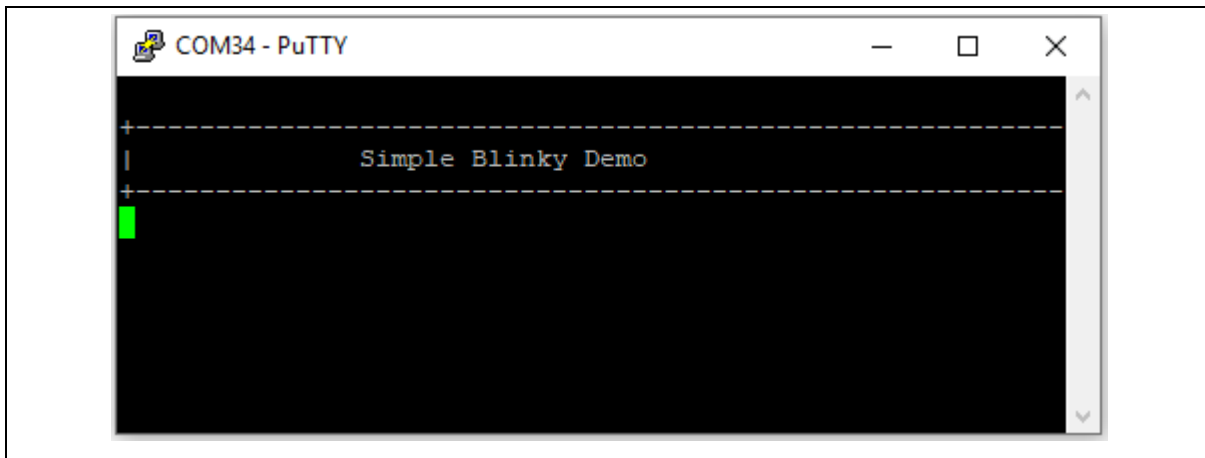

Figure 4-16 Debug Message on Serial Port Terminal Windows

### 4.6.3 NuEclipse

This section provides steps to beginners on how to run a project by using NuEclipse. Please make sure the filenames and project folder path contain neither invalid character nor space.

1. Double-click NuEclipse.exe to open the toolchain.
2. Import the “Blinky” project by following the steps presented in Figure 4-17 and Figure 4-18.

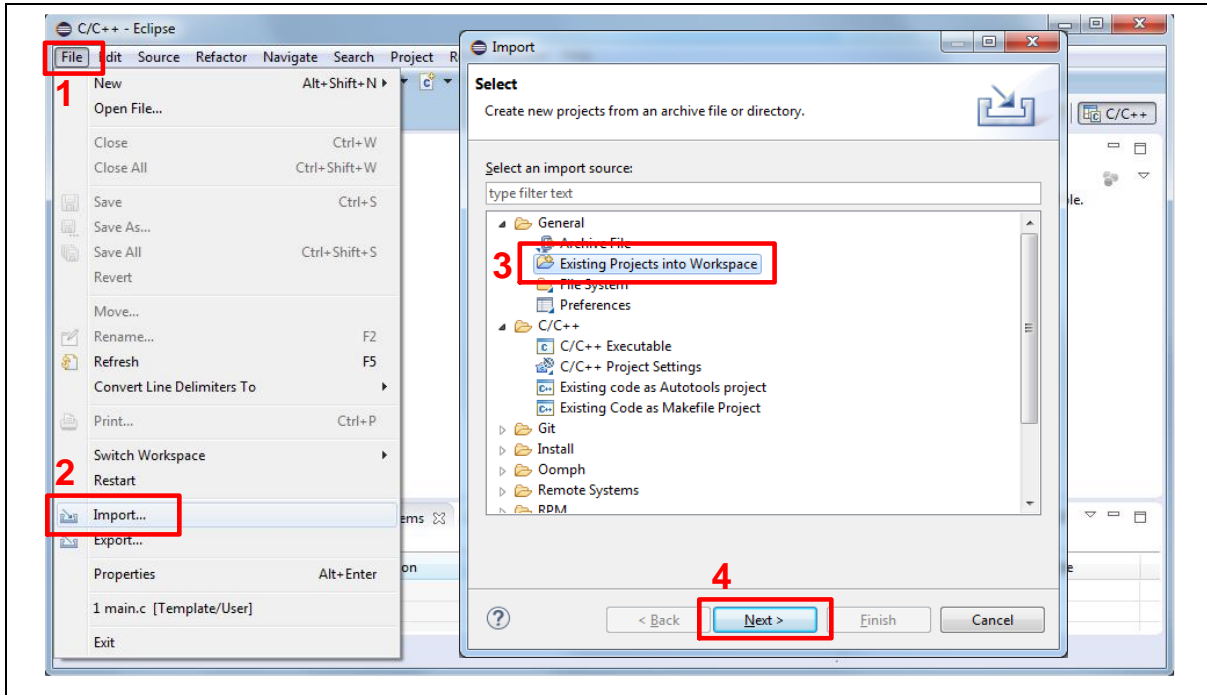

Figure 4-17 Import the Project in NuEclipse

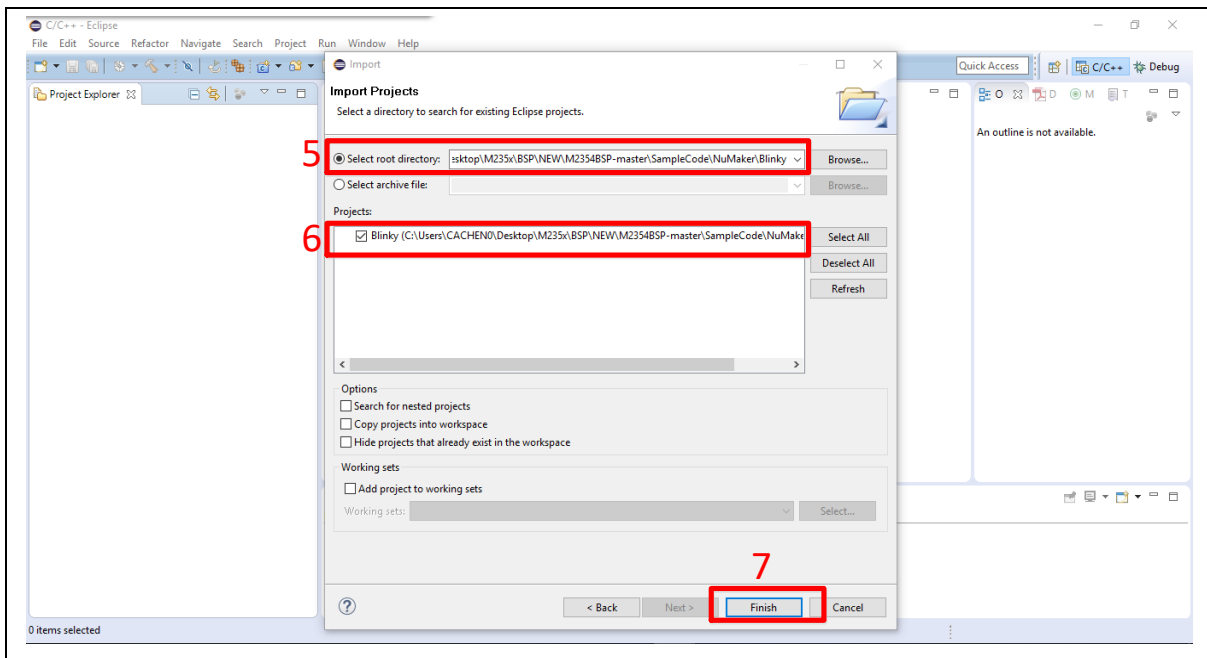

Figure 4-18 Import Projects Windows

3. Click the “Blinky” project and find the project properties as shown in Figure 4-19. Make sure the

settings are the same as settings in Figure 4-20.

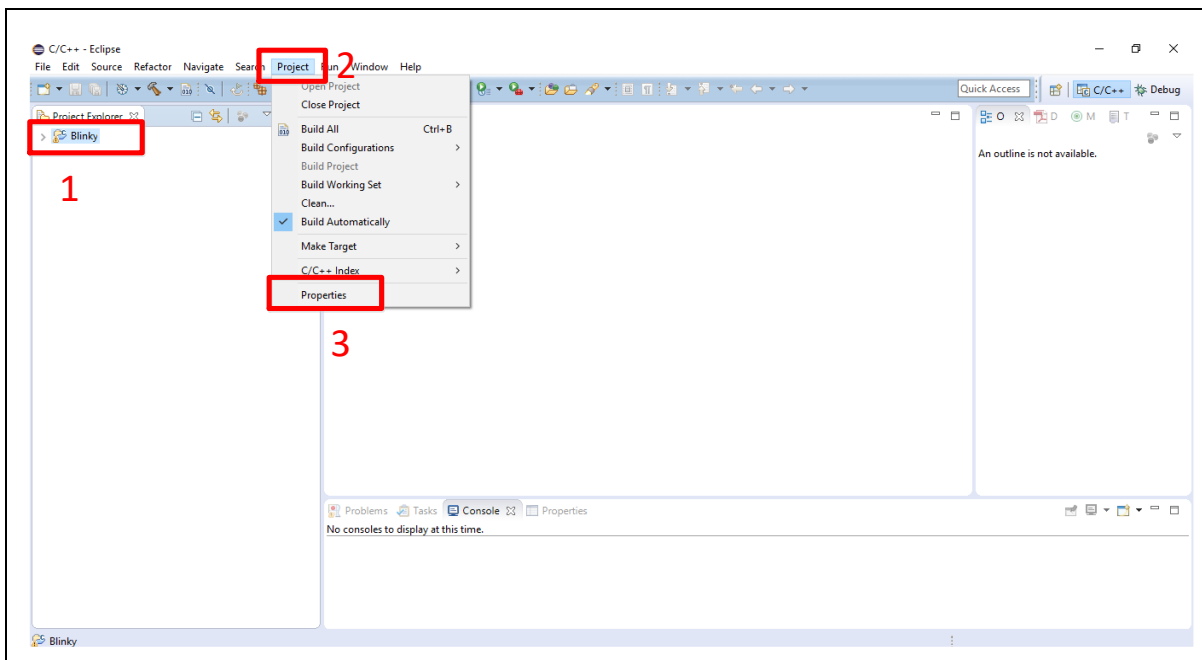

Figure 4-19 Build Project

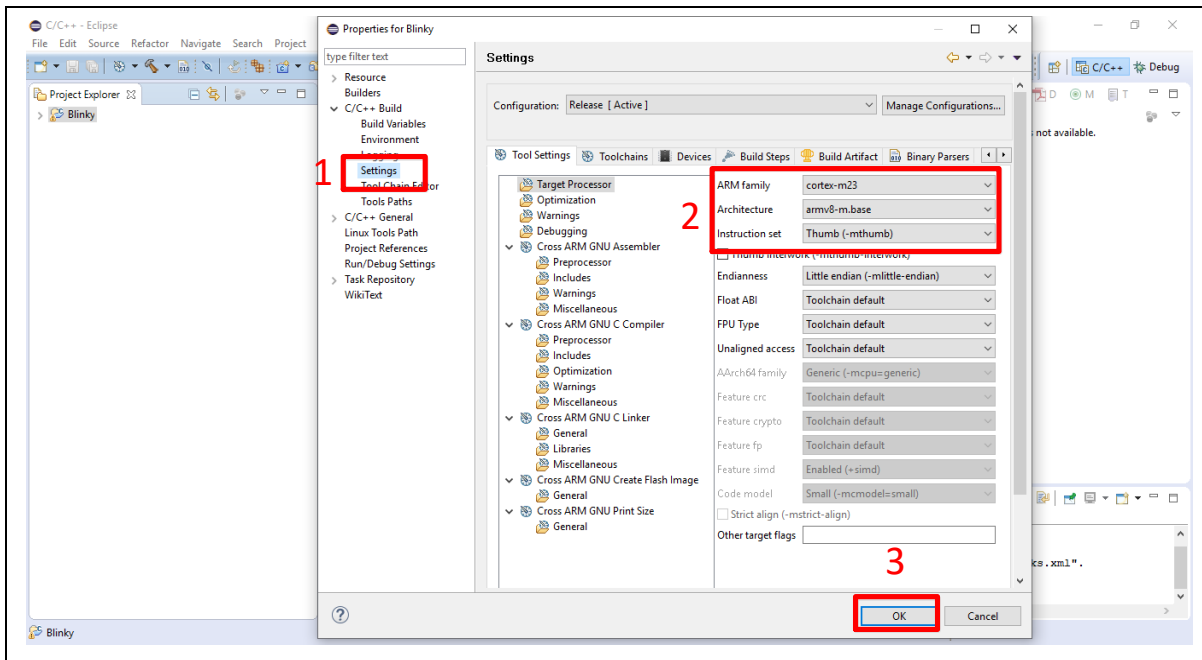

Figure 4-20 Project Properties Settings

4. Click the “Blinky” project and build the project.

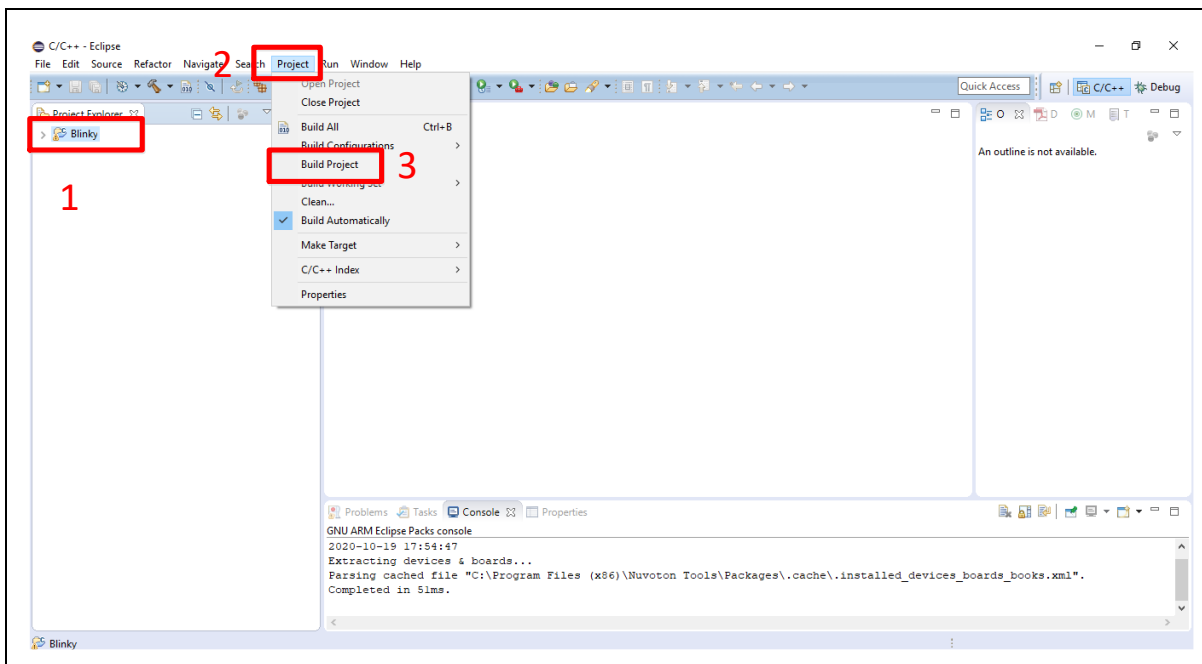

Figure 4-21 Build Project

- After the project is built, click the “Blinky” project and set the “Debug Configuration” as shown in Figure 4-22. Follow the settings presented in Figure 4-23, Figure 4-24 and Figure 4-25 to enter debug mode.

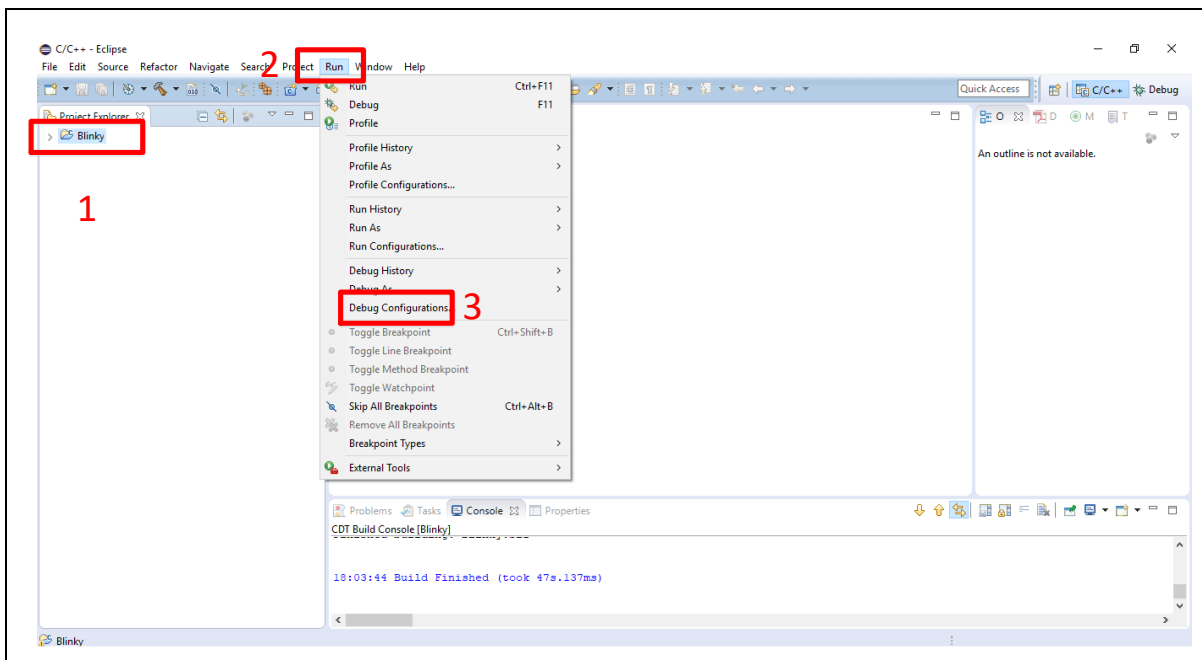
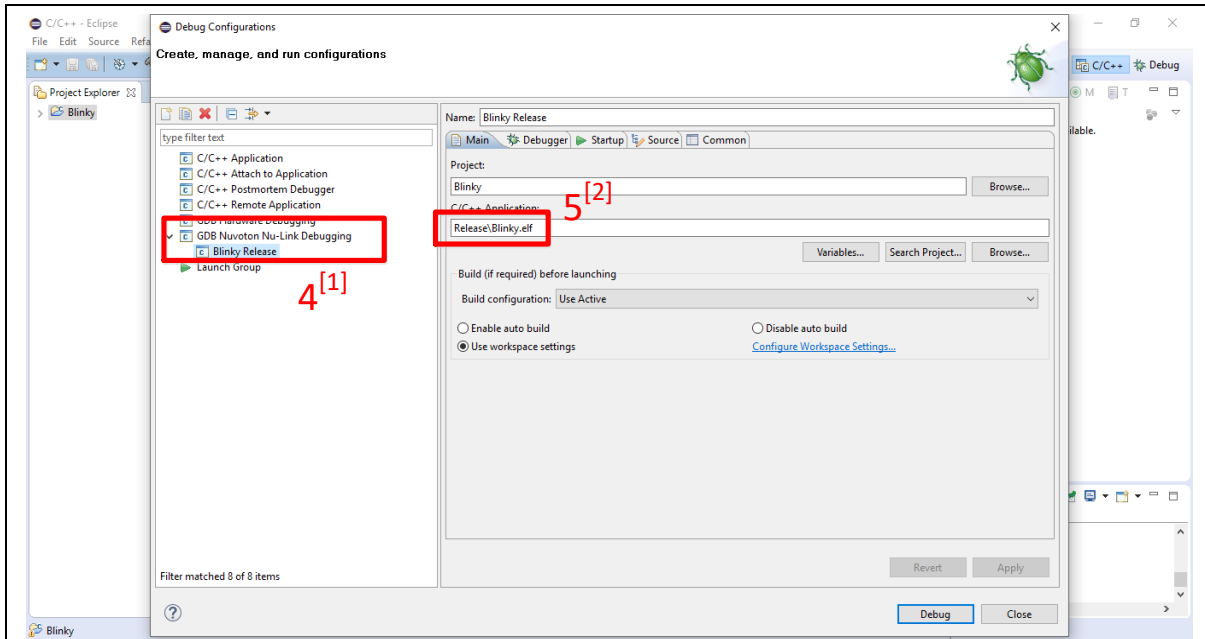

Figure 4-22 Open Debug Configuration



**Note 1:** Double click the “GDB Nuvoton Nu-Link Debugging” to create the subitem.

**Note 2:** After the project is built, the “\*.elf” file will be shown in “C/C++ Application” frame.

Figure 4-23 Main Tab Configuration

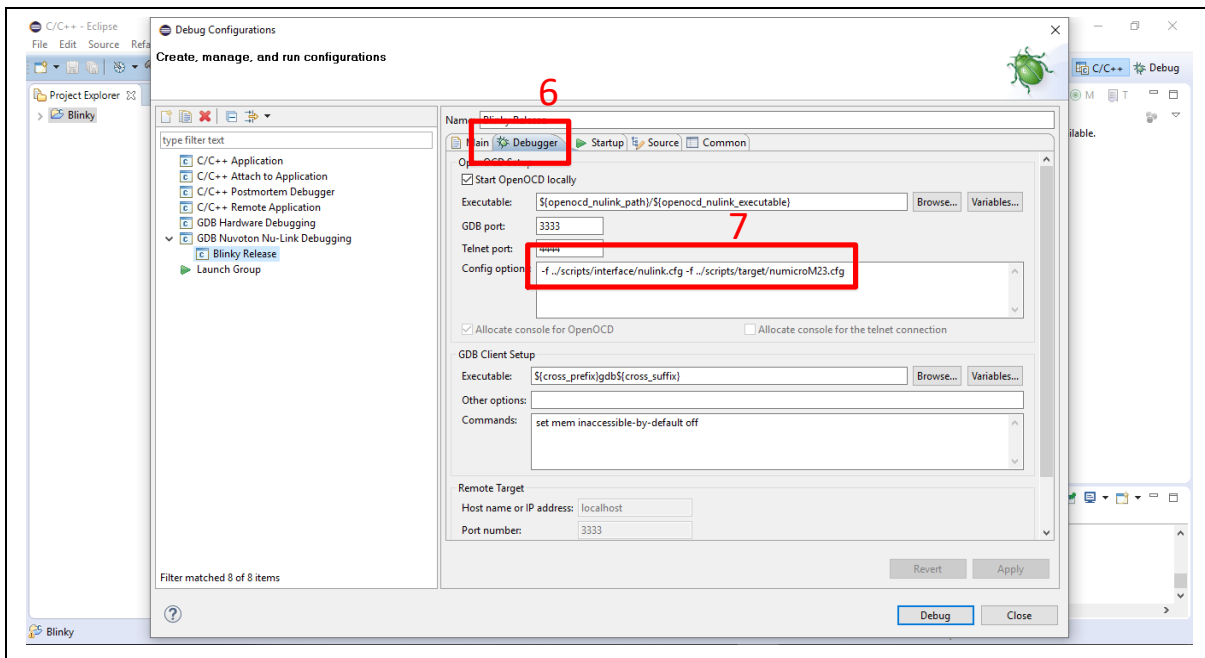

Figure 4-24 Debugger Tab Configuration



**Note 1:** Please follow the settings highlighted in green triangles and configure other settings depending on the needs.

Figure 4-25 Startup Tab Configuration

- Figure 4-26 shows the debug mode under NuEclipse. Click **Resume** and the debug message will be printed out as shown in Figure 4-27. User can debug the project under debug mode by checking source code, assembly language, peripherals' registers, and setting breakpoint, step run, value monitor, etc. For more information about how to use NuEclipse, please refer to the NuEclipse User Manual.

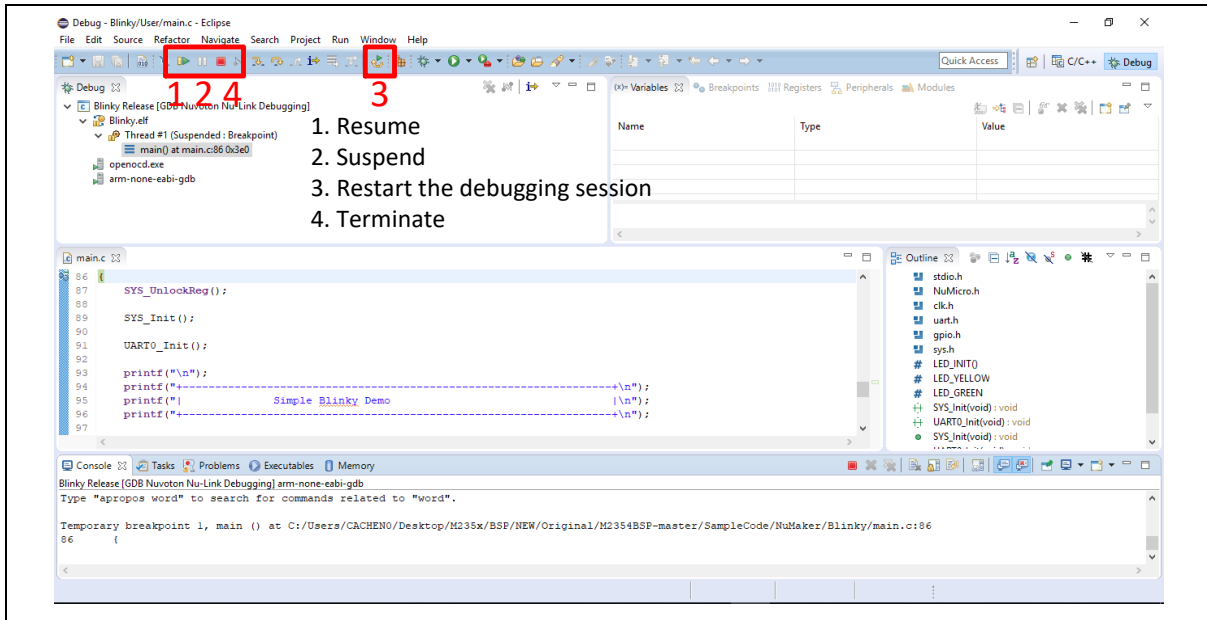

Figure 4-26 NuEclipse Debug Mode

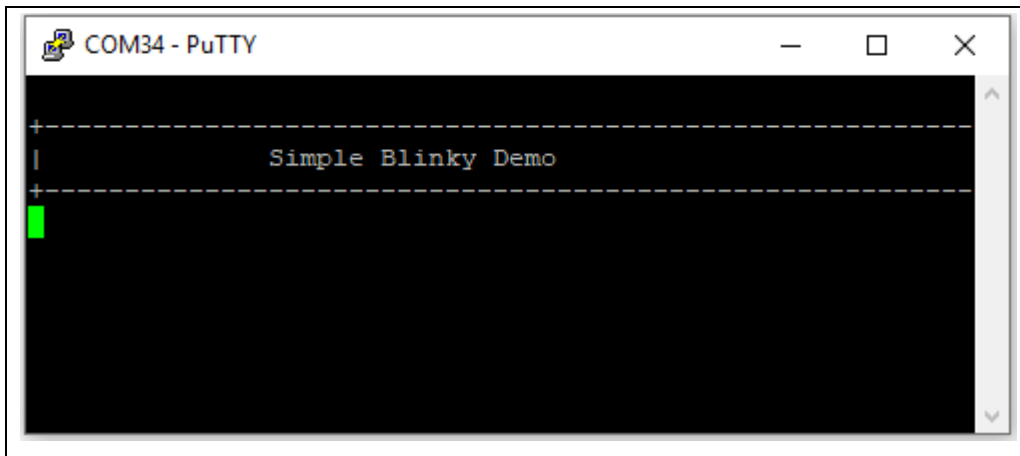
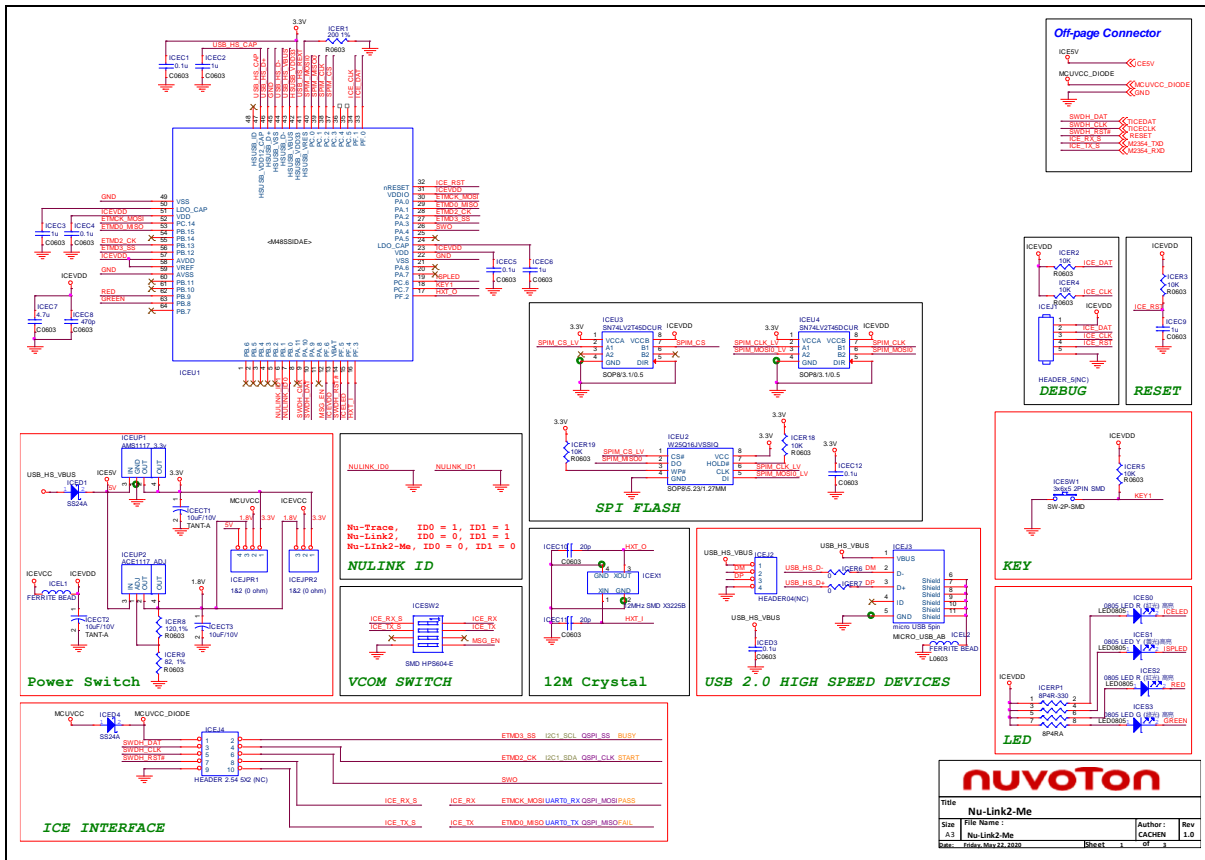

Figure 4-27 Debug Message on Serial Port Terminal Windows

## 5 NUMAKER-M2354 SCHEMATICS

### 5.1 Nu-Link2-Me

Figure 5-1 shows the Nu-Link2-Me circuit. The Nu-Link2-Me is a debugger and programmer that supports on-line programming and debugging through a SWD interface.



## 5.2 M2354 target Board

Figure 5-2 shows the pin assignment of the M2354.

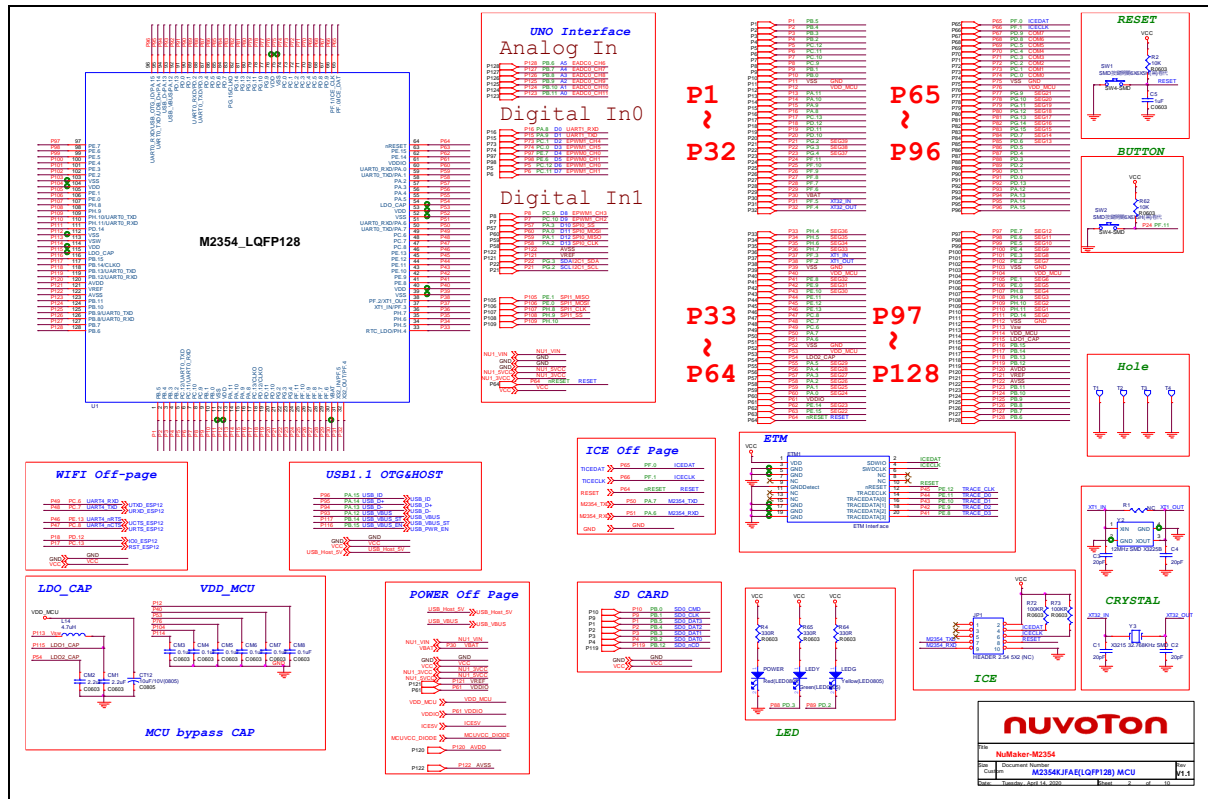

Figure 5-2 M2354 Pin Assignment

### 5.3 USB 2.0 FS OTG

Figure 5-3 shows the USB 2.0 FS OTG circuit on the NuMaker-M2354 board.

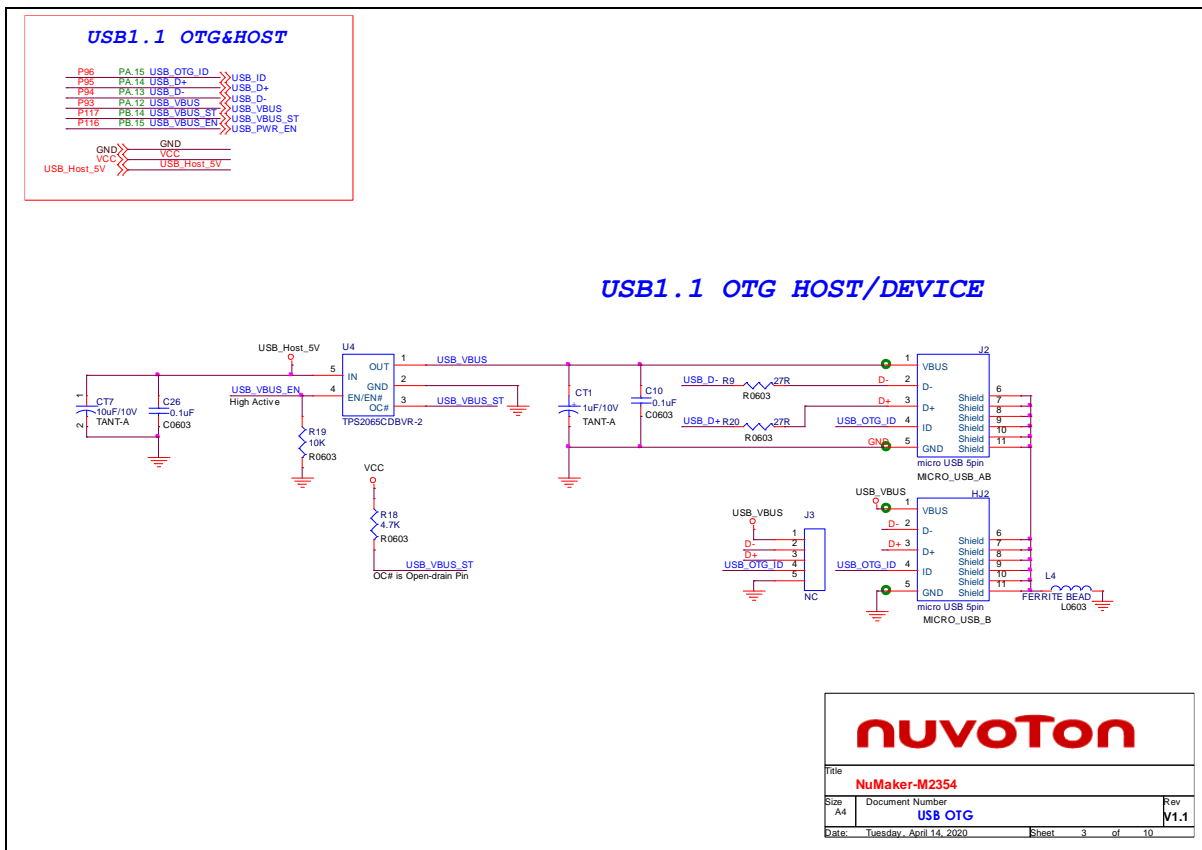

Figure 5-3 USB 2.0 FS OTG Circuit

### 5.4 Power Supply

Figure 5-4 shows power configurations of NuMaker-M2354 board.

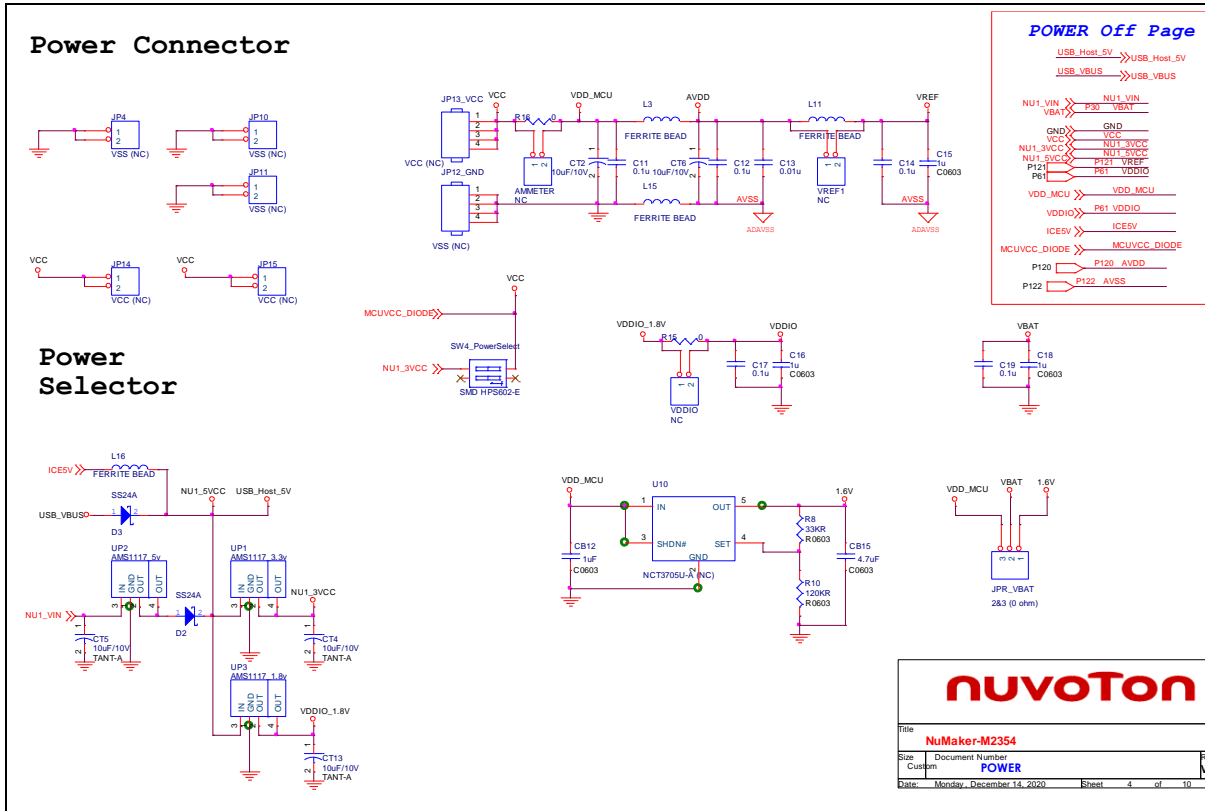

Figure 5-4 Power Circuit and Configurations



5.5 MCU Connector

Figure 5-5 shows the MCU Connector of JP6 to JP9.

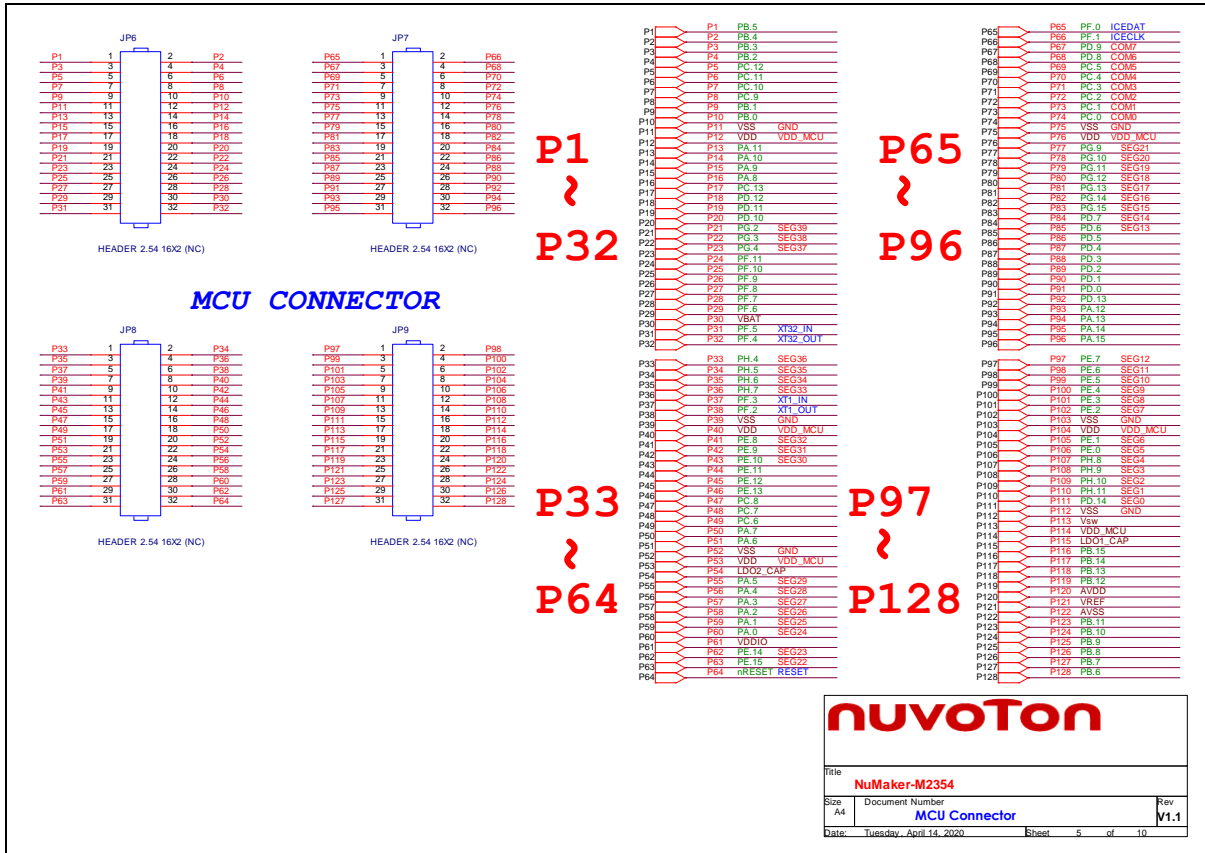

Figure 5-5 MCU connector

### 5.6 Arduino UNO Compatible Interface

Figure 5-6 shows the Arduino UNO compatible interface of NU1 to NU5 connectors.

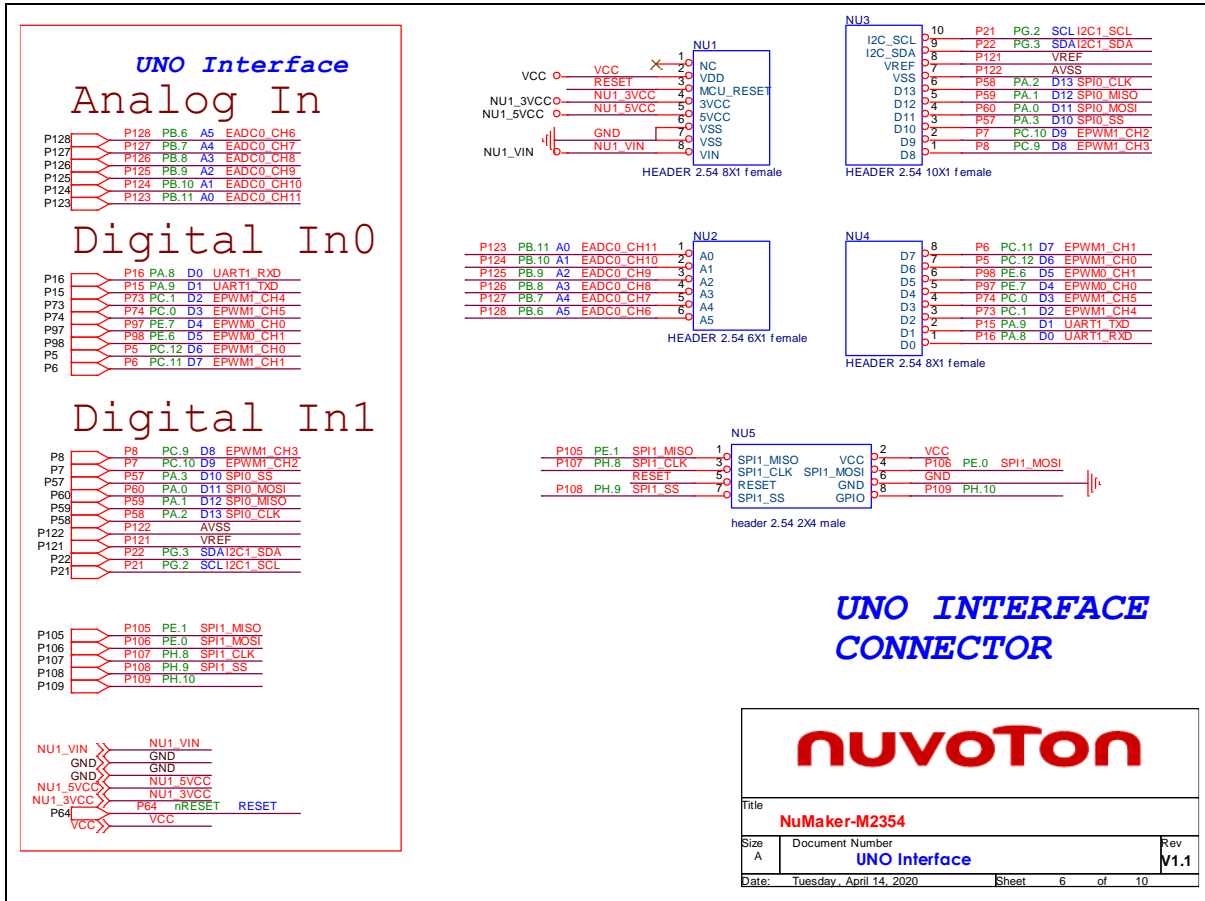

Figure 5-6 Arduino UNO Compatible Interface

### 5.7 MicroSD Card

Figure 5-7 shows the MicroSD Card circuit on the NuMaker-M2354 board.

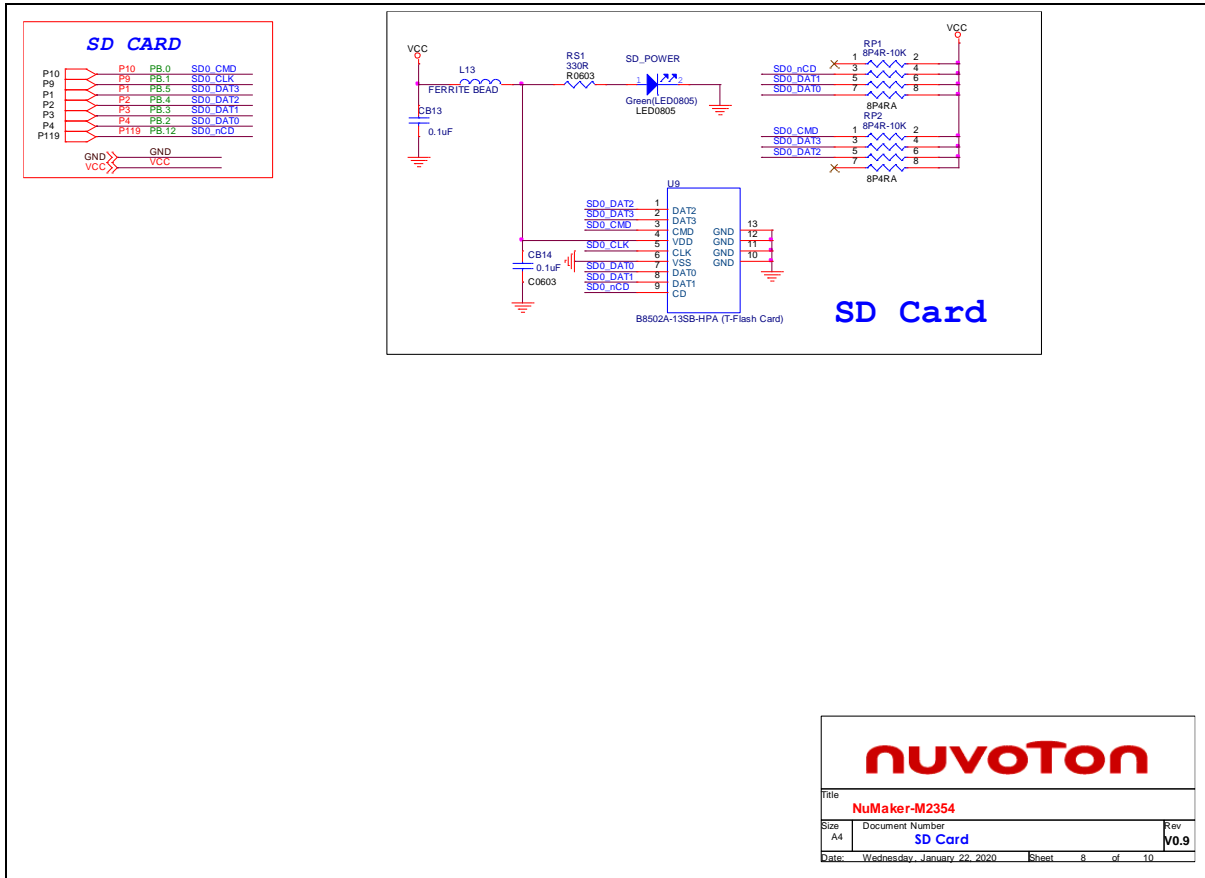

Figure 5-7 MicroSD Card Circuit

### 5.8 Wi-Fi Module (ESP-12)

Figure 5-8 shows the Wi-Fi Module (ESP-12) for wireless application on the NuMaker-M2354 board.

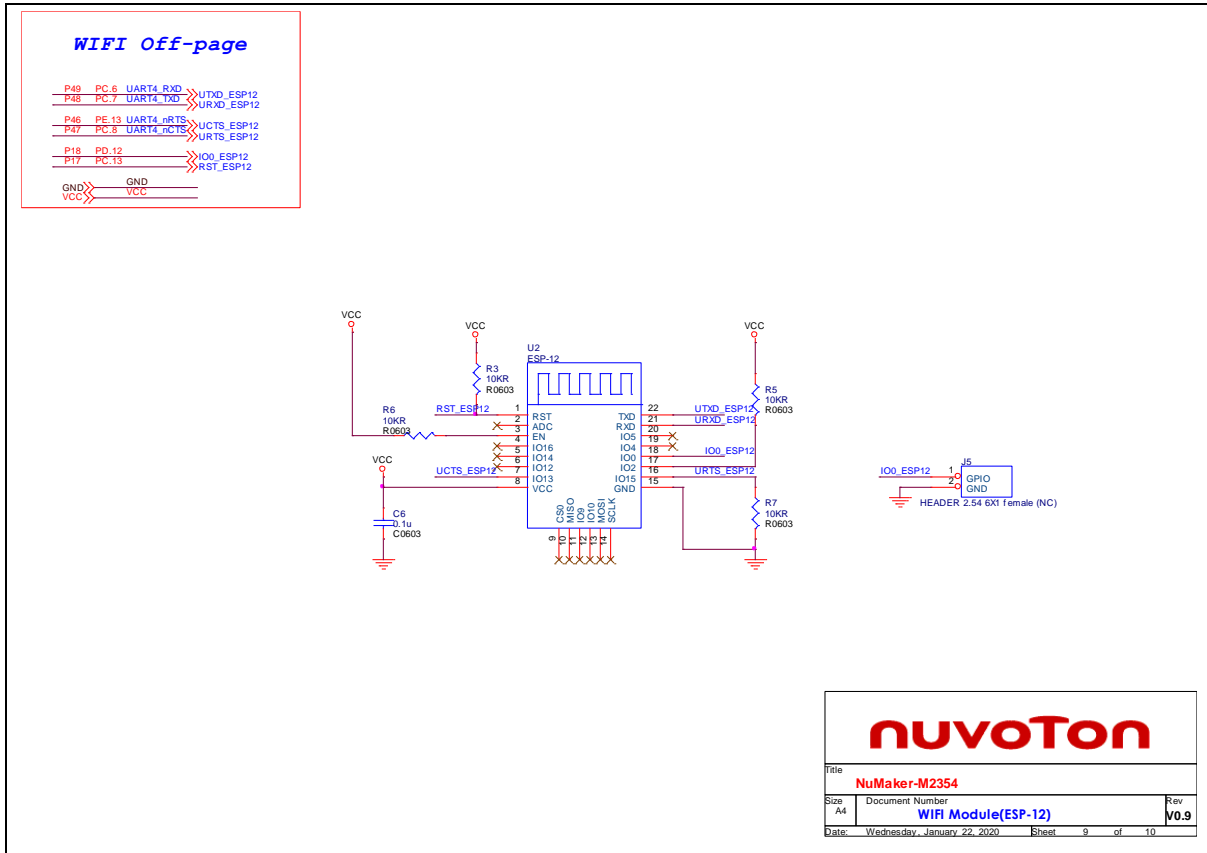

Figure 5-8 Wi-Fi Module Circuit

### 5.9 LCD interface

Figure 5-9 LCD interface Circuit shows the LCD connective interface and LCD panel for display application on the NuMaker-M2354 board.

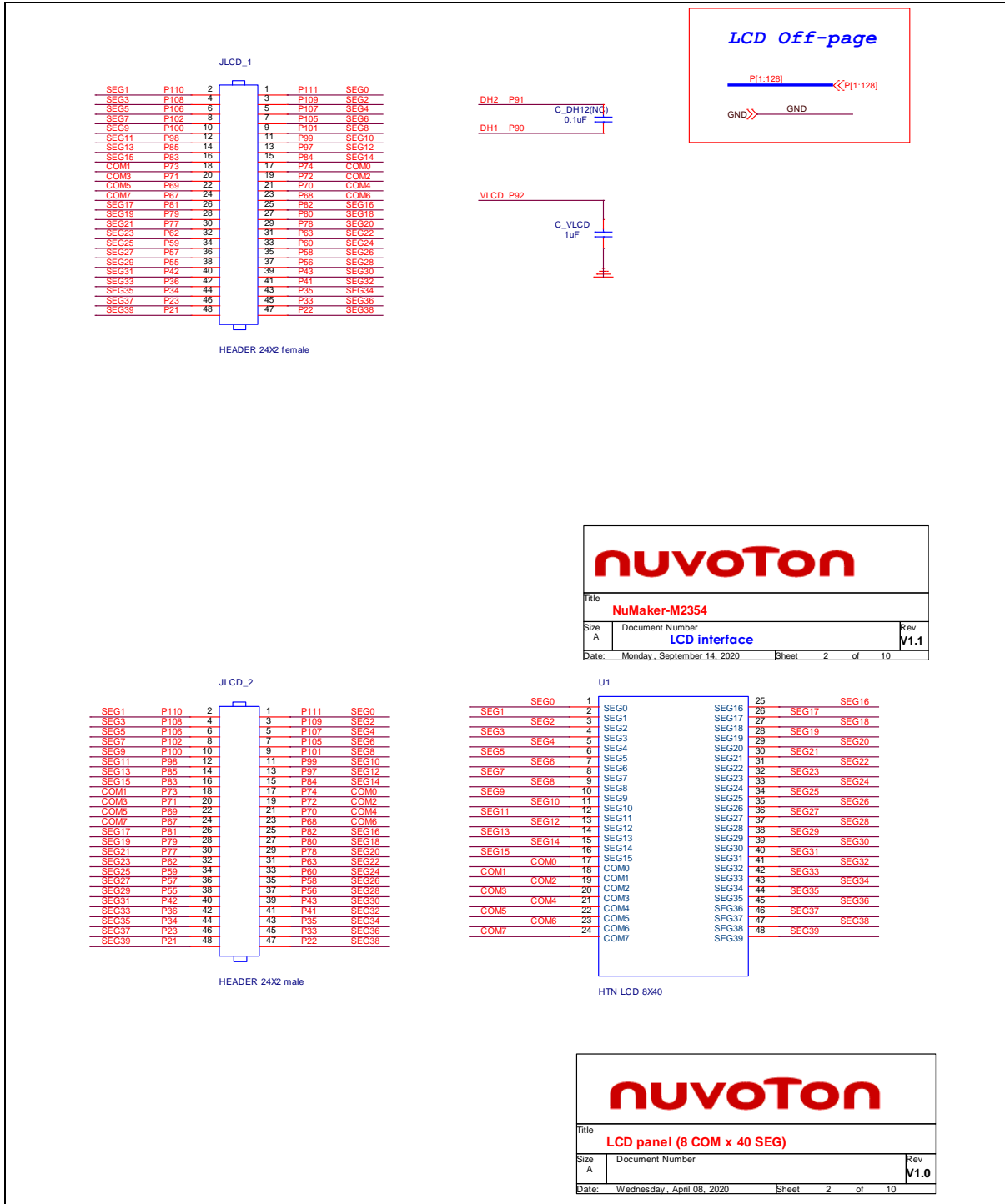

Figure 5-9 LCD interface Circuit

5.10 PCB Placement

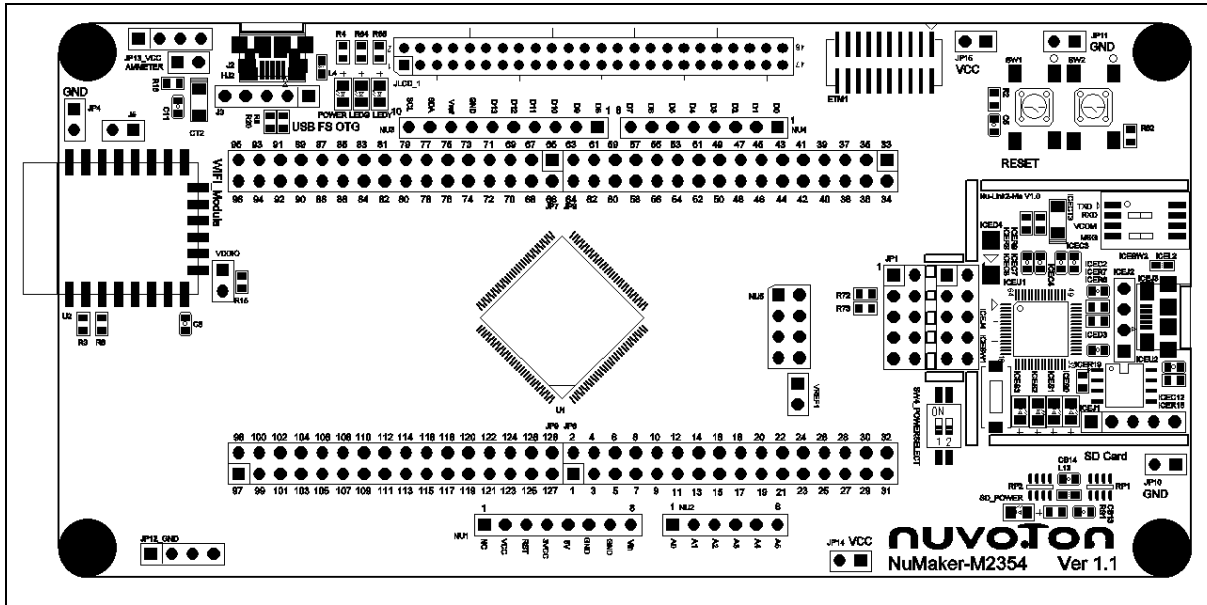

Figure 5-10 Front Placement

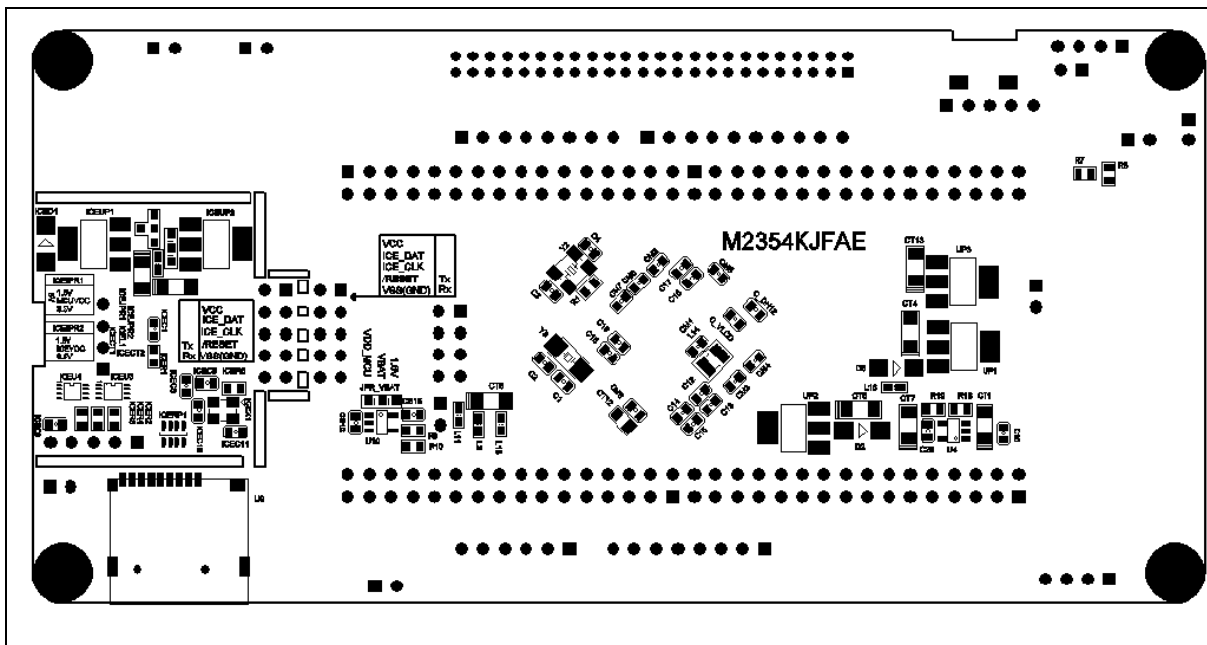

Figure 5-11 Rear Placement



**6 REVISION HISTORY**

Date	Revision	Description
2020.12.25	1.00	1. Initially issued.

### Important Notice

**Nuvoton Products are neither intended nor warranted for usage in systems or equipment, any malfunction or failure of which may cause loss of human life, bodily injury or severe property damage. Such applications are deemed, “Insecure Usage”.**

**Insecure usage includes, but is not limited to: equipment for surgical implementation, atomic energy control instruments, airplane or spaceship instruments, the control or operation of dynamic, brake or safety systems designed for vehicular use, traffic signal instruments, all types of safety devices, and other applications intended to support or sustain life.**

**All Insecure Usage shall be made at customer’s risk, and in the event that third parties lay claims to Nuvoton as a result of customer’s Insecure Usage, customer shall indemnify the damages and liabilities thus incurred by Nuvoton.**

---

*Please note that all data and specifications are subject to change without notice.  
All the trademarks of products and companies mentioned in this datasheet belong to their respective owners.*