

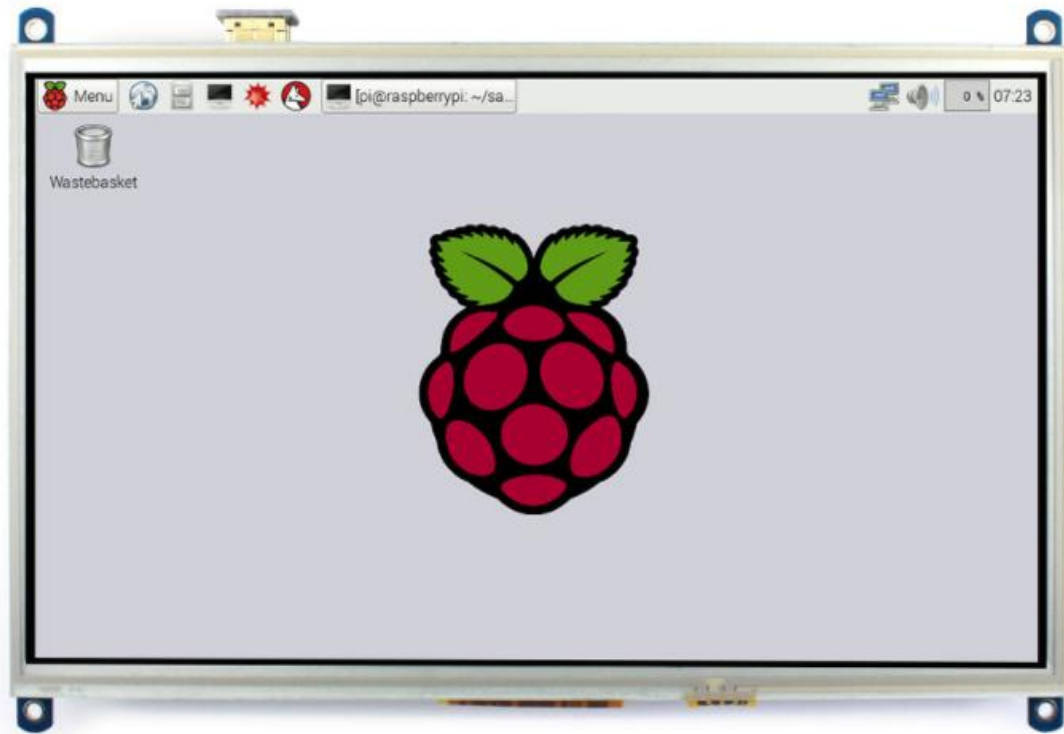







# 10.1" HDMI Touch Display

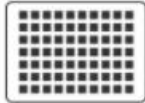

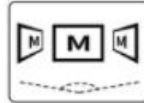
<b>Size</b>  10.1"	<b>Resolution</b>  1024×600	<b>Display Interface</b>  HDMI	<b>Display Panel</b>  IPS	<b>Viewing Angle</b>  170°
<b>Touch Type</b>  Resistive	<b>Touch Port</b>  SPI	<b>OSD Menu</b>  Brightness/Contrast	<b>Certification</b>  CE	

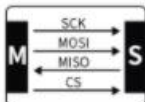
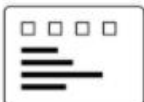
## Device & System Support

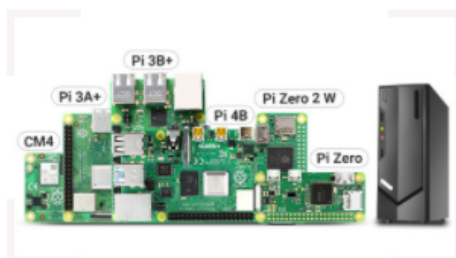

### Raspberry Pi

Directly Pluggable: Raspberry Pi 4B / 3B+ / 3A+ / 3B / 2B / 1B+ / 1A+  
Additional HDMI Cable Required: Raspberry Pi Zero 2 W / Zero W / Zero  
Driver Provided: supports Raspberry Pi OS / Ubuntu / Kali / RetroPie

**Supports future version which is backward compatible**

### PC

Supports Windows 11 / 10 / 8.1 / 8 / 7, no touch (additional HDMI cable required)

# Connection Examples

Working With Raspberry Pi 4



Working With Raspberry Pi 3B+



### Working With Raspberry Pi Zero W



### Working With Mini PC



## Display

IPS Panel

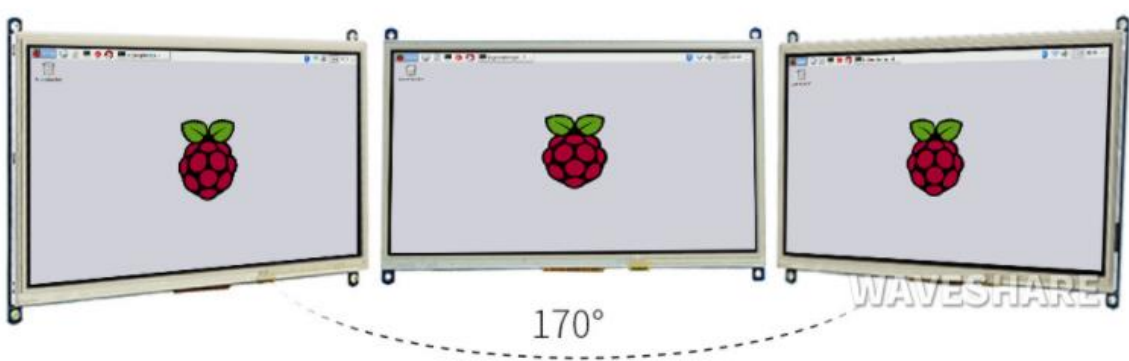

# Touch Control

Comes With Touch Stylus



# Appearance And Dimensions

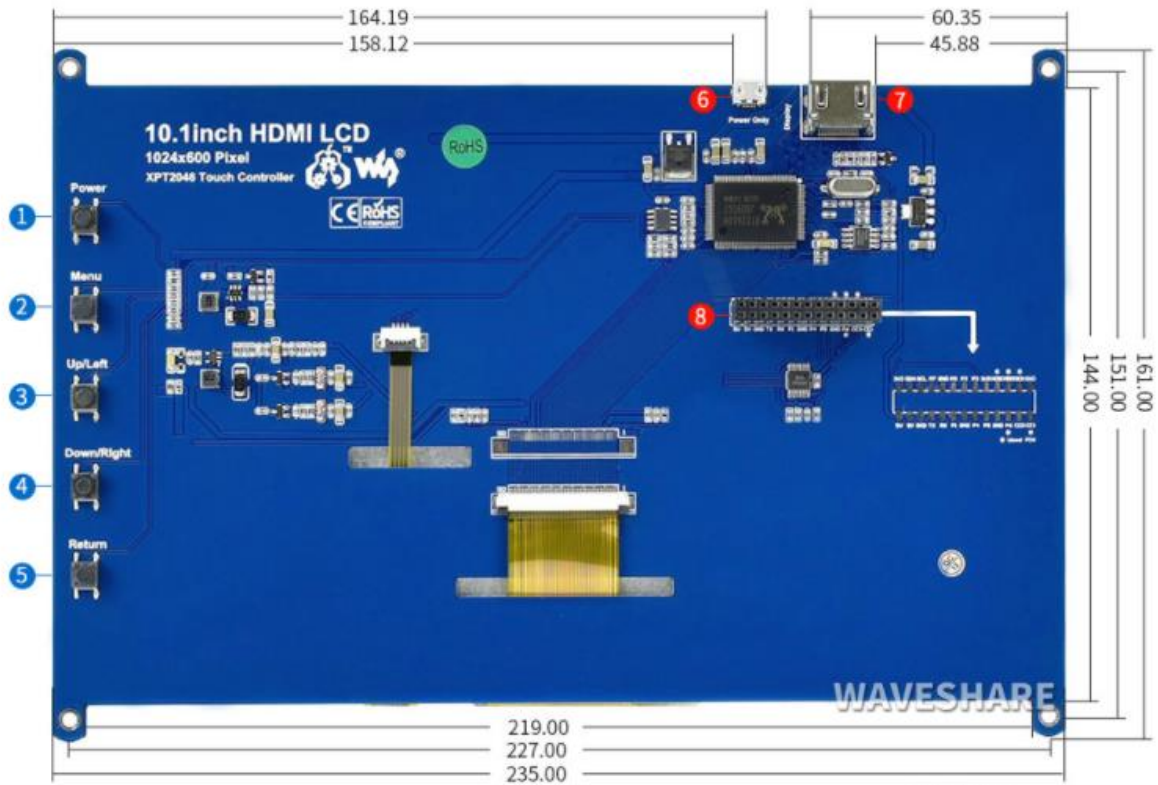

Unit:mm

- |                   |               |               |                  |
|-------------------|---------------|---------------|------------------|
| ① Power Key       | ② Menu Key    | ③ Up/Left Key | ④ Down/Right Key |
| ⑤ Return/Exit Key | ⑥ Power Input | ⑦ HDMI Port   | ⑧ I/O Header     |



# 10.1inch HDMI LCD User Manual

## OVERVIEW

This is 10.1inch resistive touch screen with 1024x600 resolution, HDMI interface, designed for Raspberry Pi

## FEATURES

- 1024x600 hardware resolution
- Resistive touch control
- Compatible and Direct-connect with any revision of Raspberry Pi (except the Pi 1 model B or Pi Zero, which requires an HDMI cable)
- Drivers provided (works with your own Raspbian/Ubuntu/Kali/RetroPie)
- Also works as a computer monitor, in this case, touch panel is unavailable and HDMI cable is required
- HDMI interface for displaying, no I/Os required (however, the touch panel still needs I/Os)
- Backlight can be turned off to lower power consumption

## CONTENT

Overview.....	1
Features.....	1
How to use .....	3
Hardware connection.....	3
Method 1, Install driver .....	3
Method 2 Using ready-to-use image.....	4
Setting orientation .....	4
Calibration .....	5
Interface.....	6

## HOW TO USE

The touch of the LCD can be driven in two ways: Method 1: Install driver manually;

Method 2: Using ready-to-use Image

## HARDWARE CONNECTION

- Insert LCD directly to 40PIN header of Raspberry Pi.
- Using the HDMI adapter or HDMI cable to connect HDMI interface of LCD to Raspberry Pi's

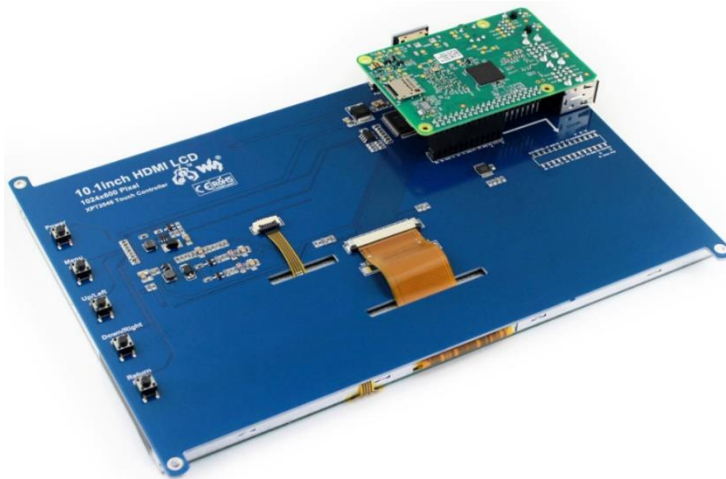

## METHOD 1, INSTALL DRIVER

1. Download latest OS<sup>1</sup> image from [Raspberry Pi website](https://www.raspberrypi.org/).
2. Extract image from ZIP archive and write it to SD card
3. After writing, modify the config.txt file which is located at root directory (BOOT) of SD card. Append these statements to the end of config.txt file

```
max_usb_current=1  
  
hdmi_group=2
```

---

<sup>1</sup> This instruction is based on Raspbian OS



```
hdmi_mode=87

hdmi_cvt 1024 600 60 6 0 0 0

hdmi_drive=1
```

4. Insert SD card to Raspberry Pi and power it on.
5. Connect to network, open terminal to download and install driver.

```
git clone https://github.com/waveshare/LCD-show.git

cd LCD-show/

sudo ./LCD101-1024x600-show
```

6. Waiting for rebooting

## METHOD 2 USING READY-TO-USE IMAGE

1. Download image we provided on wiki
  - Raspbian for [10.1inch HDMI LCD](#)
2. Extract the image file and write to SD card
3. Insert the SD card to Raspberry Pi and power on.

## SETTING ORIENTATION

After installing driver, you can set the orientation as below

```
cd LCD-show/

#Choose one command to execute

sudo ./LCD101-1024x600-show X
```

**【Note】** X can be 0, 90, 180 or 270

## CALIBRATION

If the touch of RPi LCD is not calibrated, you can calibrate the touch screen.

1. Copy and install calibrator tool

```
cp LCD-show/xinput-calibrator_0.7.5-1_armhf.deb ~/
sudo dpkg -i -B xinput-calibrator_0.7.5-1_armhf.deb
```

2. Install X service

```
sudo apt-get install xserver-xorg-input-evdev
sudo cp -rf /usr/share/X11/xorg.conf.d/10-evdev.conf /usr/share/X11/xorg.conf.d/45-evdev.conf
sudo reboot
```

3. Running calibrator and finish calibration

```
DISPLAY=:0.0 xinput_calibrator
```

4. Saving the calibration data to 99-clibration.conf file

```
sudo mkdir /etc/X11/xorg.conf.d
sudo nano /etc/X11/xorg.conf.d/99-calibration.conf
```

The calibration data looks like;

```
Section "InputClass"
    Identifier      "calibration"
    MatchProduct   "ADS7846 Touchscreen"
    Option "Calibration" "208 3905 288 3910"
    Option "SwapAxes" "0"
EndSection
```

## INTERFACE

PIN NO.	Symbol	Description
1, 17	3.3V	Power positive (3.3V power input)
2, 4	5V	Power positive (5V power input)
3, 5, 7, 8, 10, 11, 12, 13, 15, 16, 18, 24	NC	NC
6, 9, 14, 20, 25	GND	Ground
19	TP_SI	SPI data input of Touch Panel
21	TP_SO	SPI data output of Touch Panel
22	TP_IRQ	Touch Panel interrupt, low level while the Touch Panel detects touching
23	TP_SCK	SPI clock of Touch Panel
26	TP_CS	Touch Panel chip selection, low active

## PACKAGE CONTENT

Weight: 0.537 kg

10.1inch HDMI LCD x1

HDMI Adapter (A) x1

HDMI Adapter (B) x1

Touch stylus x1

RPi screws pack (4pcs) x1

1

