

HERMETICALLY SEALED GLASS ZENER VOLTAGE REGULATORS

FEATURES:

- Zener Voltage Range 3 to 75 Volts
- Through-Hole Device Type Mounting
- DO-41 Glass Package (JEDEC)
- Hermetically Sealed Glass
- Compression Bonded Construction
- All external surfaces are Corrosion Resistant And Leads Are Readily Solderable
- RoHS Compliant
- Solder Hot Dip Tin (Sn) Terminal Finish Cathode Indicated By Polarity Band

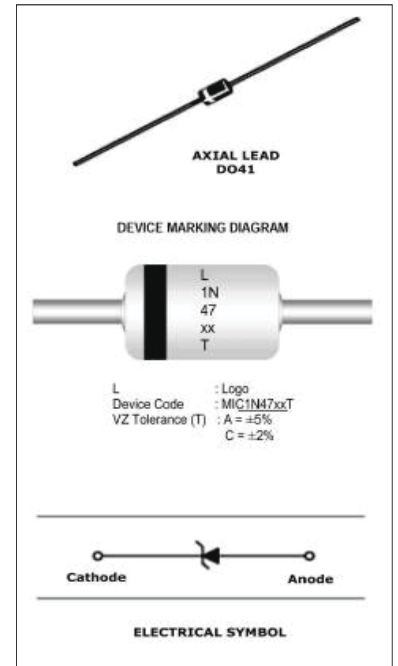

ABSOLUTE MAXIMUM RATINGS TA=25 °C unless otherwise noted

Parameter	Value	Units
Storage Temperature Range	-65 to +200	°C
Maximum Junction Operating Temperature	+200	°C
Total Device Dissipation	1.0	Watt
Thermal Resistance Junction to Lead	53.5	°C / W
Thermal Resistance Junction to Ambient	100	Watt

These ratings are limiting values above which the serviceability of the diode may be impaired.

ELECTRICAL CHARACTERISTICS TA=25 °C unless otherwise noted

Type	Zener Voltage ³⁾		Dynamic Resistance ¹⁾			Reverse Current		Maximum Surge Current ⁴⁾	Maximum Regulator Current ²⁾
	V _{Znom}	at I _{ZT}	Z _{ZT}	Z _{ZK}	at I _{ZK}	I _R	at V _R	at T _a = 25 °C	
	(V)	(mA)	Max. (Ω)	Max. (Ω)	(mA)	Max. (μA)	(V)	I _{ZSM} (mA)	I _{ZM} (mA)
1N4727A	3	83	10	400	1	150	1	1375	275
1N4728A	3.3	76	10	400	1	150	1	1375	275
1N4729A	3.6	69	10	400	1	100	1	1260	252
1N4730A	3.9	64	9	400	1	100	1	1190	234
1N4731A	4.3	58	9	400	1	50	1	1070	217
1N4732A	4.7	53	8	500	1	10	1	970	193
1N4733A	5.1	49	7	550	1	10	1	890	178
1N4734A	5.6	45	5	600	1	10	2	810	162
1N4735A	6.2	41	2	700	1	10	3	730	146
1N4736A	6.8	37	3.5	700	1	10	4	660	133
1N4737A	7.5	34	4	700	0.5	10	5	605	121
1N4738A	8.2	31	4.5	700	0.5	10	6	550	110
1N4739A	9.1	28	5	700	0.5	10	7	500	100
1N4740A	10	25	7	700	0.25	10	7.6	454	91

HERMETICALLY SEALED GLASS ZENER VOLTAGE REGULATORS

ELECTRICAL CHARACTERISTICS TA=25 °C unless otherwise noted

Type	Zener Voltage ³⁾		Dynamic Resistance ¹⁾			Reverse Current		Maximum Surge Current ⁴⁾	Maximum Regulator Current ²⁾
	V _{Znom}	at I _{ZT}	Z _{ZT}	Z _{ZK}	at I _{ZK}	I _R	at V _R	at T _a = 25 °C	
	(V)	(mA)	Max. (Ω)	Max. (Ω)	(mA)	Max. (μA)	(V)	I _{ZSM} (mA)	I _{ZM} (mA)
1N4741A	11	23	8	700	0.25	5	8.4	414	83
1N4742A	12	21	9	700	0.25	5	9.1	380	76
1N4743A	13	19	10	700	0.25	5	9.9	344	69
1N4744A	15	17	14	700	0.25	5	11.4	304	61
1N4745A	16	15.5	16	700	0.25	5	12.2	285	57
1N4746A	18	14	20	750	0.25	5	13.7	250	50
1N4747A	20	12.5	22	750	0.25	5	15.2	225	45
1N4748A	22	11.5	23	750	0.25	5	16.7	205	41
1N4749A	24	10.5	25	750	0.25	5	18.2	190	38
1N4750A	27	9.5	35	750	0.25	5	20.6	170	34
1N4751A	30	8.5	40	1000	0.25	5	22.8	150	30
1N4752A	33	7.5	45	1000	0.25	5	25.1	135	27
1N4753A	36	7	50	1000	0.25	5	27.4	125	25
1N4754A	39	6.5	60	1000	0.25	5	29.7	115	23
1N4755A	43	6	70	1500	0.25	5	32.7	110	22
1N4756A	47	5.5	80	1500	0.25	5	35.8	95	19
1N4757A	51	5	95	1500	0.25	5	38.8	90	18
1N4758A	56	4.5	110	2000	0.25	5	42.6	80	16
1N4759A	62	4	125	2000	0.25	5	47.1	70	14
1N4760A	68	3.7	150	2000	0.25	5	51.7	65	13
1N4761A	75	3.3	175	2000	0.25	5	56	60	12

Notes:

1. TOLERANCE AND TYPE NUMBER DESIGNATION (V_Z)

The type numbers listed have a standard tolerance on the nominal zener voltage +5%. Device tolerance of +2% is indicated by a "C" instead of an "A"

2. SPECIALS AVAILABLE INCLUDE

Nominal zener voltages between the voltages shown and tighter voltage. for detailed information on price, availability and delivery, contact us.

3. ZENER VOLTAGE (V_Z) MEASUREMENT

The zener voltage (V_Z) is tested under pulse condition. The measured V_Z is guaranteed to be within specification with device junction in thermal equilibrium.

4. ZENER IMPEDANCE (Z_Z) DERIVATION

The zener impedance is derived from the 60 cycle AC voltage, which results when an AC current having an RMS value equal to 10% of the DC zener current (I_{ZT} or I_{ZK}) is superimposed on I_{ZT} or I_{ZK}.

HERMETICALLY SEALED GLASS ZENER VOLTAGE REGULATORS

Typical Characteristics

Breakdown characteristics

$T_j = \text{constant (pulsed)}$

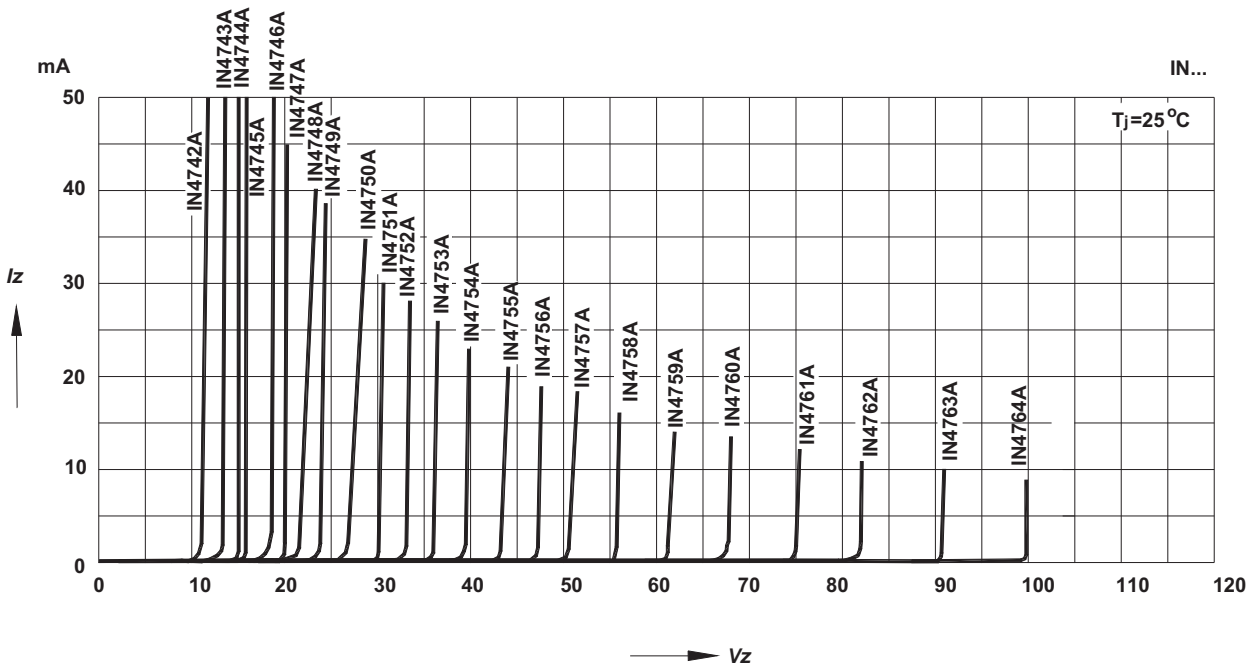
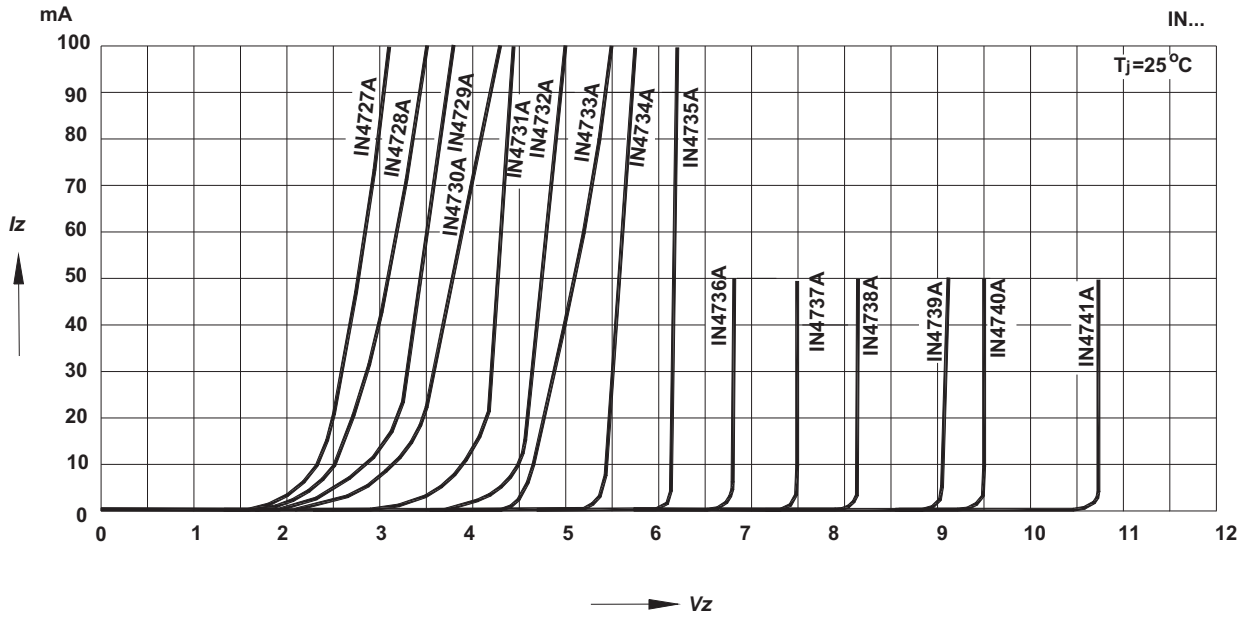

HERMETICALLY SEALED GLASS ZENER VOLTAGE REGULATORS

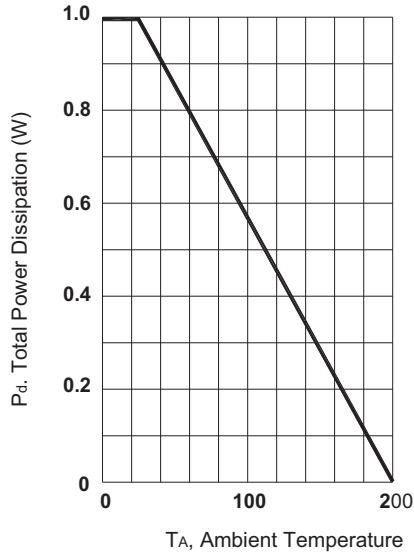

Fig. 1 Power Dissipation vs Ambient Temperature

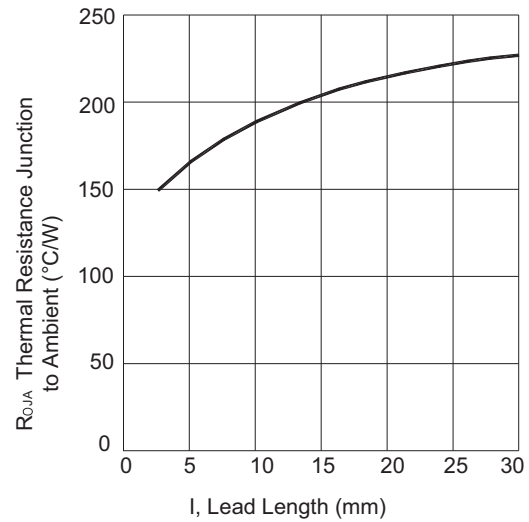

Fig. 2 Typical Thermal Resistance vs. Lead Length

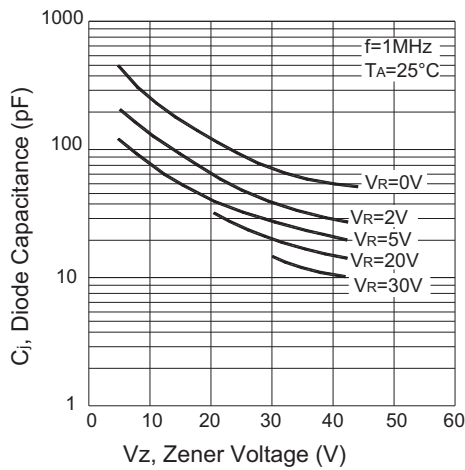

Fig. 3 Junction Capacitance vs Zener Voltage

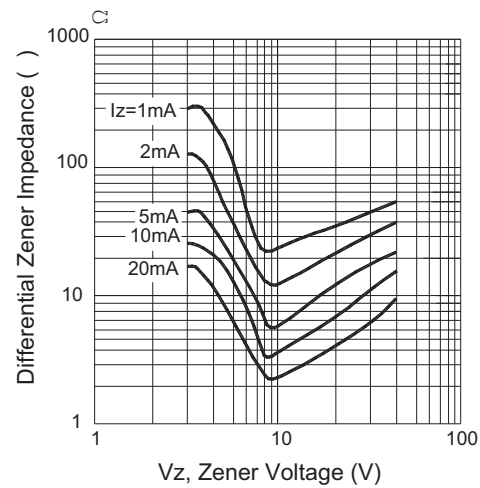
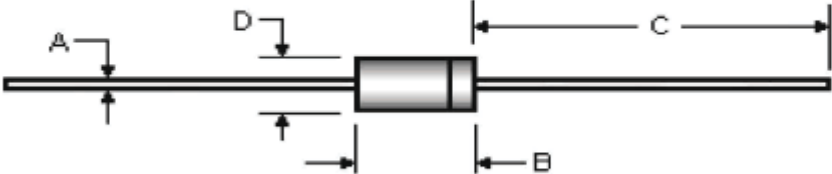

Fig. 4 Typical Zener Impedance vs. Zener Voltage

HERMETICALLY SEALED GLASS ZENER VOLTAGE REGULATORS

PACKAGE OUTLINE

DO-41

Package	Case Outline				
DO-41					
	DO-41				
	DIM	Millimeters		Inches	
		Min	Max	Min	Max
	A	0.72	0.86	0.028	0.034
	B	4.07	5.20	0.160	0.205
C	25.40	---	1.000	---	
D	2.04	2.71	0.080	0.107	

Notes:

1. All dimensions are within JEDEC standard.
2. DO41 polarity denoted by cathode band.

Disclaimer

All product, product specifications and data are subject to change without notice to improve reliability, function or design or otherwise.