

## Integrated Current Sensor HMSR-SMS series

$$I_{PN} = 6 \dots 30 \text{ A}$$

Ref: HMSR 6-SMS, HMSR 8-SMS, HMSR 10-SMS, HMSR 15-SMS,  
HMSR 20-SMS, HMSR 30-SMS

### Definition

The HMSR is a new generation of high insulated Integrated Current Sensor from LEM.

These product family provides a robust, compact and very accurate solution for measuring DC and AC currents in all highly demanding, switching power applications for commercial, industrial and automotive markets. HMSR is a micro core based open loop sensor with a reinforced insulation and overcurrent detections (user configurable and factory set). These features make the device suitable for high voltage applications requiring high precision and strong immunity against external field.

The primary conductor (pins 1 and 8) has very low electrical resistance and dedicated pads designed to withstand against high surge currents such as lightning strikes.

HMSR is measuring the magnetic field generated by the current flowing in the copper primary path of the device. By using a micro magnetic core, HMSR is immune to the external fields, making the device well suited for power electronic applications with high levels of disturbance.

The reinforced isolation between primary (pins 1 and 8) and secondary (pins 9 to 15) offers the HMSR, a small, cost effective solution to measure high side current compared to resistive isolated solutions.

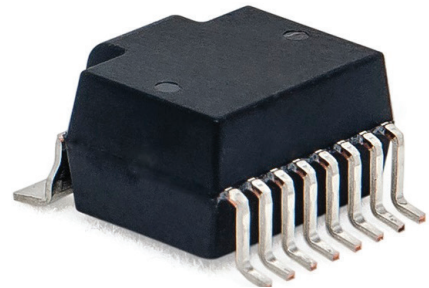

### Features

- Open loop multi-range current transducer
- Voltage output
- Double overcurrent detection
- Single power supply +5 V
- Galvanic separation between primary and secondary
- Low power consumption
- Compact design for surface mount PCB mounting
- Factory calibrated
- High bandwidth, very low loss magnetic core.

### Advantages

- Low profile: h = 6 mm
- Small foot-print
- Low electrical resistance 0.76 mΩ
- Reinforced insulation capability
- High resolution
- High immunity to external interference
- Lightning impulse current  $\leq 20 \text{ kA}$ .

### Applications

- Small drives
- HVAC Inverters
- Appliances
- Solar Inverters.

### Standards

- IEC 61800-5-1: 2007
- IEC 62109-1: 2010
- IEC 60950-1: 2005
- UL 1577: 2014 (pending).

### Application Domain

- Industrial.

## Safety



Caution

If the device is used in a way that is not specified by the manufacturer, the protection provided by the device may be compromised. Always inspect the electronics unit and connecting cable before using this product and do not use it if damaged. Mounting assembly shall guarantee the maximum primary conductor temperature, fulfill clearance and creepage distance, minimize electric and magnetic coupling, and unless otherwise specified can be mounted in any orientation.



Caution, risk of electrical shock

This transducer must be used in limited-energy secondary circuits SELV according to IEC 61010-1, in electric/electronic equipment with respect to applicable standards and safety requirements in accordance with the manufacturer's operating specifications.

Use caution during installation and use of this product; certain parts of the module can carry hazardous voltages and high currents (e.g. power supply, primary conductor).

Ignoring this warning can lead to injury and or/or cause serious damage.

De-energize all circuits and hazardous live parts before installing the product.

All installations, maintenance, servicing operations and use must be carried out by trained and qualified personnel practicing applicable safety precautions.

This transducer is a build-in device, whose hazardous live parts must be inaccessible after installation.

This transducer must be mounted in a suitable end-enclosure.

Main supply must be able to be disconnected.

This transducer is a built-in device, not intended to be cleaned with any product. Nevertheless if the user must implement cleaning or washing process, validation of the cleaning program has to be done by the user in accordance with semi-conductor practices.



ESD susceptibility

The product is susceptible to be damaged from an ESD event and the personnel and work space should be grounded when handling it.

Do not dispose of this product as unsorted municipal waste. Contact a qualified recycler for disposal.

Although LEM applies utmost care to facilitate compliance of end products with applicable regulations during LEM product design, use of this part may need additional measures on the application side for compliance with regulations regarding EMC and protection against electric shock. Therefore LEM cannot be held liable for any potential hazards, damages, injuries or loss of life resulting from the use of this product.

**Absolute maximum ratings**

| Parameter                                                    | Symbol         | Unit | Value |
|--------------------------------------------------------------|----------------|------|-------|
| Maximum supply voltage                                       | $U_{C\ max}$   | V    | 8     |
| Maximum supply voltage (working) (-40 ... 125 °C)            | $U_{C\ max}$   | V    | 6.5   |
| Electrostatic discharge voltage (HBM - Human Body Model)     | $U_{ESD\ HBM}$ | kV   | 2     |
| Electrostatic discharge voltage (CDM - Charged Device Model) | $U_{ESD\ CDM}$ | V    | 500   |
| Maximum output current source                                | $I_{out\ max}$ | mA   | 25    |
| Maximum input current sink                                   | $I_{in\ max}$  | mA   | 50    |
| Maximum junction temperature                                 | $T_{J\ max}$   | °C   | 150   |

Absolute maximum ratings apply at 25 °C unless otherwise noted.  
 Stresses above these ratings may cause permanent damage.  
 Exposure to absolute maximum ratings for extended periods may degrade reliability.

**Environmental and mechanical characteristics**

| Parameter                                            | Symbol     | Unit | Min | Typ  | Max | Comment |
|------------------------------------------------------|------------|------|-----|------|-----|---------|
| Ambient operating temperature                        | $T_A$      | °C   | -40 |      | 125 |         |
| Ambient storage temperature                          | $T_S$      | °C   | -55 |      | 165 |         |
| Resistance of the primary @ $T_A = 25$ °C            | $R_P$      | mΩ   |     | 0.76 |     |         |
| Thermal resistance junction to case <sup>1)</sup>    | $R_{thJC}$ | K/W  |     | 18   |     |         |
| Thermal resistance junction to ambient <sup>1)</sup> | $R_{thJA}$ | K/W  |     | 19   |     |         |
| Mass                                                 | $m$        | g    |     | 1.4  |     |         |

**Insulation coordination**

| Parameter                                          | Symbol   | Unit | ≤ Value | Comment                                                                                 |
|----------------------------------------------------|----------|------|---------|-----------------------------------------------------------------------------------------|
| RMS voltage for AC insulation test, 50 Hz, 1 min   | $U_d$    | kV   | 4.95    | According to IEC 60950-1                                                                |
| Impulse withstand voltage 1.2/50 μs                | $U_{Ni}$ | kV   | 8       | According to IEC 62109-1, IEC 61800-5-1                                                 |
| Partial discharge RMS test voltage ( $q_m < 5$ pC) | $U_t$    | V    | 1650    | According to IEC 62109-1, IEC 61800-5-1                                                 |
| Clearance (pri. - sec.)                            | $d_{Cl}$ | mm   | 8       | Shortest distance through air                                                           |
| Creepage distance (pri. - sec.)                    | $d_{Cp}$ | mm   | 8       | Shortest path along device body                                                         |
| Case material                                      | -        | -    | V0      | According to UL 94, flammability                                                        |
| Comparative tracking index                         | $CTI$    |      | 600     | grade requirements mas compand                                                          |
| Application example<br>System voltage RMS          |          | V    | 1000    | Basic insulation according to IEC 61800-5-1, IEC 62109-1, IEC 60950-1 CAT III, PD2      |
| Application example<br>System voltage RMS          |          | V    | 600     | Reinforced insulation according to IEC 61800-5-1, IEC 62109-1, IEC 60950-1 CAT III, PD2 |
| Application example<br>System voltage DC           |          | V    | 1500    | Basic insulation according to IEC 62109-1 CAT III, PD2                                  |
| Application example<br>System voltage DC           |          | V    | 800     | Reinforced insulation according to IEC 62109-1 CAT III, PD2                             |

Note: <sup>1)</sup> Done on LEM evaluation board PCB 6030:  
<https://www.lem.com/en/hmsr-miniature-current-sensors>.

**Electrical data HMSR 6-SMS**

At  $T_A = 25\text{ °C}$ ,  $U_C = 5\text{ V}$ ,  $R_L = 10\text{ k}\Omega$ , unless otherwise noted (see Min, Max, typ, definition paragraph in page 11).

| Parameter                                                                           | Symbol                 | Unit                          | Min    | Typ                  | Max   | Comment                                          |
|-------------------------------------------------------------------------------------|------------------------|-------------------------------|--------|----------------------|-------|--------------------------------------------------|
| Primary nominal current                                                             | $I_{PN}$               | A                             |        | 6                    |       |                                                  |
| Primary current, measuring range                                                    | $I_{PM}$               | A                             | -15    |                      | 15    | With $\pm U_C \geq 4.6\text{ V}$                 |
| Internal reference voltage @ $I_P = 0\text{ A}$                                     | $U_{Iref}$             | V                             | 2.48   | 2.5                  | 2.52  |                                                  |
| Output voltage range @ $I_{PM}$                                                     | $U_{out} - U_{ref}$    | V                             | -2     |                      | 2     |                                                  |
| Output Internal resistance of $U_{out}$                                             | $R_{out}$              | $\Omega$                      |        | 2                    | 5     |                                                  |
| Output Internal resistance of $U_{ref}$                                             | $R_{ref}$              | $\Omega$                      | 120    | 200                  | 333   |                                                  |
| Load capacitance on $U_{out}$                                                       | $C_L$                  | nF                            | 0      | 4.7                  | 6     |                                                  |
| Load capacitance on $U_{ref}$                                                       | $C_L$                  | nF                            | 0      | 47                   | 100   |                                                  |
| DC supply voltage =                                                                 | $U_C$                  | V                             | 4.5    | 5                    | 5.5   |                                                  |
| DC current consumption =                                                            | $I_C$                  | mA                            |        | 20                   | 26    |                                                  |
| Nominal sensitivity                                                                 | $S_N$                  | mV/A                          |        | 133.33               |       | 800 mV @ $I_{PN}$                                |
| Sensitivity error                                                                   | $\varepsilon_S$        | %                             | -0.75  |                      | 0.75  | Factory adjustment                               |
| Sum of sensitivity and linearity error @ $T_A = 25\text{ °C}$                       | $\varepsilon_{SL25}$   | % of $I_{PN}$                 | -1.5   |                      | 1.5   |                                                  |
| Electrical offset voltage referred to primary                                       | $U_{OE}$               | mV                            | -5     |                      | 5     | $U_{out} - U_{Iref}$ @ $U_{Iref} = 2.5\text{ V}$ |
| Electrical offset current referred to primary                                       | $I_{OE}$               | mA                            | -37.5  |                      | 37.5  |                                                  |
| Temperature coefficient of $S$                                                      | $TCS$                  | ppm/K                         | -200   |                      | 200   | -40 °C ... 125 °C                                |
| Temperature coefficient of $U_{Iref}$                                               | $TCU_{Iref}$           | ppm/K                         | -150   |                      | 150   | -40 °C ... 125 °C                                |
| Temperature coefficient of $U_{OE}$                                                 | $TCU_{OE}$             | mV/K                          | -0.075 |                      | 0.075 | -40 °C ... 125 °C                                |
| Temperature coefficient of $I_{OE}$ referred to primary                             | $TCI_{OE}$             | mA/K                          | -0.56  |                      | 0.56  | -40 °C ... 125 °C                                |
| Magnetic offset current after overload ( $I_P > 500\text{ A}$ ) referred to primary | $I_{OM}$               | A                             |        | 0.18                 |       |                                                  |
| Noise voltage spectral density referred to primary                                  | $u_{no}$               | $\mu\text{V}/\text{Hz}^{1/2}$ |        | 14.8                 |       | 100 Hz ... 100 kHz                               |
| Internal OCD detection threshold                                                    | $I_{IOCDTh}$           | A                             |        | $2.75 \times I_{PN}$ |       | 25 °C ... 125 °C                                 |
| Internal OCD threshold error                                                        | $\varepsilon_{IOCDTh}$ | %                             |        | $\pm 10$             |       | Referred to $I_{PN}$                             |
| Internal OCD output on resistance                                                   | $R_{onIOCD}$           | $\Omega$                      | 70     | 95                   | 100   | Open drain output, active low                    |
| Linearity error 0 ... $\pm I_{PN}$                                                  | $\varepsilon_L$        | %                             | -0.75  |                      | 0.75  | Referred to $I_{PN}$                             |
| Linearity error 0 ... $\pm I_{PM}$                                                  | $\varepsilon_L$        | %                             | -0.5   |                      | 0.5   | Referred to $I_{PM}$                             |
| Delay time @ 10 % of $I_{PN}$                                                       | $t_{D10}$              | $\mu\text{s}$                 |        |                      | 1.5   |                                                  |
| Delay time @ 90 % of $I_{PN}$                                                       | $t_{D90}$              | $\mu\text{s}$                 |        |                      | 2     |                                                  |
| Internal OCD delay time                                                             | $t_{DIOCD}$            | $\mu\text{s}$                 | 1.4    | 1.7                  | 2.1   |                                                  |
| Frequency bandwidth (-3 dB)                                                         | $BW$                   | kHz                           |        | 300                  |       |                                                  |
| Internal OCD output hold time                                                       | $t_{holdIOCD}$         | $\mu\text{s}$                 | 7      | 10                   | 14    |                                                  |

**Electrical data HMSR 8-SMS**

At  $T_A = 25\text{ °C}$ ,  $U_C = 5\text{ V}$ ,  $R_L = 10\text{ k}\Omega$ , unless otherwise noted (see Min, Max, typ, definition paragraph in page 11).

| Parameter                                                                           | Symbol                         | Unit                          | Min    | Typ                  | Max   | Comment                                          |
|-------------------------------------------------------------------------------------|--------------------------------|-------------------------------|--------|----------------------|-------|--------------------------------------------------|
| Primary nominal current                                                             | $I_{PN}$                       | A                             |        | 8                    |       |                                                  |
| Primary current, measuring range                                                    | $I_{PM}$                       | A                             | -20    |                      | 20    | With $\pm U_C \geq 4.6\text{ V}$                 |
| Internal reference voltage @ $I_P = 0\text{ A}$                                     | $U_{Iref}$                     | V                             | 2.48   | 2.5                  | 2.52  |                                                  |
| Output voltage range @ $I_{PM}$                                                     | $U_{out} - U_{ref}$            | V                             | -2     |                      | 2     |                                                  |
| Output Internal resistance of $U_{out}$                                             | $R_{out}$                      | $\Omega$                      |        | 2                    | 5     |                                                  |
| Output Internal resistance of $U_{ref}$                                             | $R_{ref}$                      | $\Omega$                      | 120    | 200                  | 333   |                                                  |
| Load capacitance on $U_{out}$                                                       | $C_L$                          | nF                            | 0      | 4.7                  | 6     |                                                  |
| Load capacitance on $U_{ref}$                                                       | $C_L$                          | nF                            | 0      | 47                   | 100   |                                                  |
| DC supply voltage =                                                                 | $U_C$                          | V                             | 4.5    | 5                    | 5.5   |                                                  |
| DC current consumption =                                                            | $I_C$                          | mA                            |        | 20                   | 26    |                                                  |
| Nominal sensitivity                                                                 | $S_N$                          | mV/A                          |        | 100                  |       | 800 mV @ $I_{PN}$                                |
| Sensitivity error                                                                   | $\varepsilon_S$                | %                             | -0.75  |                      | 0.75  | Factory adjustment                               |
| Sum of sensitivity and linearity error @ $T_A = 25\text{ °C}$                       | $\varepsilon_{SL25}$           | % of $I_{PN}$                 | -1.5   |                      | 1.5   |                                                  |
| Electrical offset voltage referred to primary                                       | $U_{OE}$                       | mV                            | -5     |                      | 5     | $U_{out} - U_{Iref}$ @ $U_{Iref} = 2.5\text{ V}$ |
| Electrical offset current referred to primary                                       | $I_{OE}$                       | mA                            | -50    |                      | 50    |                                                  |
| Temperature coefficient of $S$                                                      | $TCS$                          | ppm/K                         | -200   |                      | 200   | -40 °C ... 125 °C                                |
| Temperature coefficient of $U_{Iref}$                                               | $TCU_{Iref}$                   | ppm/K                         | -150   |                      | 150   | -40 °C ... 125 °C                                |
| Temperature coefficient of $U_{OE}$                                                 | $TCU_{OE}$                     | mV/K                          | -0.075 |                      | 0.075 | -40 °C ... 125 °C                                |
| Temperature coefficient of $I_{OE}$ referred to primary                             | $TCI_{OE}$                     | mA/K                          | -0.75  |                      | 0.75  | -40 °C ... 125 °C                                |
| Magnetic offset current after overload ( $I_p > 500\text{ A}$ ) referred to primary | $I_{OM}$                       | A                             |        | 0.18                 |       |                                                  |
| Noise voltage spectral density referred to primary                                  | $u_{no}$                       | $\mu\text{V}/\text{Hz}^{1/2}$ |        | 12.2                 |       | 100 Hz ... 100 kHz                               |
| Internal OCD detection threshold                                                    | $I_{I\text{OCD Th}}$           | A                             |        | $2.75 \times I_{PN}$ |       | 25 °C ... 125 °C                                 |
| Internal OCD threshold error                                                        | $\varepsilon_{I\text{OCD Th}}$ | %                             |        | $\pm 10$             |       | Referred to $I_{PN}$                             |
| Internal OCD output on resistance                                                   | $R_{on\text{I OCD}}$           | $\Omega$                      | 70     | 95                   | 100   | Open drain output, active low                    |
| Linearity error 0 ... $\pm I_{PN}$                                                  | $\varepsilon_L$                | %                             | -0.75  |                      | 0.75  | Referred to $I_{PN}$                             |
| Linearity error 0 ... $\pm I_{PM}$                                                  | $\varepsilon_L$                | %                             | -0.5   |                      | 0.5   | Referred to $I_{PM}$                             |
| Delay time @ 10 % of $I_{PN}$                                                       | $t_{D10}$                      | $\mu\text{s}$                 |        |                      | 1.5   |                                                  |
| Delay time @ 90 % of $I_{PN}$                                                       | $t_{D90}$                      | $\mu\text{s}$                 |        |                      | 2     |                                                  |
| Internal OCD delay time                                                             | $t_{D\text{I OCD}}$            | $\mu\text{s}$                 | 1.4    | 1.7                  | 2.1   |                                                  |
| Frequency bandwidth (-3 dB)                                                         | $BW$                           | kHz                           |        | 300                  |       |                                                  |
| Internal OCD output hold time                                                       | $t_{\text{hold I OCD}}$        | $\mu\text{s}$                 | 7      | 10                   | 14    |                                                  |

**Electrical data HMSR 10-SMS**

At  $T_A = 25\text{ °C}$ ,  $U_C = 5\text{ V}$ ,  $R_L = 10\text{ k}\Omega$ , unless otherwise noted (see Min, Max, typ, definition paragraph in page 11).

| Parameter                                                                           | Symbol                              | Unit                          | Min    | Typ                  | Max   | Comment                                          |
|-------------------------------------------------------------------------------------|-------------------------------------|-------------------------------|--------|----------------------|-------|--------------------------------------------------|
| Primary nominal current                                                             | $I_{PN}$                            | A                             |        | 10                   |       |                                                  |
| Primary current, measuring range                                                    | $I_{PM}$                            | A                             | -25    |                      | 25    | With $\pm U_C \geq 4.6\text{ V}$                 |
| Internal reference voltage @ $I_p = 0\text{ A}$                                     | $U_{Iref}$                          | V                             | 2.48   | 2.5                  | 2.52  |                                                  |
| Output voltage range @ $I_{PM}$                                                     | $U_{out} - U_{ref}$                 | V                             | -2     |                      | 2     |                                                  |
| Output Internal resistance of $U_{out}$                                             | $R_{out}$                           | $\Omega$                      |        | 2                    | 5     |                                                  |
| Output Internal resistance of $U_{ref}$                                             | $R_{ref}$                           | $\Omega$                      | 120    | 200                  | 333   |                                                  |
| Load capacitance on $U_{out}$                                                       | $C_L$                               | nF                            | 0      | 4.7                  | 6     |                                                  |
| Load capacitance on $U_{ref}$                                                       | $C_L$                               | nF                            | 0      | 47                   | 100   |                                                  |
| DC supply voltage =                                                                 | $U_C$                               | V                             | 4.5    | 5                    | 5.5   |                                                  |
| DC current consumption =                                                            | $I_C$                               | mA                            |        | 20                   | 26    |                                                  |
| Nominal sensitivity                                                                 | $S_N$                               | mV/A                          |        | 80                   |       | 800 mV @ $I_{PN}$                                |
| Sensitivity error                                                                   | $\epsilon_S$                        | %                             | -0.75  |                      | 0.75  | Factory adjustment                               |
| Sum of sensitivity and linearity error @ $T_A = 25\text{ °C}$                       | $\epsilon_{SL25}$                   | % of $I_{PN}$                 | -1.25  |                      | 1.25  |                                                  |
| Electrical offset voltage referred to primary                                       | $U_{OE}$                            | mV                            | -5     |                      | 5     | $U_{out} - U_{Iref}$ @ $U_{Iref} = 2.5\text{ V}$ |
| Electrical offset current referred to primary                                       | $I_{OE}$                            | mA                            | -62.5  |                      | 62.5  |                                                  |
| Temperature coefficient of $S$                                                      | $TCS$                               | ppm/K                         | -200   |                      | 200   | -40 °C ... 125 °C                                |
| Temperature coefficient of $U_{Iref}$                                               | $TCU_{Iref}$                        | ppm/K                         | -150   |                      | 150   | -40 °C ... 125 °C                                |
| Temperature coefficient of $U_{OE}$                                                 | $TCU_{OE}$                          | mV/K                          | -0.075 |                      | 0.075 | -40 °C ... 125 °C                                |
| Temperature coefficient of $I_{OE}$ referred to primary                             | $TCI_{OE}$                          | mA/K                          | -0.94  |                      | 0.94  | -40 °C ... 125 °C                                |
| Magnetic offset current after overload ( $I_p > 500\text{ A}$ ) referred to primary | $I_{OM}$                            | A                             |        | 0.18                 |       |                                                  |
| Noise voltage spectral density referred to primary                                  | $u_{no}$                            | $\mu\text{V}/\text{Hz}^{1/2}$ |        | 8.6                  |       | 100 Hz ... 100 kHz                               |
| Internal OCD detection threshold                                                    | $I_{I\text{OCD Th}}$                | A                             |        | $2.75 \times I_{PN}$ |       | 25 °C ... 125 °C                                 |
| Internal OCD threshold error                                                        | $\epsilon_{I\text{OCD Th}}$         | %                             |        | $\pm 10$             |       | Referred to $I_{PN}$                             |
| Internal OCD output on resistance                                                   | $R_{on\text{I}\text{OCD}}$          | $\Omega$                      | 70     | 95                   | 100   | Open drain output, active low                    |
| Linearity error 0 ... $\pm I_{PN}$                                                  | $\epsilon_L$                        | %                             | -0.5   |                      | 0.5   | Referred to $I_{PN}$                             |
| Linearity error 0 ... $\pm I_{PM}$                                                  | $\epsilon_L$                        | %                             | -0.5   |                      | 0.5   | Referred to $I_{PM}$                             |
| Delay time @ 10 % of $I_{PN}$                                                       | $t_{D10}$                           | $\mu\text{s}$                 |        |                      | 1.5   |                                                  |
| Delay time @ 90 % of $I_{PN}$                                                       | $t_{D90}$                           | $\mu\text{s}$                 |        |                      | 2     |                                                  |
| Internal OCD delay time                                                             | $t_{D\text{I}\text{OCD}}$           | $\mu\text{s}$                 | 1.4    | 1.7                  | 2.1   |                                                  |
| Frequency bandwidth (-3 dB)                                                         | $BW$                                | kHz                           |        | 300                  |       |                                                  |
| Internal OCD output hold time                                                       | $t_{\text{hold}\text{I}\text{OCD}}$ | $\mu\text{s}$                 | 7      | 10                   | 14    |                                                  |

**Electrical data HMSR 15-SMS**

At  $T_A = 25\text{ °C}$ ,  $U_C = 5\text{ V}$ ,  $R_L = 10\text{ k}\Omega$ , unless otherwise noted (see Min, Max, typ, definition paragraph in page 11).

| Parameter                                                                           | Symbol                        | Unit                          | Min    | Typ                  | Max   | Comment                                          |
|-------------------------------------------------------------------------------------|-------------------------------|-------------------------------|--------|----------------------|-------|--------------------------------------------------|
| Primary nominal current                                                             | $I_{PN}$                      | A                             |        | 15                   |       |                                                  |
| Primary current, measuring range                                                    | $I_{PM}$                      | A                             | -37.5  |                      | 37.5  | With $\pm U_C \geq 4.6\text{ V}$                 |
| Internal reference voltage @ $I_P = 0\text{ A}$                                     | $U_{Iref}$                    | V                             | 2.48   | 2.5                  | 2.52  |                                                  |
| Output voltage range @ $I_{PM}$                                                     | $U_{out} - U_{ref}$           | V                             | -2     |                      | 2     |                                                  |
| Output Internal resistance of $U_{out}$                                             | $R_{out}$                     | $\Omega$                      |        | 2                    | 5     |                                                  |
| Output Internal resistance of $U_{ref}$                                             | $R_{ref}$                     | $\Omega$                      | 120    | 200                  | 333   |                                                  |
| Load capacitance on $U_{out}$                                                       | $C_L$                         | nF                            | 0      | 4.7                  | 6     |                                                  |
| Load capacitance on $U_{ref}$                                                       | $C_L$                         | nF                            | 0      | 47                   | 100   |                                                  |
| DC supply voltage =                                                                 | $U_C$                         | V                             | 4.5    | 5                    | 5.5   |                                                  |
| DC current consumption =                                                            | $I_C$                         | mA                            |        | 20                   | 26    |                                                  |
| Nominal sensitivity                                                                 | $S_N$                         | mV/A                          |        | 53.33                |       | 800 mV @ $I_{PN}$                                |
| Sensitivity error                                                                   | $\varepsilon_S$               | %                             | -0.75  |                      | 0.75  | Factory adjustment                               |
| Sum of sensitivity and linearity error @ $T_A = 25\text{ °C}$                       | $\varepsilon_{SL25}$          | % of $I_{PN}$                 | -1.25  |                      | 1.25  |                                                  |
| Electrical offset voltage referred to primary                                       | $U_{OE}$                      | mV                            | -5     |                      | 5     | $U_{out} - U_{Iref}$ @ $U_{Iref} = 2.5\text{ V}$ |
| Electrical offset current referred to primary                                       | $I_{OE}$                      | mA                            | -93.75 |                      | 93.75 |                                                  |
| Temperature coefficient of $S$                                                      | $TCS$                         | ppm/K                         | -200   |                      | 200   | -40 °C ... 125 °C                                |
| Temperature coefficient of $U_{Iref}$                                               | $TCU_{Iref}$                  | ppm/K                         | -150   |                      | 150   | -40 °C ... 125 °C                                |
| Temperature coefficient of $U_{OE}$                                                 | $TCU_{OE}$                    | mV/K                          | -0.075 |                      | 0.075 | -40 °C ... 125 °C                                |
| Temperature coefficient of $I_{OE}$ referred to primary                             | $TCI_{OE}$                    | mA/K                          | -1.41  |                      | 1.41  | -40 °C ... 125 °C                                |
| Magnetic offset current after overload ( $I_P > 500\text{ A}$ ) referred to primary | $I_{OM}$                      | A                             |        | 0.18                 |       |                                                  |
| Noise voltage spectral density referred to primary                                  | $u_{no}$                      | $\mu\text{V}/\text{Hz}^{1/2}$ |        | 6.3                  |       | 100 Hz ... 100 kHz                               |
| Internal OCD detection threshold                                                    | $I_{I\text{OCD}Th}$           | A                             |        | $2.75 \times I_{PN}$ |       | 25 °C ... 125 °C                                 |
| Internal OCD threshold error                                                        | $\varepsilon_{I\text{OCD}Th}$ | %                             |        | $\pm 10$             |       | Referred to $I_{PN}$                             |
| Internal OCD output on resistance                                                   | $R_{on\text{I}OCD}$           | $\Omega$                      | 70     | 95                   | 100   | Open drain output, active low                    |
| Linearity error 0 ... $\pm I_{PN}$                                                  | $\varepsilon_L$               | %                             | -0.5   |                      | 0.5   | Referred to $I_{PN}$                             |
| Linearity error 0 ... $\pm I_{PM}$                                                  | $\varepsilon_L$               | %                             | -0.5   |                      | 0.5   | Referred to $I_{PM}$                             |
| Delay time @ 10 % of $I_{PN}$                                                       | $t_{D10}$                     | $\mu\text{s}$                 |        |                      | 1.5   |                                                  |
| Delay time @ 90 % of $I_{PN}$                                                       | $t_{D90}$                     | $\mu\text{s}$                 |        |                      | 2     |                                                  |
| Internal OCD delay time                                                             | $t_{D\text{I}OCD}$            | $\mu\text{s}$                 | 1.4    | 1.7                  | 2.1   |                                                  |
| Frequency bandwidth (-3 dB)                                                         | $BW$                          | kHz                           |        | 300                  |       |                                                  |
| Internal OCD output hold time                                                       | $t_{hold\text{I}OCD}$         | $\mu\text{s}$                 | 7      | 10                   | 14    |                                                  |



**Electrical data HMSR 20-SMS**

At  $T_A = 25\text{ °C}$ ,  $U_C = 5\text{ V}$ ,  $R_L = 10\text{ k}\Omega$ , unless otherwise noted (see Min, Max, typ, definition paragraph in page 11).

| Parameter                                                                           | Symbol                         | Unit                          | Min    | Typ                  | Max   | Comment                                          |
|-------------------------------------------------------------------------------------|--------------------------------|-------------------------------|--------|----------------------|-------|--------------------------------------------------|
| Primary nominal current                                                             | $I_{PN}$                       | A                             |        | 20                   |       |                                                  |
| Primary current, measuring range                                                    | $I_{PM}$                       | A                             | -50    |                      | 50    | With $\pm U_C \geq 4.6\text{ V}$                 |
| Internal reference voltage @ $I_P = 0\text{ A}$                                     | $U_{Iref}$                     | V                             | 2.48   | 2.5                  | 2.52  |                                                  |
| Output voltage range @ $I_{PM}$                                                     | $U_{out} - U_{ref}$            | V                             | -2     |                      | 2     |                                                  |
| Output Internal resistance of $U_{out}$                                             | $R_{out}$                      | $\Omega$                      |        | 2                    | 5     |                                                  |
| Output Internal resistance of $U_{ref}$                                             | $R_{ref}$                      | $\Omega$                      | 120    | 200                  | 333   |                                                  |
| Load capacitance on $U_{out}$                                                       | $C_L$                          | nF                            | 0      | 4.7                  | 6     |                                                  |
| Load capacitance on $U_{ref}$                                                       | $C_L$                          | nF                            | 0      | 47                   | 100   |                                                  |
| DC supply voltage =                                                                 | $U_C$                          | V                             | 4.5    | 5                    | 5.5   |                                                  |
| DC current consumption =                                                            | $I_C$                          | mA                            |        | 20                   | 26    |                                                  |
| Nominal sensitivity                                                                 | $S_N$                          | mV/A                          |        | 40                   |       | 800 mV @ $I_{PN}$                                |
| Sensitivity error                                                                   | $\varepsilon_S$                | %                             | -0.75  |                      | 0.75  | Factory adjustment                               |
| Sum of sensitivity and linearity error @ $T_A = 25\text{ °C}$                       | $\varepsilon_{SL25}$           | % of $I_{PN}$                 | -1.25  |                      | 1.25  |                                                  |
| Electrical offset voltage referred to primary                                       | $U_{OE}$                       | mV                            | -5     |                      | 5     | $U_{out} - U_{Iref}$ @ $U_{Iref} = 2.5\text{ V}$ |
| Electrical offset current referred to primary                                       | $I_{OE}$                       | mA                            | -125   |                      | 125   |                                                  |
| Temperature coefficient of $S$                                                      | $TCS$                          | ppm/K                         | -200   |                      | 200   | -40 °C ... 125 °C                                |
| Temperature coefficient of $U_{Iref}$                                               | $TCU_{Iref}$                   | ppm/K                         | -150   |                      | 150   | -40 °C ... 125 °C                                |
| Temperature coefficient of $U_{OE}$                                                 | $TCU_{OE}$                     | mV/K                          | -0.075 |                      | 0.075 | -40 °C ... 125 °C                                |
| Temperature coefficient of $I_{OE}$ referred to primary                             | $TCI_{OE}$                     | mA/K                          | -1.88  |                      | 1.88  | -40 °C ... 125 °C                                |
| Magnetic offset current after overload ( $I_p > 500\text{ A}$ ) referred to primary | $I_{OM}$                       | A                             |        | 0.18                 |       |                                                  |
| Noise voltage spectral density referred to primary                                  | $u_{no}$                       | $\mu\text{V}/\text{Hz}^{1/2}$ |        | 4.5                  |       | 100 Hz ... 100 kHz                               |
| Internal OCD detection threshold                                                    | $I_{I\text{OCD Th}}$           | A                             |        | $2.75 \times I_{PN}$ |       | 25 °C ... 125 °C                                 |
| Internal OCD threshold error                                                        | $\varepsilon_{I\text{OCD Th}}$ | %                             |        | $\pm 10$             |       | Referred to $I_{PN}$                             |
| Internal OCD output on resistance                                                   | $R_{on\text{I OCD}}$           | $\Omega$                      | 70     | 95                   | 100   | Open drain output, active low                    |
| Linearity error 0 ... $\pm I_{PN}$                                                  | $\varepsilon_L$                | %                             | -0.5   |                      | 0.5   | Referred to $I_{PN}$                             |
| Linearity error 0 ... $\pm I_{PM}$                                                  | $\varepsilon_L$                | %                             | -0.5   |                      | 0.5   | Referred to $I_{PM}$                             |
| Delay time @ 10 % of $I_{PN}$                                                       | $t_{D10}$                      | $\mu\text{s}$                 |        |                      | 1.5   |                                                  |
| Delay time @ 90 % of $I_{PN}$                                                       | $t_{D90}$                      | $\mu\text{s}$                 |        |                      | 2     |                                                  |
| Internal OCD delay time                                                             | $t_{D\text{I OCD}}$            | $\mu\text{s}$                 | 1.4    | 1.7                  | 2.1   |                                                  |
| Frequency bandwidth (-3 dB)                                                         | $BW$                           | kHz                           |        | 300                  |       |                                                  |
| Internal OCD output hold time                                                       | $t_{\text{hold I OCD}}$        | $\mu\text{s}$                 | 7      | 10                   | 14    |                                                  |

**Electrical data HMSR 30-SMS**

At  $T_A = 25\text{ °C}$ ,  $U_C = 5\text{ V}$ ,  $R_L = 10\text{ k}\Omega$ , unless otherwise noted (see Min, Max, typ, definition paragraph in page 11).

| Parameter                                                                           | Symbol                        | Unit                          | Min    | Typ                  | Max   | Comment                                                               |
|-------------------------------------------------------------------------------------|-------------------------------|-------------------------------|--------|----------------------|-------|-----------------------------------------------------------------------|
| Primary nominal current                                                             | $I_{PN}$                      | A                             |        | 30                   |       |                                                                       |
| Primary current, measuring range                                                    | $I_{PM}$                      | A                             | -75    |                      | 75    | With $\pm U_C \geq 4.6\text{ V}$ , $T_A < 75\text{ °C}$ <sup>1)</sup> |
| Internal reference voltage @ $I_P = 0\text{ A}$                                     | $U_{Iref}$                    | V                             | 2.48   | 2.5                  | 2.52  |                                                                       |
| Output voltage range @ $I_{PM}$                                                     | $U_{out} - U_{ref}$           | V                             | -2     |                      | 2     |                                                                       |
| Output Internal resistance of $U_{out}$                                             | $R_{out}$                     | $\Omega$                      |        | 2                    | 5     |                                                                       |
| Output Internal resistance of $U_{ref}$                                             | $R_{ref}$                     | $\Omega$                      | 120    | 200                  | 333   |                                                                       |
| Load capacitance on $U_{out}$                                                       | $C_L$                         | nF                            | 0      | 4.7                  | 6     |                                                                       |
| Load capacitance on $U_{ref}$                                                       | $C_L$                         | nF                            | 0      | 47                   | 100   |                                                                       |
| DC supply voltage =                                                                 | $U_C$                         | V                             | 4.5    | 5                    | 5.5   |                                                                       |
| DC current consumption =                                                            | $I_C$                         | mA                            |        | 20                   | 26    |                                                                       |
| Nominal sensitivity                                                                 | $S_N$                         | mV/A                          |        | 26.67                |       | 800 mV @ $I_{PN}$                                                     |
| Sensitivity error                                                                   | $\varepsilon_S$               | %                             | -0.75  |                      | 0.75  | Factory adjustment                                                    |
| Sum of sensitivity and linearity error @ $T_A = 25\text{ °C}$                       | $\varepsilon_{SL25}$          | % of $I_{PN}$                 | -1.25  |                      | 1.25  |                                                                       |
| Electrical offset voltage referred to primary                                       | $U_{OE}$                      | mV                            | -5     |                      | 5     | $U_{out} - U_{Iref}$ @ $U_{Iref} = 2.5\text{ V}$                      |
| Electrical offset current referred to primary                                       | $I_{OE}$                      | mA                            | -187.5 |                      | 187.5 |                                                                       |
| Temperature coefficient of $S$                                                      | $TCS$                         | ppm/K                         | -200   |                      | 200   | -40 °C ... 125 °C                                                     |
| Temperature coefficient of $U_{Iref}$                                               | $TCU_{Iref}$                  | ppm/K                         | -150   |                      | 150   | -40 °C ... 125 °C                                                     |
| Temperature coefficient of $U_{OE}$                                                 | $TCU_{OE}$                    | mV/K                          | -0.075 |                      | 0.075 | -40 °C ... 125 °C                                                     |
| Temperature coefficient of $I_{OE}$ referred to primary                             | $TCI_{OE}$                    | mA/K                          | -2.81  |                      | 2.81  | -40 °C ... 125 °C                                                     |
| Magnetic offset current after overload ( $I_p > 500\text{ A}$ ) referred to primary | $I_{OM}$                      | A                             |        | 0.18                 |       |                                                                       |
| Noise voltage spectral density referred to primary                                  | $u_{no}$                      | $\mu\text{V}/\text{Hz}^{1/2}$ |        | 3.2                  |       | 100 Hz ... 100 kHz                                                    |
| Internal OCD detection threshold                                                    | $I_{I\text{OCD}Th}$           | A                             |        | $2.75 \times I_{PN}$ |       | 25 °C ... 125 °C                                                      |
| Internal OCD threshold error                                                        | $\varepsilon_{I\text{OCD}Th}$ | %                             |        | $\pm 10$             |       | Referred to $I_{PN}$                                                  |
| Internal OCD output on resistance                                                   | $R_{on\text{I}OCD}$           | $\Omega$                      | 70     | 95                   | 100   | Open drain output, active low                                         |
| Linearity error 0 ... $\pm I_{PN}$                                                  | $\varepsilon_L$               | %                             | -0.5   |                      | 0.5   | Referred to $I_{PN}$                                                  |
| Linearity error 0 ... $\pm I_{PM}$                                                  | $\varepsilon_L$               | %                             | -0.5   |                      | 0.5   | Referred to $I_{PM}$                                                  |
| Delay time @ 10 % of $I_{PN}$                                                       | $t_{D10}$                     | $\mu\text{s}$                 |        |                      | 1.5   |                                                                       |
| Delay time @ 90 % of $I_{PN}$                                                       | $t_{D90}$                     | $\mu\text{s}$                 |        |                      | 2     |                                                                       |
| Internal OCD delay time                                                             | $t_{D\text{I}OCD}$            | $\mu\text{s}$                 | 1.4    | 1.7                  | 2.1   |                                                                       |
| Frequency bandwidth (-3 dB)                                                         | $BW$                          | kHz                           |        | 300                  |       |                                                                       |
| Internal OCD output hold time                                                       | $t_{hold\text{I}OCD}$         | $\mu\text{s}$                 | 7      | 10                   | 14    |                                                                       |

Note: <sup>1)</sup> See figure 2.

### Sum of sensitivity and linearity error

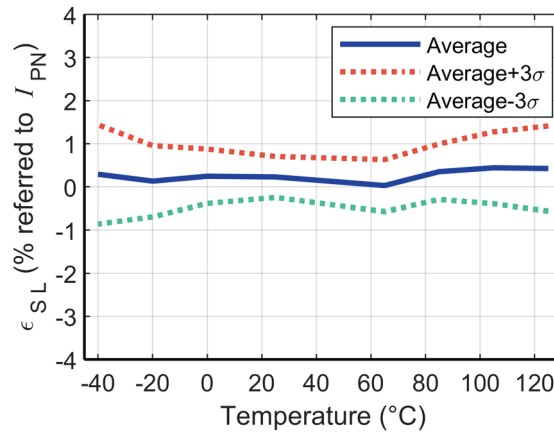

Figure 1: Typical value on HMSR 20-SMS (40 parts)

### Measuring range vs ambient temperature

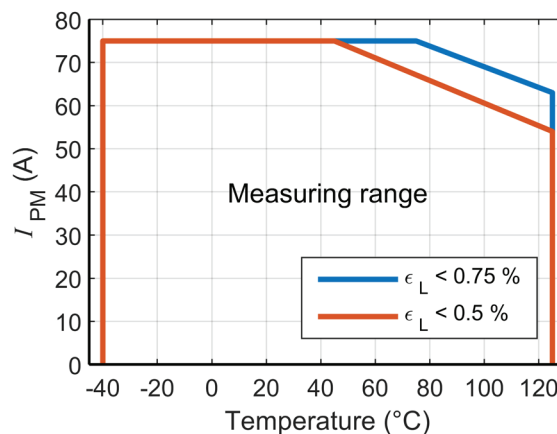

Figure 2

### Definition of typical, minimum and maximum values

Minimum and maximum values for specified limiting and safety conditions have to be understood as such as well as values shown in “typical” graphs.

On the other hand, measured values are part of a statistical distribution that can be specified by an interval with upper and lower limits and a probability for measured values to lie within this interval.

Unless otherwise stated (e.g. “100 % tested”), the LEM definition for such intervals designated with “min” and “max” is that the probability for values of samples to lie in this interval is 99.73 %.

For a normal (Gaussian) distribution, this corresponds to an interval between  $-3\sigma$  and  $+3\sigma$ . If “typical” values are not obviously mean or average values, those values are defined to delimit intervals with a probability of 68.27 %, corresponding to an interval between  $-\sigma$  and  $+\sigma$  for a normal distribution.

Typical, maximal and minimal values are determined during the initial characterization of the product.

External overcurrent detection

| Parameter                                   | Symbol                       | Unit          | Specification |         |     | Conditions                           |
|---------------------------------------------|------------------------------|---------------|---------------|---------|-----|--------------------------------------|
|                                             |                              |               | Min           | Typical | Max |                                      |
| External OCD voltage                        | $U_{E\text{OCD}}$            | V             | 0.3           |         | 2.5 |                                      |
| External OCD output on resistance to ground | $R_{\text{on}E\text{OCD}}$   | $\Omega$      | 35            | 200     | 300 | Open drain output, active low        |
| External OCD delay time                     | $t_{D\text{E}\text{OCD}}$    | $\mu\text{s}$ | 7             | 10      | 13  | To be added to the sensor delay time |
| External OCD output hold time               | $t_{\text{hold}E\text{OCD}}$ | $\mu\text{s}$ | 7             | 10      | 14  |                                      |
| External OCD threshold error                | $\varepsilon_{E\text{OCD}}$  | %             |               | $\pm 6$ |     | Referred to $I_{PN}$                 |

$I_{E\text{OCD}}$ : External overcurrent detection (OCD threshold) at  $U_{\text{ref}} = 2.5\text{ V}$

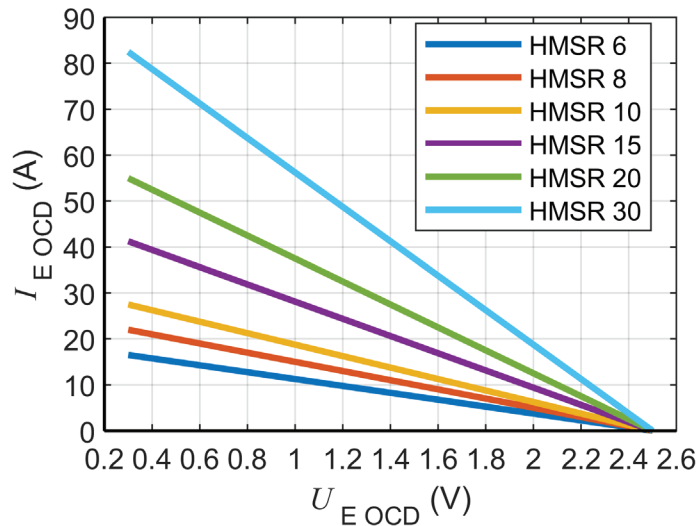

Figure 3

$$I_{E\text{OCD}} = \frac{U_{\text{ref}} - U_{E\text{OCD}}}{S_N} \quad U_{E\text{OCD}} = \frac{R_E}{R_E + R_{\text{ref}}} \times U_{\text{ref}} \quad \text{with } 0.3 \leq U_{E\text{OCD}} \leq U_{\text{ref}}$$

Pins definition

| Pins number | Name       | Description                             |
|-------------|------------|-----------------------------------------|
| 1           | $I_p^+$    | Input of the primary current            |
| 8           | $I_p^-$    | Output of the primary current           |
| 9           | OCD INT    | Internal OCD                            |
| 10          | $U_c$      | Supply voltage                          |
| 11          | $U_{ref}$  | Reference voltage                       |
| 12          | $U_{out}$  | Output voltage                          |
| 13          | NC         | No internal connection                  |
| 14          | OCD EXT    | External OCD terminal                   |
| 15          | GND        | Ground terminal                         |
| 16          | $U_{EOCD}$ | External OCD threshold voltage terminal |

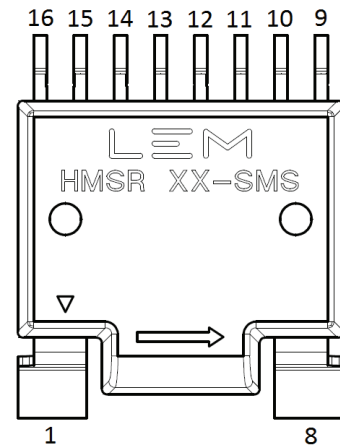

Figure 4

Block diagram

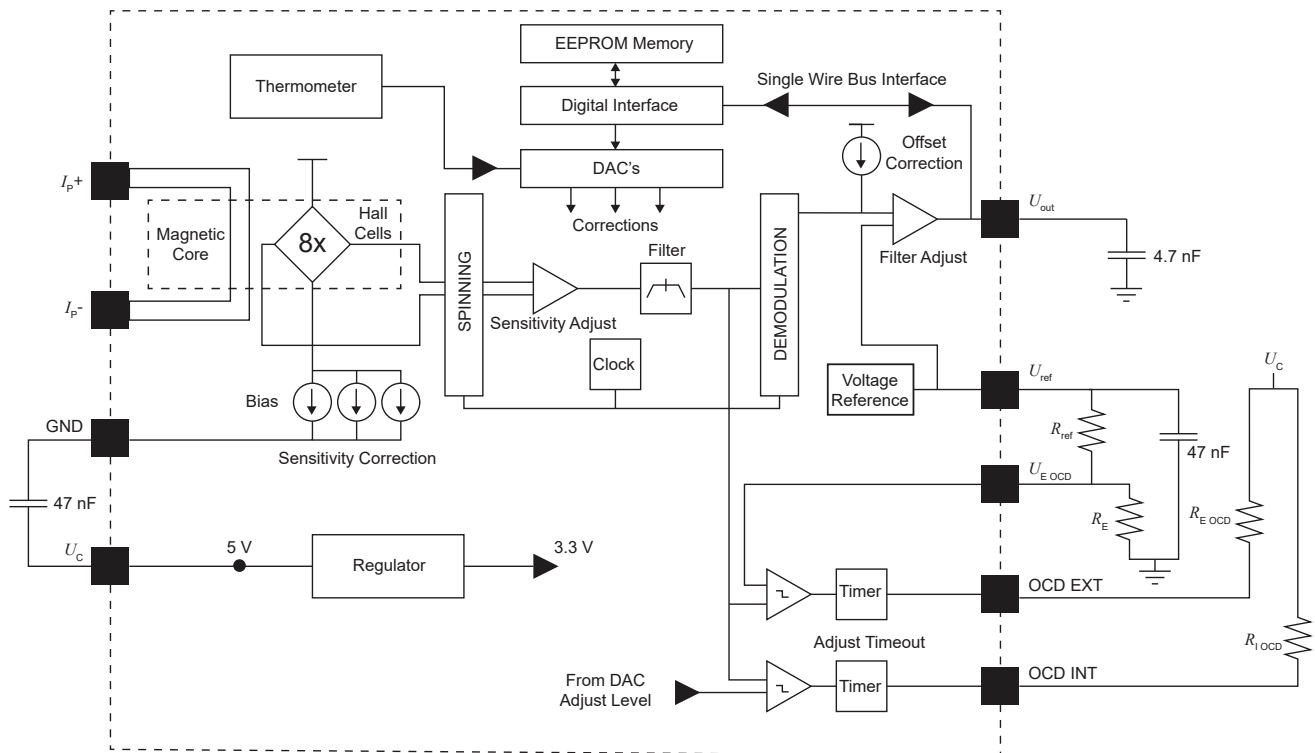

Figure 5

**Total error referred to primary**

The total error  $\epsilon_{tot}$  is the error at  $\pm I_{PN}$ , relative to the rated value  $I_{PN}$ .

It includes all errors mentioned above

- the electrical offset  $I_{OE}$
- the magnetic offset  $I_{OM}$
- the sensitivity error  $\epsilon_s$
- the linearity error  $\epsilon_L$  (to  $I_{PN}$ ).

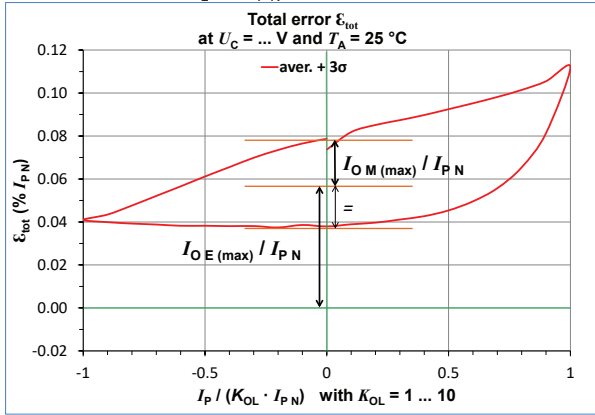

Figure 6: Total error  $\epsilon_{tot}$

**Electrical offset referred to primary**

Using the current cycle shown in figure 7, the electrical offset current  $I_{OE}$  is the residual output referred to primary when the input current is zero.

**Magnetic offset referred to primary**

$$I_{OE} = \frac{I_{P(3)} + I_{P(5)}}{2}$$

The magnetic offset current  $I_{OM}$  is the consequence of a current on the primary side ("memory effect" of the transducer's ferromagnetic core). It is measured using the following primary current cycle.  $I_{OM}$  depends on the current value  $I_P \geq I_{PN}$ .  $K_{OL}$ : Overload factor

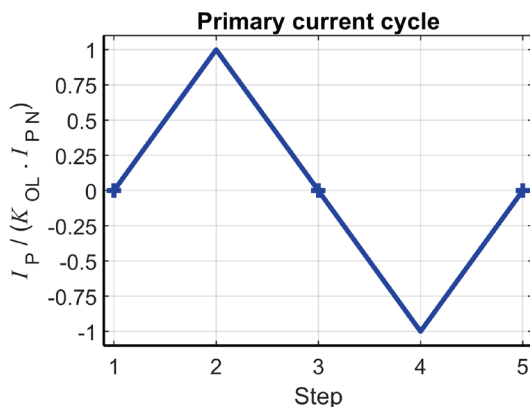

Figure 7: Current cycle used to measure magnetic and electrical offset (transducer supplied)

$$I_{OM} = \frac{I_{P(3)} - I_{P(5)}}{2}$$

**Sensitivity and linearity**

To measure sensitivity and linearity, the primary current (DC) is cycled from 0 to  $I_P$ , then to  $-I_P$  and back to 0 (equally spaced  $I_{PN}/10$  steps). The sensitivity  $S$  is defined as the slope of the linear regression line for a cycle between  $\pm I_{PN}$ .

The linearity error  $\epsilon_L$  is the maximum positive or negative difference between the measured points and the linear regression line, expressed in % of  $I_{PN}$ .

**Delay times**

The delay time  $t_{D,10}$  @ 10 % and the delay time  $t_{D,90}$  @ 90 % with respect to the primary are shown in the next figure.

Both slightly depend on the primary current  $di/dt$ . They are measured at nominal current.

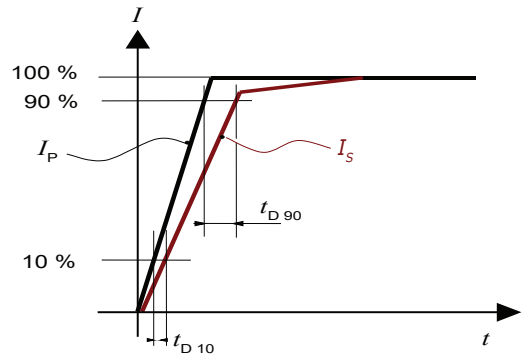

Figure 8:  $t_{D,10}$  (delay time @ 10 %) and  $t_{D,90}$  (delay time @ 90 %).

PCB footprint (in mm)

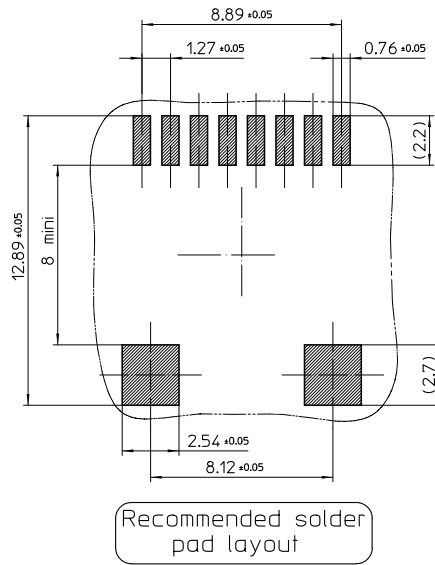

Figure 9

Soldering on PCB

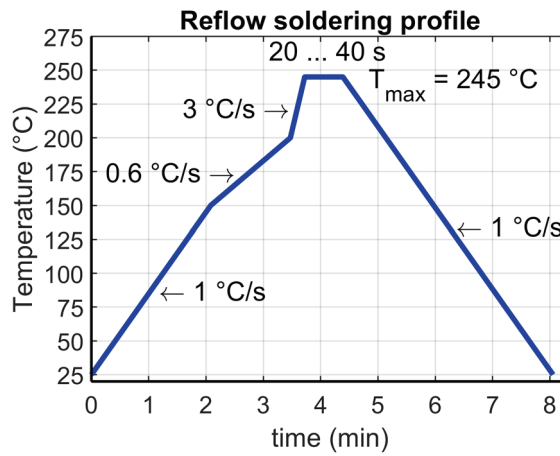
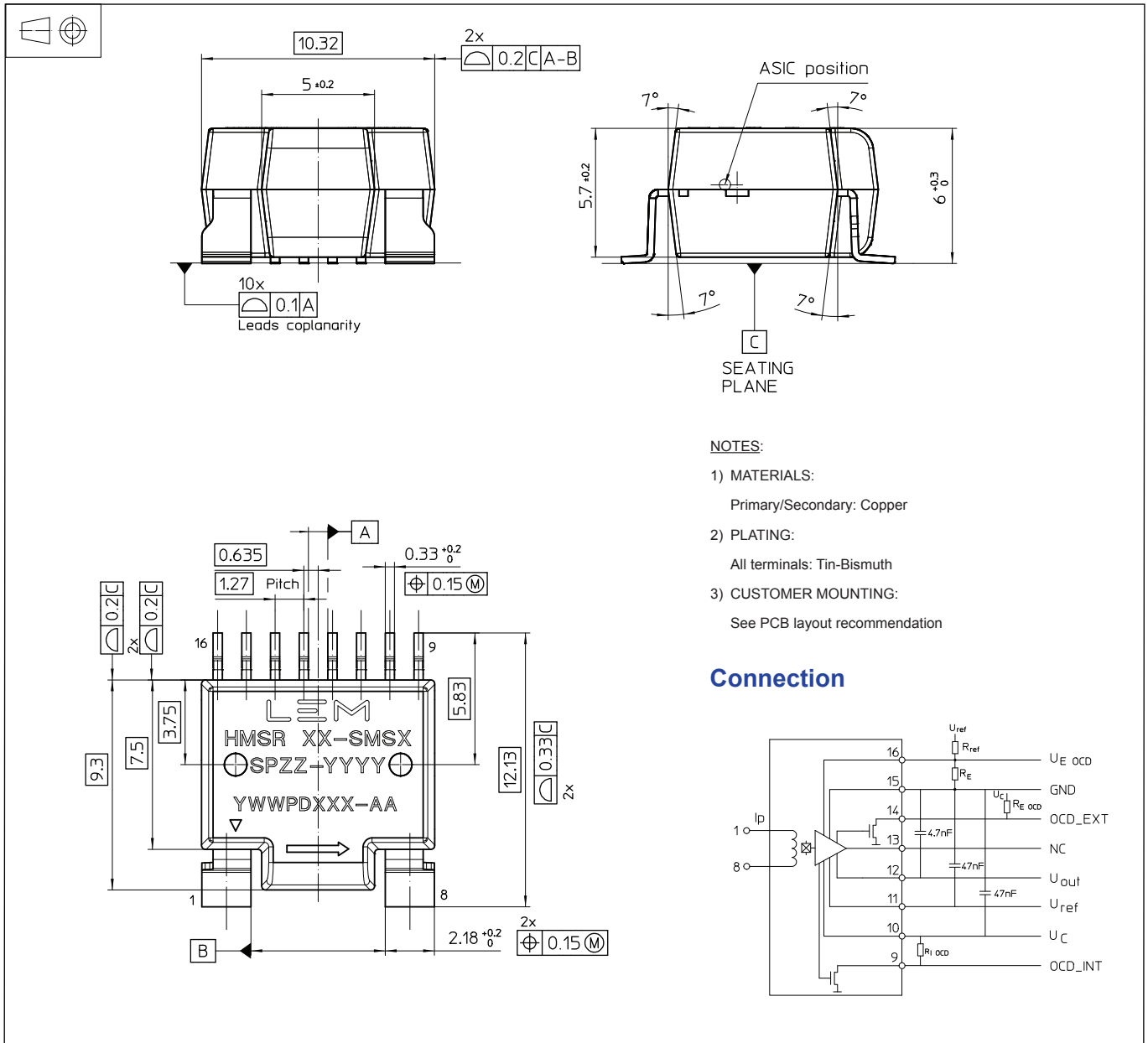

Figure 10

Soldering remarks:

- Per JEDEC J-STD-020E for packages more than 2.5 mm thick per table 4.2 (Pb-Free Process) of the specification.
- Best practice is to use 7 zones or greater conventional reflow system, limiting the time at reflow temperature as indicated in profile above.
- Rework not recommended.

**Dimensions (in mm)**

**Mechanical characteristics**

- General tolerance  $\pm 0.15$  mm

**Remark**

- $U_{out} - U_{ref}$  is positive when  $I_p$  flows in the direction of arrow (pin 1 to pin 8).



Tape and Reel (in mm)

