

Power relays (Over 2 A)
DW RELAYS

Product Catalog

**IN Your
Future**

DW RELAYS

1 Form A 8 A/16 A, Small, Polarized power relays (latching type)

Protective construction : Flux-resistant type

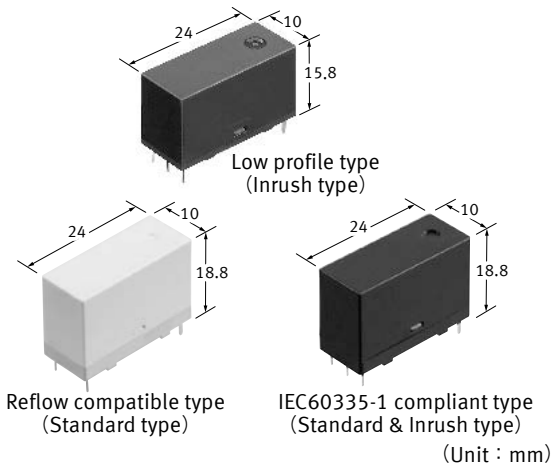

FEATURES

- Low profile type available (height: 15.8 mm)
- Reflow possible (Pin-in-Paste)
- Conforms to various safety standards (UL/C-UL, VDE, CQC)
- Inrush type available, TV-8 rating (UL/C-UL approved)
- IEC60335-1* compliant type available, PTI 325V (VDE approved)
 - * Common safety standard for major electrical appliance
- Compliant with IEC62368-1* (VDE approved)
 - * Audio/video, information and communication technology equipment - Part 1: Safety requirements

TYPICAL APPLICATIONS

- Smart meters
- Home appliances
- Various power supplies
- Lighting control equipment
- Industrial equipment
- Security equipment

ORDERING INFORMATION (PART NO.)

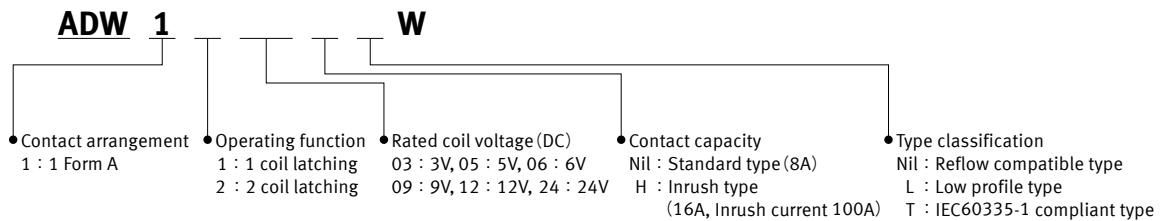

- Notes :
1. "L" and "T" type are non-compliant reflow soldering.
 2. Low profile type is available (inrush type only).
 3. The suffix "W" on the part number is only displayed on the inner and outer packaging. It is not displayed on the relay.
 4. 5A 277V AC (Inrush current 320A) compliant with Electronic ballast is also available.
 5. Inrush type (20A) is also available.

Power relays (Over 2 A) DW RELAYS

TYPES

■ Standard type (8 A)

● Reflow compatible type

Contact arrangement	Rated coil voltage	Part No.		Standard packing	
		1 coil latching	2 coil latching	Inner carton	Outer carton
1 Form A	3 V DC	ADW1103W	ADW1203W	100 pcs.	500 pcs.
	5 V DC	ADW1105W	ADW1205W		
	6 V DC	ADW1106W	ADW1206W		
	9 V DC	ADW1109W	ADW1209W		
	12 V DC	ADW1112W	ADW1212W		
	24 V DC	ADW1124W	ADW1224W		

Note: Carton packing is standard. Tube packing type is also available. Please consult us for details.

● IEC60335-1 compliant type

Contact arrangement	Rated coil voltage	Part No.		Standard packing	
		1 coil latching	2 coil latching	Inner carton	Outer carton
1 Form A	3 V DC	ADW1103TW	ADW1203TW	100 pcs.	500 pcs.
	5 V DC	ADW1105TW	ADW1205TW		
	6 V DC	ADW1106TW	ADW1206TW		
	9 V DC	ADW1109TW	ADW1209TW		
	12 V DC	ADW1112TW	ADW1212TW		
	24 V DC	ADW1124TW	ADW1224TW		

Note: Carton packing is standard. Tube packing type is also available. Please consult us for details.

■ Inrush type (16 A)

● Inrush current 100 A, IEC60335-1 compliant type

Contact arrangement	Rated coil voltage	Part No.		Standard packing	
		1 coil latching	2 coil latching	Inner carton	Outer carton
1 Form A	3 V DC	ADW1103HTW	ADW1203HTW	100 pcs.	500 pcs.
	5 V DC	ADW1105HTW	ADW1205HTW		
	6 V DC	ADW1106HTW	ADW1206HTW		
	9 V DC	ADW1109HTW	ADW1209HTW		
	12 V DC	ADW1112HTW	ADW1212HTW		
	24 V DC	ADW1124HTW	ADW1224HTW		

Notes: 1. Carton packing is standard. Tube packing type is also available. Please consult us for details.
2. Please consult us for the reflow compatible type of inrush type.

● Inrush current 100 A, low profile type

Contact arrangement	Rated coil voltage	Part No.		Standard packing	
		1 coil latching	2 coil latching	Inner carton	Outer carton
1 Form A	3 V DC	ADW1103HLW	ADW1203HLW	100 pcs.	500 pcs.
	5 V DC	ADW1105HLW	ADW1205HLW		
	6 V DC	ADW1106HLW	ADW1206HLW		
	9 V DC	ADW1109HLW	ADW1209HLW		
	12 V DC	ADW1112HLW	ADW1212HLW		
	24 V DC	ADW1124HLW	ADW1224HLW		

Note: Carton packing is standard.

■ Compliant with Electronic ballast

Please contact our sales representative for 5 A 277 V AC (Inrush current 320A) compliant with Electronic ballast.

Power relays (Over 2 A) DW RELAYS

RATING

■ Coil data

- Operating characteristics such as 'Operate voltage' and 'Release voltage' are influenced by mounting conditions, ambient temperature, etc.

Therefore, please use the relay within $\pm 5\%$ of rated coil voltage.

- 'Initial' means the condition of products at the time of delivery.

● 1 coil latching

Rated coil voltage	Set voltage* (at 20°C)	Reset voltage* (at 20°C)	Rated operating current ($\pm 10\%$, at 20°C)	Coil resistance ($\pm 10\%$, at 20°C)	Rated operating power	Max. allowable voltage (at 20°C)
3 V DC	Max. 80% V of rated coil voltage (Initial)	Max. 80% V of rated coil voltage (Initial)	66.7 mA	45 Ω	200 mW	110% V of rated coil voltage
5 V DC			40 mA	125 Ω		
6 V DC			33.3 mA	180 Ω		
9 V DC			22.2 mA	405 Ω		
12 V DC			16.7 mA	720 Ω		
24 V DC			8.3 mA	2,880 Ω		

*square, pulse drive

● 2 coil latching

Rated coil voltage	Set voltage* (at 20°C)	Reset voltage* (at 20°C)	Rated operating current ($\pm 10\%$, at 20°C)		Coil resistance ($\pm 10\%$, at 20°C)		Rated operating power		Max. allowable voltage (at 20°C)
			Set coil	Reset coil	Set coil	Reset coil	Set coil	Reset coil	
3 V DC	Max. 80% V of rated coil voltage (Initial)	Max. 80% V of rated coil voltage (Initial)	133.3 mA	133.3 mA	22.5 Ω	22.5 Ω	400 mW	400 mW	110% V of rated coil voltage
5 V DC			80 mA	80 mA	62.5 Ω	62.5 Ω			
6 V DC			66.7 mA	66.7 mA	90 Ω	90 Ω			
9 V DC			44.4 mA	44.4 mA	202.5 Ω	202.5 Ω			
12 V DC			33.3 mA	33.3 mA	360 Ω	360 Ω			
24 V DC			16.7 mA	16.7 mA	1,440 Ω	1,440 Ω			

*square, pulse drive

Power relays (Over 2 A) DW RELAYS

■ Specifications

Item		Specifications	
		Standard type (8 A)	Inrush type (16 A)
Contact data	Contact arrangement	1 Form A	
	Contact resistance (initial)	Max. 100 mΩ (by voltage drop 6 V DC 1 A)	
	Contact material	AgSnO ₂ type	
	Contact rating (resistive)	8 A 250 V AC	16 A 277 V AC
	Max. switching power (resistive)	2,000 VA	4,432 VA
	Max. switching voltage	250 V AC	277 V AC
	Max. switching current	8 A (AC)	16 A (AC)
	Min. switching load (reference value)*1	100 mA 5 V DC	
Insulation resistance (initial)		Min. 1,000 MΩ (at 500 V DC, Measured portion is the same as the case of dielectric strength.)	
Dielectric strength (initial)	Between open contacts	1,000 Vrms for 1 min (detection current: 10 mA)	
	Between contact and coil	5,000 Vrms for 1 min (detection current: 10 mA)	
Surge withstand voltage (initial)*2	Between contact and coil	12,000 V	
Time characteristics (initial)	Set time	Max. 15 ms at rated coil voltage (at 20°C, without bounce)	
	Reset time	Max. 15 ms at rated coil voltage (at 20°C, without bounce)	
Shock resistance	Functional	100 m/s ² (half-sine shock pulse: 11 ms, detection time: 10 μs)	
	Destructive	1,000 m/s ² (half-sine shock pulse: 6 ms)	
Vibration resistance	Functional	10 to 55 Hz (at double amplitude of 2 mm, detection time: 10 μs)	
	Destructive	10 to 55 Hz (at double amplitude of 3 mm)	
Expected life	Mechanical life	Min. 10 ⁶ ope. (switching frequency: at 180 times/min)	
Conditions	Conditions for usage, transport and storage*3	Ambient temperature: -40 to +85°C (-40 to +70°C at our standard packing condition) Humidity: 5 to 85% RH (Avoid icing and condensation)	Ambient temperature: -40 to +70°C (Over 8 A to 16 A) (-40 to +70°C at our standard packing condition), -40 to +85°C (Max. 8 A) Humidity: 5 to 85% RH (Avoid icing and condensation)
Unit weight		Approx. 8 g (Low profile type: Approx. 7.5 g)	

*1. This value can change due to the switching frequency, environmental conditions, and desired reliability level, therefore it is recommended to check this with the actual load.

*2. Wave is standard shock voltage of ±1.2×50 μs according to JEC-212-1981

*3. For ambient temperature, please read "GUIDELINES FOR RELAY USAGE".

■ Expected electrical life

Conditions: Switching frequency at 20 times/min

Type		Switching capacity	Number of operations
Standard type (8 A)	Resistive load: Type	8 A 250 V AC	Min. 50 x 10 ³ ope.
	Resistive load: IEC60335-1 compliant type	5 A 250 V AC	Min. 100 x 10 ³ ope.
Inrush type (16 A)	Resistive load	8 A 250 V AC	Min. 50 x 10 ³ ope.
		16 A 277 V AC	Min. 20 x 10 ³ ope. (switching frequency ON : OFF = 1 s : 5 s)
	Tungsten load	Inrush current 100 A 600 W 120 V AC	Min. 25 x 10 ³ ope. (switching frequency ON : OFF = 1 s : 59 s)

REFERENCE DATA

1. Max. switching capacity (AC Resistive load)

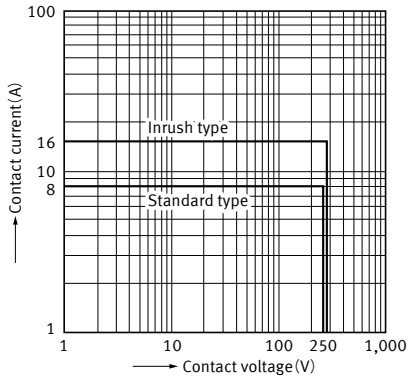

2. Ambient temperature characteristics (Standard type: Average)

Tested sample : ADW1106, 6 pcs.
Ambient temperature : -40 to +85°C

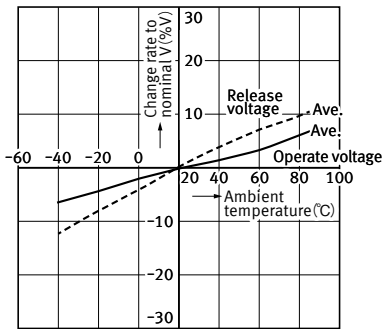

3-1. Set time (Standard type)

Tested sample : ADW1106, 15 pcs.
Ambient temperature : 28°C
Contact load : 5V DC, 10mA

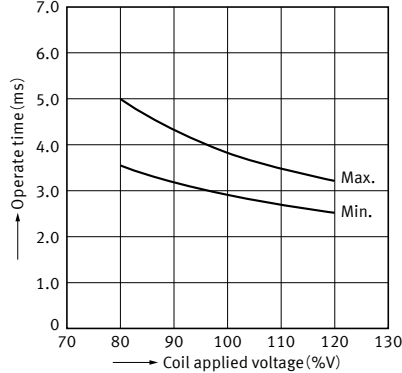

3-2. Reset time (Standard type)

Tested sample : ADW1106, 15 pcs.
Ambient temperature : 28°C
Contact load : 5V DC, 10mA

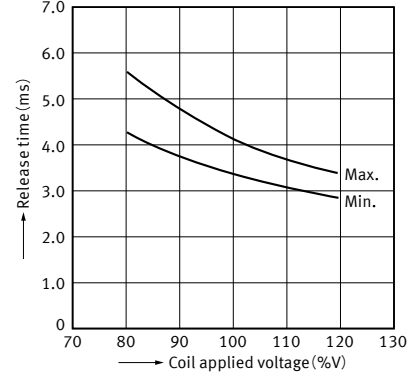

4. Ambient temperature characteristics (Inrush type: Average)

Tested sample : ADW1105HL, 6 pcs.
Ambient temperature : -40 to +85°C

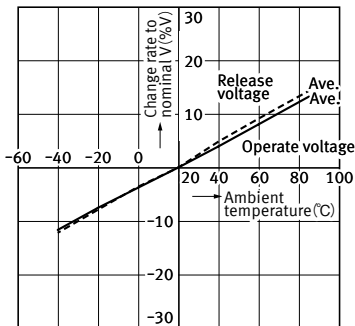

5-1. Set time (Inrush type)

Tested sample : ADW1112HL, 30 pcs.
Ambient temperature : 28°C
Contact load : 5V DC, 10mA

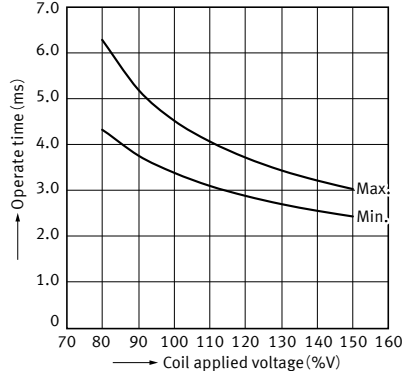

5-2. Reset time (Inrush type)

Tested sample : ADW1112HL, 30 pcs.
Ambient temperature : 28°C
Contact load : 5V DC, 10mA

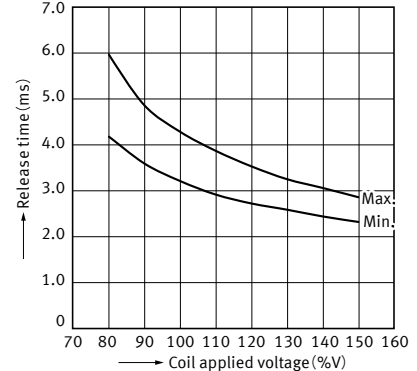

Power relays (Over 2 A) DW RELAYS

5-3. Set time (Inrush type)

Tested sample : ADW1212HL, 30 pcs.
Ambient temperature : 28°C
Contact load : 5V DC, 10mA

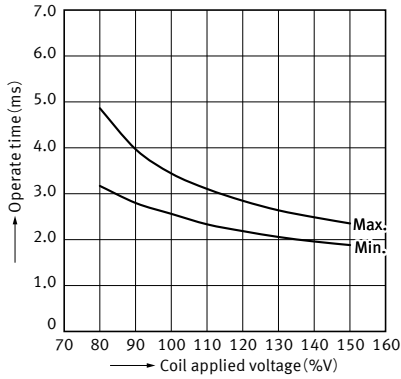

5-4. Reset time (Inrush type)

Tested sample : ADW1212HL, 30 pcs.
Ambient temperature : 28°C
Contact load : 5V DC, 10mA

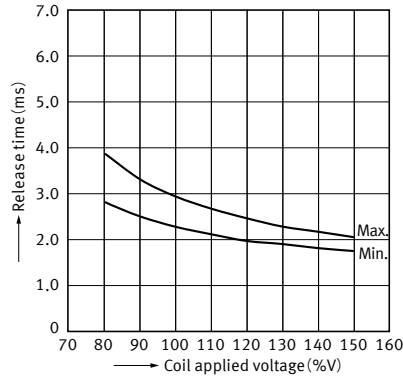

DIMENSIONS

CAD The CAD data of the products with a "CAD" mark can be downloaded from our Website.

Unit: mm

Standard type and Inrush type

CAD

External dimensions

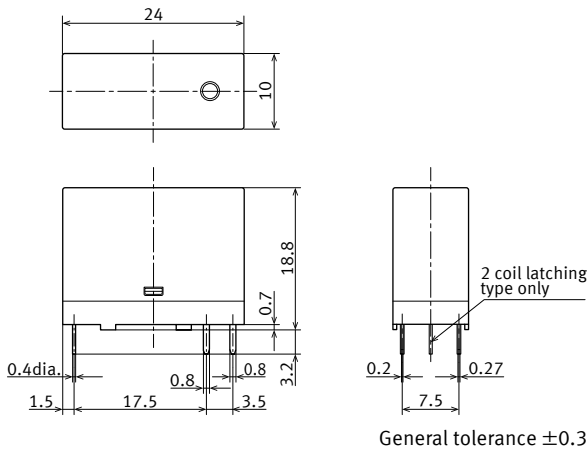

Recommended PC board pattern (BOTTOM VIEW)

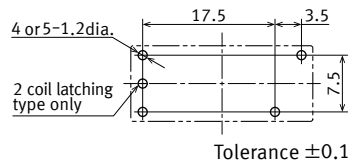

Schematic (BOTTOM VIEW)

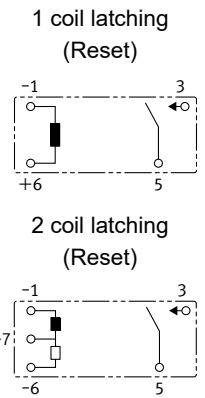

General tolerance ± 0.3

Inrush type (low profile)

CAD

External dimensions

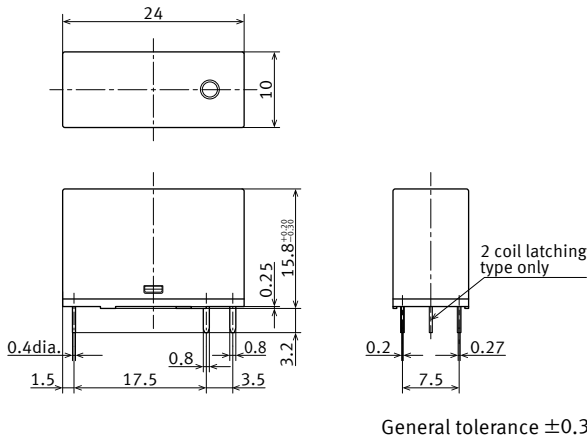

Recommended PC board pattern (BOTTOM VIEW)

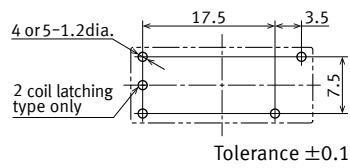

Schematic (BOTTOM VIEW)

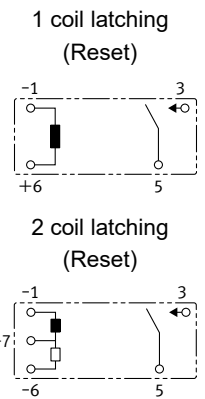

General tolerance ± 0.3

Power relays (Over 2 A) DW RELAYS

SAFETY STANDARDS

Each standard may be updated at any time, so please check our Website for the latest information.

■ UL/C-UL (Approved)

Standard type (ADW****)

File No.	Contact rating	Operations	Ambient temperature
E43149	8 A 250 V AC Resistive	50 x 10 ³	85°C
	5 A 30 V DC Resistive	50 x 10 ³	85°C

Inrush type (ADW****H*)

File No.	Contact rating	Operations	Ambient temperature
E43149	16 A 277 V AC Resistive	50 x 10 ³	60°C
	16 A 277 V AC Resistive	20 x 10 ³	85°C
	8 A 250 V AC Resistive	50 x 10 ³	85°C
	5 A 347 V AC Resistive (UL only)	50 x 10 ³	85°C
	5 A 30 V DC Resistive	50 x 10 ³	85°C
	1,200 W 277 V AC Standard ballast	6 x 10 ³	50°C
	1,200 W 240 V AC Tungsten	6 x 10 ³	50°C
	600 W 120 V AC Tungsten	25 x 10 ³	50°C

Compliant with Electronic ballast

File No.	Contact rating	Operations	Ambient temperature
E43149	5A 277V AC Electronic ballast (UL only)	6 x 10 ³	40°C

Note) Please contact our sales representative for 5 A 277 V AC (Inrush current 320A) compliant with Electronic ballast.

Inrush type (20A)

File No.	Contact rating	Operations	Ambient temperature
E43149	20A 250V AC Resistive	6 x 10 ³	85°C

Note) Please contact our sales representative for Inrush type (20A).

■ CSA (Approved)

CSA standard certified by C-UL

■ VDE (Approved)

Standard type (ADW****)

File No.	Contact rating	Operations	Ambient temperature
40032254	8 A 250 V AC (cosφ=1.0)	50 x 10 ³	85°C
	5 A 30 V DC (0 ms)	50 x 10 ³	85°C

Inrush type (ADW****H*)

File No.	Contact rating	Operations	Ambient temperature
40032254	16 A 277 V AC (cosφ=1.0)	50 x 10 ³	70°C
	16 A 277 V AC (cosφ=1.0)	20 x 10 ³	85°C
	8 A 250 V AC (cosφ=1.0)	50 x 10 ³	85°C
	5 A 30 V DC (0 ms)	50 x 10 ³	85°C

■ TV rating

Inrush type (ADW****H*)

File No.	Rating
UL/C-UL: E43149	TV-8 (240 V AC)

■ CQC (Approved)

Standard type (ADW****)

File No.	Contact rating
CQC16002150890	8 A 250 V AC

Inrush type (ADW****H*)

File No.	Contact rating
CQC16002150890	16 A 250 V AC

INSULATION CHARACTERISTICS (IEC61810-1)

Item	Characteristics
Clearance/Creepage distance (IEC61810-1)	Min. 5.5 mm/5.5 mm
Category of protection (IEC61810-1)	RT II
Tracking resistance (IEC60112)	PTI 175 (IEC60335-1 compliant: PTI 325)
Insulation material group	III a
Over voltage category	III
Rated voltage	250 V
Pollution degree	2
Type of insulation (Between contact and coil)	Reinforced insulation
Type of insulation (Between open contacts)	Micro disconnection

Note: EN/IEC VDE Certified

GUIDELINES FOR USAGE

■ For cautions for use, please read “GUIDELINES FOR RELAY USAGE”.
https://industrial.panasonic.com/ac/e/control/relay/cautions_use/index.jsp

■ Cautions for usage of DW relays

● Set and reset pulse time

Regarding the set and reset pulse time of the latching type, for the purpose of reliable operation under ambient temperature fluctuations and different operating conditions, we recommend setting the coil applied set and reset pulse time to 30 ms or more at the rated coil voltage.

● Solder and cleaning conditions

<Reflow solder mounting conditions>

- IRS heat conditions (recommended conditions; number of reflows: 1 time, measurement location: surface of PC board where relay is installed)

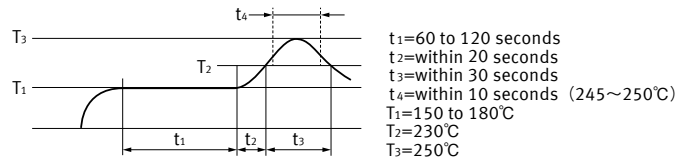

• Mounting cautions

Cautions to observe when mounting temperature increases in the relay are greatly dependent on the way different parts are located a PC board and the heating method of the reflow device. Therefore, please conduct testing on the actual device beforehand after making sure the parts soldered on the relay terminals and the top of the relay case are within the temperature conditions given above.

GUIDELINES FOR POWER, HIGH-CAPACITY DC CUT OFF AND SAFETY RELAYS USAGE

■ For cautions for use, please read “GUIDELINES FOR RELAY USAGE”.
https://industrial.panasonic.com/ac/e/control/relay/cautions_use/index.jsp

Precautions for Coil Input

■ Long term current carrying

A circuit that will be carrying a current continuously for long periods without relay switching operation. (circuits for emergency lamps, alarm devices and error inspection that, for example, revert only during malfunction and output warnings with form B contacts)
Continuous, long-term current to the coil will facilitate deterioration of coil insulation and characteristics due to heating of the coil itself. For circuits such as these, please use a magnetic-hold type latching relay. If you need to use a single stable relay, use a sealed type relay that is not easily affected by ambient conditions and make a failsafe circuit design that considers the possibility of contact failure or disconnection.

■ DC Coil operating power

Steady state DC current should be applied to the coil. The wave form should be rectangular. If it includes ripple, the ripple factor should be less than 5%.

However, please check with the actual circuit since the electrical characteristics may vary. The rated coil voltage should be applied to the coil and the set/reset pulse time of latching type relay differs for each relays, please refer to the relay's individual specifications.

■ Coil connection

When connecting coils of polarized relays, please check coil polarity (+,-) at the internal connection diagram (Schematic). If any wrong connection is made, it may cause unexpected malfunction, like abnormal heat, fire and so on, and circuit do not work. Avoid impressing voltages to the set coil and reset coil at the same time.

Ambient Environment

■ Usage, Transport, and Storage Conditions

During usage, storage, or transportation, avoid locations subjected to direct sunlight and maintain normal temperature, humidity and pressure conditions.

● Temperature/Humidity/Pressure

When transporting or storing relays while they are tube packaged, there are cases the temperature may differ from the allowable range. In this case be sure to check the individual specifications. Also allowable humidity level is influenced by temperature, please check charts shown below and use relays within mentioned conditions. (Allowable temperature values differ for each relays, please refer to the relay's individual specifications.)

1) Temperature:

The tolerance temperature range differs for each relays, please refer to the relay's individual specifications

2) Humidity: 5 to 85 % RH

3) Pressure: 86 to 106 kPa

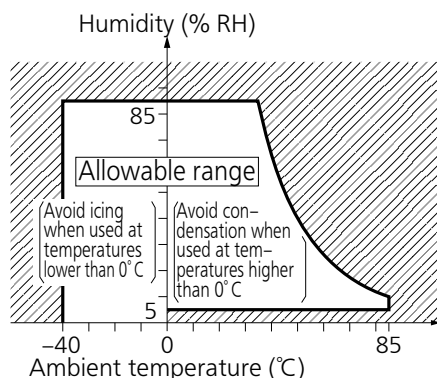

■ Maximum allowable voltage and temperature rise

Proper usage requires that the rated coil voltage be impressed on the coil. Note, however, that if a voltage greater than or equal to the maximum continuous voltage is impressed on the coil, the coil may burn or its layers short due to the temperature rise. Furthermore, do not exceed the usable ambient temperature range listed in the catalog.

■ Operate voltage change due to coil temperature rise

In DC relays, after continuous passage of current in the coil, if the current is turned OFF, then immediately turned ON again, due to the temperature rise in the coil, the operate voltage will become somewhat higher. Also, it will be the same as using it in a higher temperature atmosphere. The resistance/temperature relationship for copper wire is about 0.4% for 1°C, and with this ratio the coil resistance increases. That is, in order to operate of the relay, it is necessary that the voltage be higher than the operate voltage and the operate voltage rises in accordance with the increase in the resistance value. However, for some polarized relays, this rate of change is considerably smaller.

● Dew condensation

Condensation occurs when the ambient temperature drops suddenly from a high temperature and humidity, or the relay is suddenly transferred from a low ambient temperature to a high temperature and humidity. Condensation causes the failures like insulation deterioration, wire disconnection and rust etc. Panasonic Corporation does not guarantee the failures caused by condensation.

The heat conduction by the equipment may accelerate the cooling of device itself, and the condensation may occur.

Please conduct product evaluations in the worst condition of the actual usage. (Special attention should be paid when high temperature heating parts are close to the device. Also please consider the condensation may occur inside of the device.)

● Icing

Condensation or other moisture may freeze on relays when the temperature become lower than 0°C. This icing causes the sticking of movable portion, the operation delay and the contact conduction failure etc. Panasonic Corporation does not guarantee the failures caused by the icing.

The heat conduction by the equipment may accelerate the cooling of relay itself and the icing may occur. Please conduct product evaluations in the worst condition of the actual usage.

● Low temperature and low humidity

The plastic becomes brittle if the switch is exposed to a low temperature, low humidity environment for long periods of time.

● High temperature and high humidity

Storage for extended periods of time (including transportation periods) at high temperature or high humidity levels or in atmospheres with organic gases or sulfide gases may cause a sulfide film or oxide film to form on the surfaces of the contacts and/or it may interfere with the functions. Check out the atmosphere in which the units are to be stored and transported.

● Package

In terms of the packing format used, make every effort to keep the effects of moisture, organic gases and sulfide gases to the absolute minimum.

● Silicon

When a source of silicone substances (silicone rubber, silicone oil, silicone coating materials and silicone filling materials etc.) is used around the relay, the silicone gas (low molecular siloxane etc.) may be produced.

This silicone gas may penetrate into the inside of the relay. When the relay is kept and used in this condition, silicone compound may adhere to the relay contacts which may cause the contact failure.

Do not use any sources of silicone gas around the relay (Including plastic seal types).

● NOx Generation

When relay is used in an atmosphere high in humidity to switch a load which easily produces an arc, the NOx created by the arc and the water absorbed from outside the relay combine to produce nitric acid.

This corrodes the internal metal parts and adversely affects operation.

Avoid use at an ambient humidity of 85%RH or higher (at 20°C). If use at high humidity is unavoidable, please contact our sales representative.

Others

■ Cleaning

• Although the environmentally sealed type relay (plastic sealed type, etc.) can be cleaned, avoid immersing the relay into cold liquid (such as cleaning solvent) immediately after soldering. Doing so may deteriorate the sealing performance.

• Cleaning with the boiling method is recommended(The temperature of cleaning liquid should be 40°C or lower).

Avoid ultrasonic cleaning on relays. Use of ultrasonic cleaning may cause breaks in the coil or slight sticking of the contacts due to ultrasonic energy.

Please refer to **"the latest product specifications"** when designing your product.

•Requests to customers:

<https://industrial.panasonic.com/ac/e/salespolicies/>

Panasonic
INDUSTRY

Panasonic Industry Co., Ltd.

Electromechanical Control Business Division
■1006, Oaza Kadoma, Kadoma-shi, Osaka 571-8506, Japan
industrial.panasonic.com/ac/e/