

# ANT-LTE-WS-SMA

## Data Sheet



### Product Description

The Linx LTE Blade Dipole Antenna is an affordable and compact antenna with high peak gain.

It is well suited for LTE customers looking for a modern upgrade to the previous generations' clunky blade antennas or are moving away from 3G only bands. The antenna blade itself is only 11.5cm long and 2cm across.

No tuning or ground plane are required. The LTE Blade Dipole Antenna greatly reduces the risk of implementation, making it a true plug and go solution.

It covers the LTE, LTE-M (CAT-M1) & NB-IoT bands while still performing well in the sub 1 GHz bands. The antenna is well suited for use with both plastic and metal enclosures, and its affordable price point, small-size and modern design offers customers a low-profile option for a more aesthetically pleasing product.



### Features

- Covers all common 4G/3G/2G and LTE bands
- Tilt / Swivel Joint for optimum positioning
- Thoroughly tested and validated

### Ordering Information

ANT-LTE-WS-SMA

### Electrical Specifications

Electrical Specifications				
Parameter	LTE/ GSM850/ GSM900	DCS/ PCS/ UMTS1	LTE 2300	LTE 2600
Recommended Frequency Range	698 – 960	1710 – 2170	2300 – 2400	2500 – 2700
VSWR (typical at center)	<2.0:1	<2.0:1	<2.0:1	<2.5:1
Peak Gain (max in the band)	4.09dBi	5.86dBi	3.13dBi	4.06dBi
Average Gain (typical)	-1.78dBi	-0.45dBi	-1.39dBi	-1.27dBi
Efficiency (typical)	65%	70%	70%	70%
Polarization	Linear			
Radiation	Omni-Directional			
Max Power	5W			
Wavelength	1/2-wave			
Impedance	50-ohms			
Connection	SMA Plug (Male)			
Weight	1.4g (0.05oz.)			
Operating Temperature Range	-20°C to +65°C			

Measurements taken attached to a straight cable with no ground plane.

## Dimensions

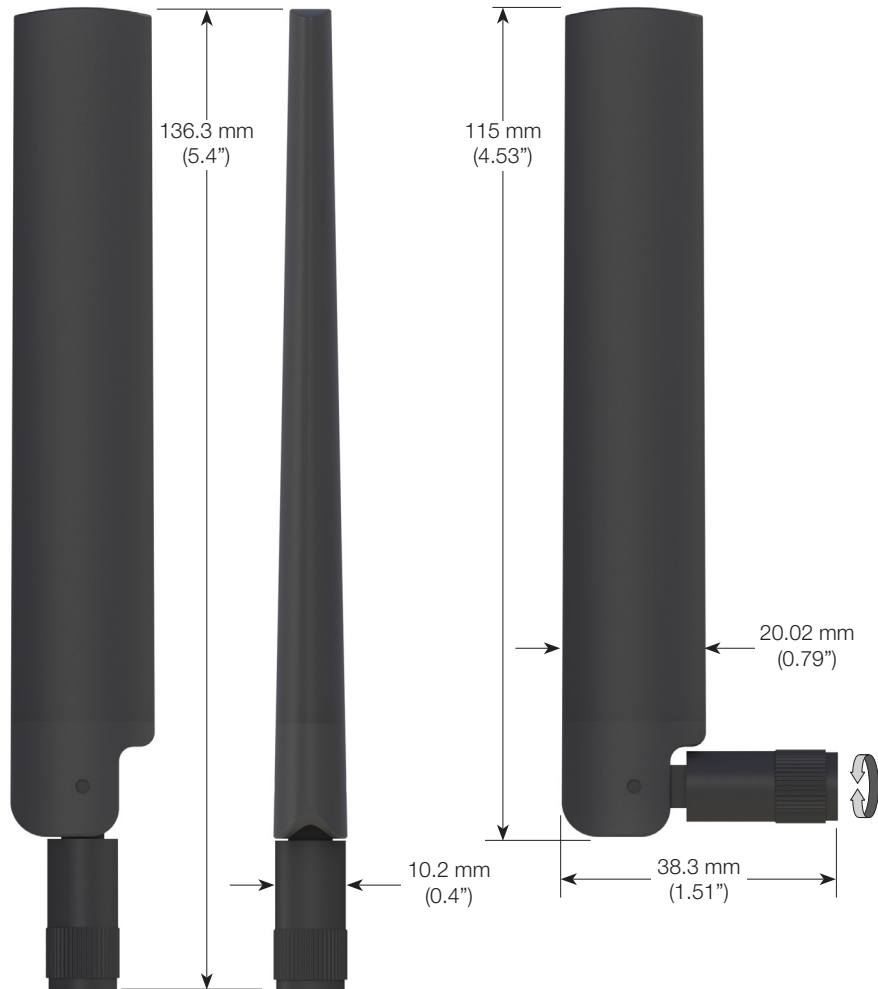

## Dipole antennas, ground planes and additional orientations

Due to the superior design nature of a dipole antenna, an external ground plane is not required for the antenna to radiate properly since dipole antennas already have the ground plane built in, and most external antennas are commonly mounted to enclosures, conductive or non-conductive. Linx knows how our antennas are most frequently used in customers' designs so we test our antennas in several different configurations, such as straight, without ground (free space), straight, center of a ground and edge of a ground bent at 90°.

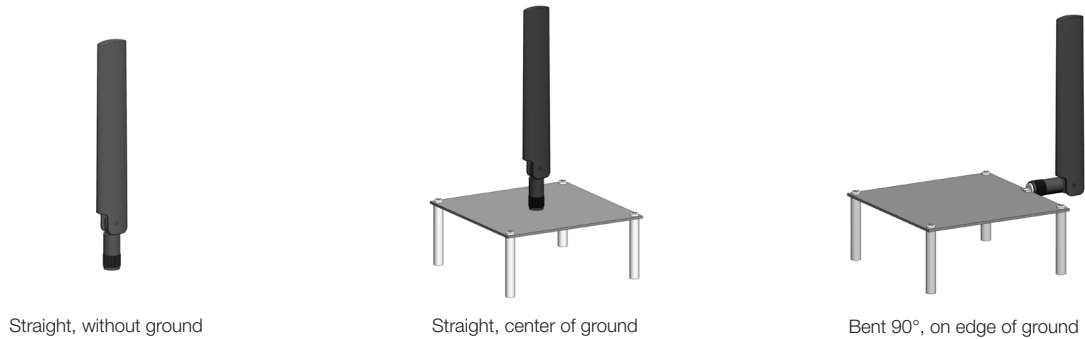

Linx tested the WS dipole antenna in 3 different, common orientations, both in free space and on a ground plane to ensure excellent radiation behavior and minimize the risk to the customer when implementing a new design, regardless of complexity.

Additionally, there are many other configurations with which our WS antenna will have similar performance to the *Straight, center of ground*, and *Bent 90°, on edge of ground*, with minimal difference, as shown below in fig. 1 and fig. 2.

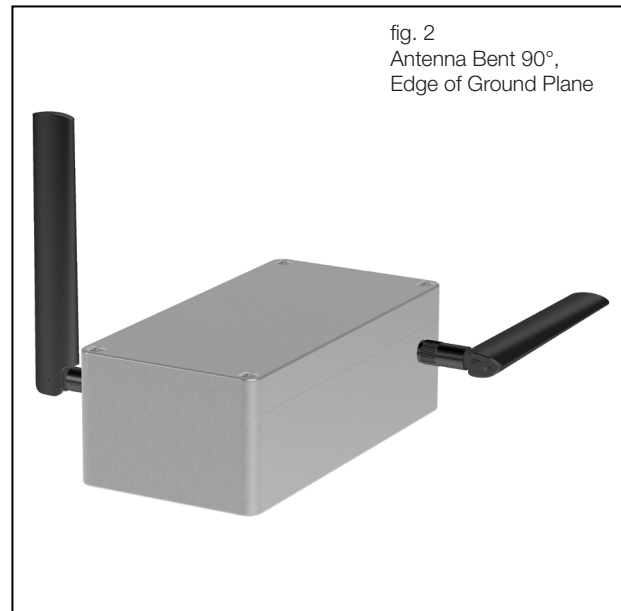
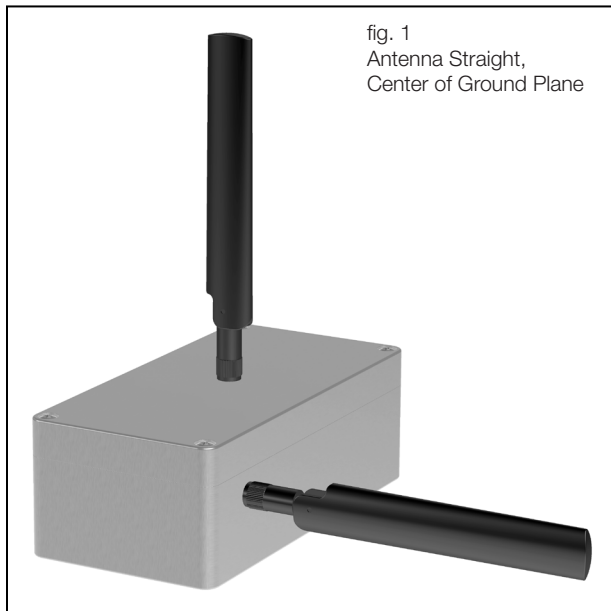

## Antenna straight on nonconductive surface/ Free space



### VSWR

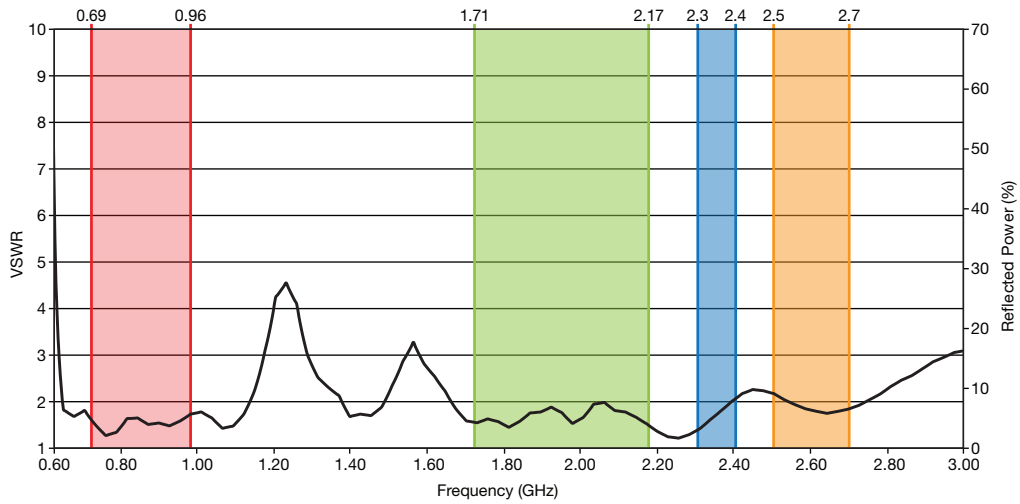

### Return Loss

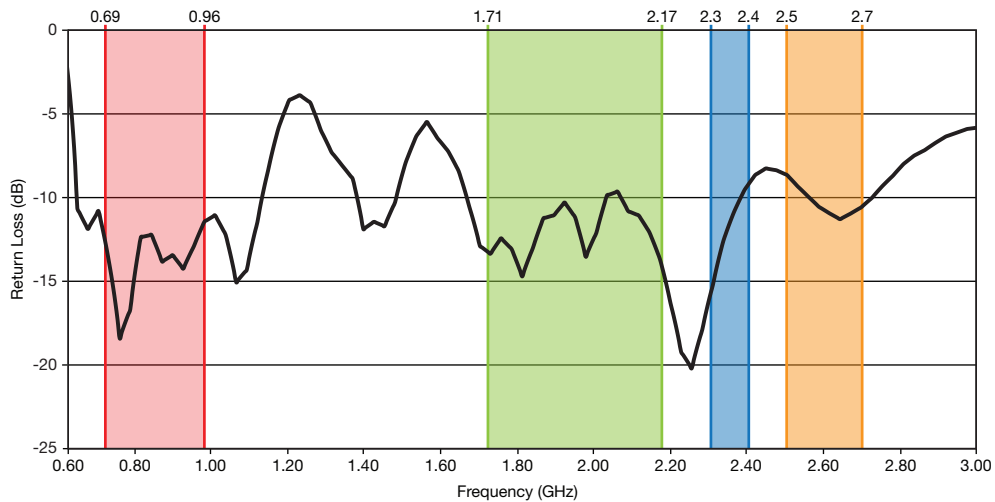

## Peak Gain

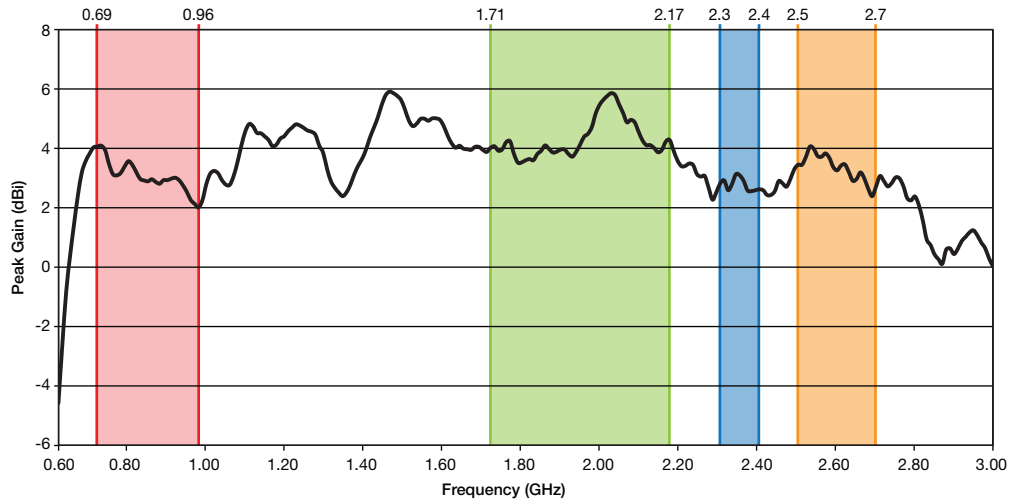

## Average Gain

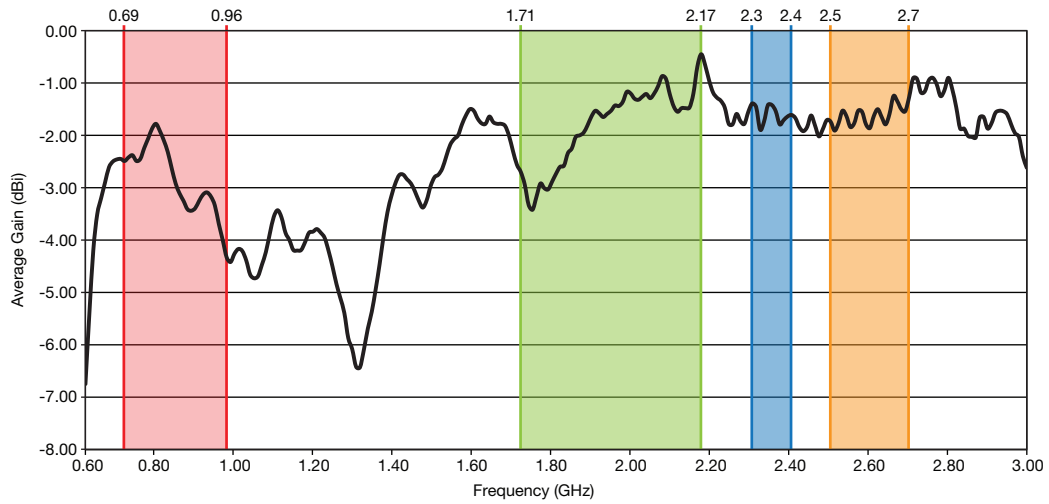

## Radiation Efficiency

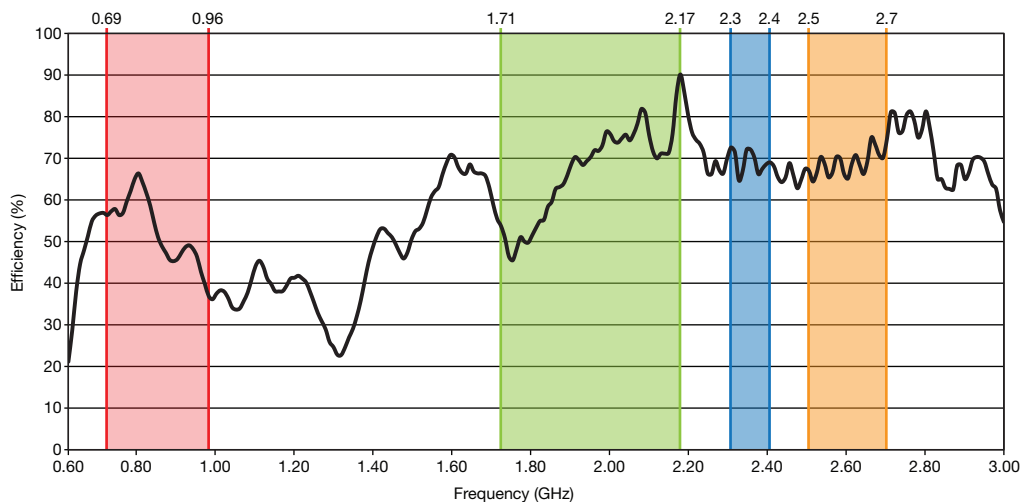

## Gain Plots - Antenna straight on nonconductive surface/ Free space

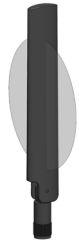

XZ-Plane Gain

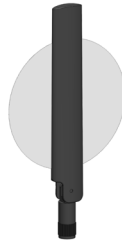

YZ-Plane Gain

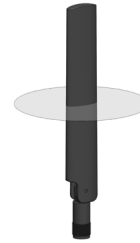

XY-Plane Gain

### 700 - 960MHz

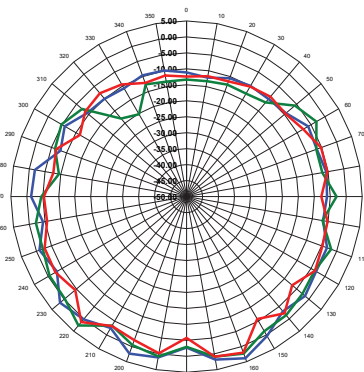

XZ-Plane Gain

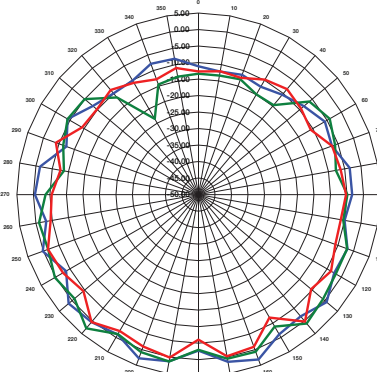

YZ-Plane Gain

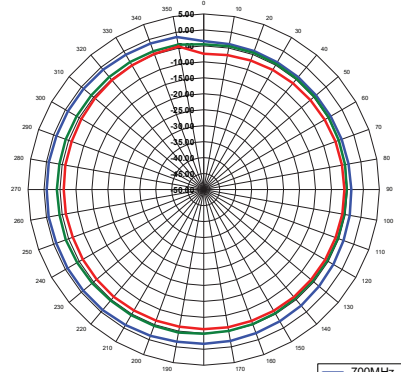

XY-Plane Gain



### 1710 - 2170MHz

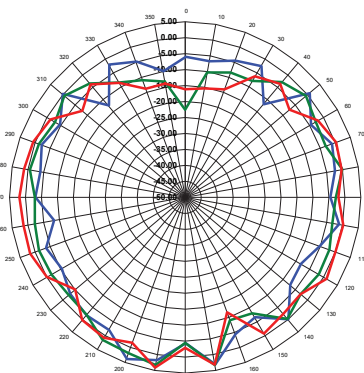

XZ-Plane Gain

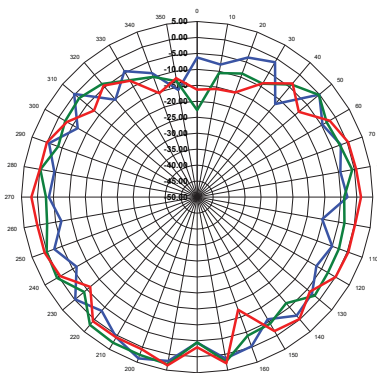

YZ-Plane Gain

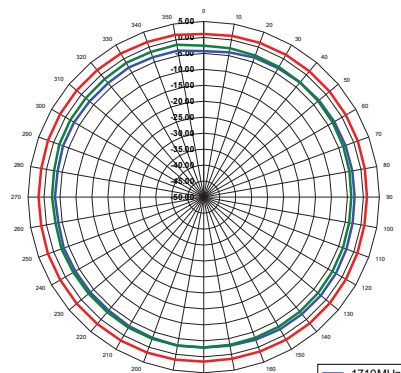

XY-Plane Gain



## Gain Plots - Antenna straight on nonconductive surface/ Free space

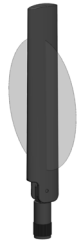

XZ-Plane Gain

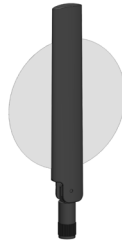

YZ-Plane Gain

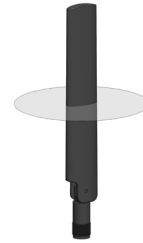

XY-Plane Gain

### 2300 - 2400MHz

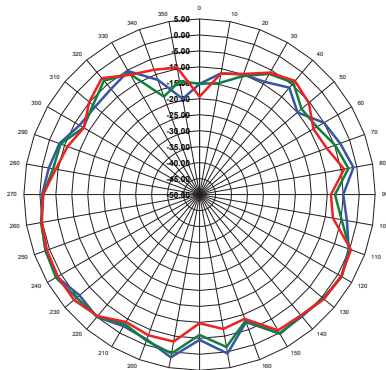

XZ-Plane Gain

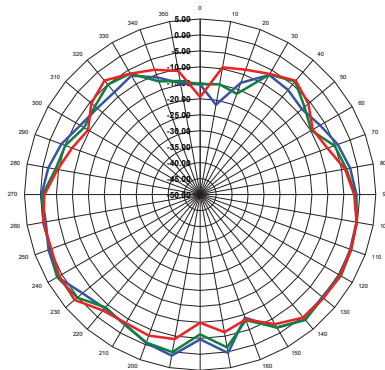

YZ-Plane Gain

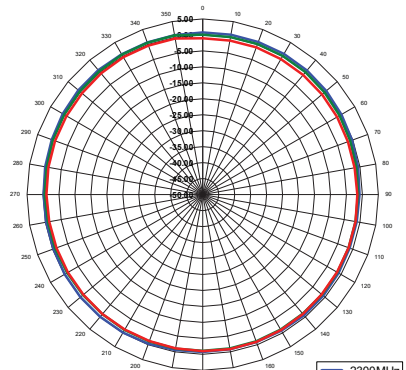

XY-Plane Gain



### 2500 - 2700MHz

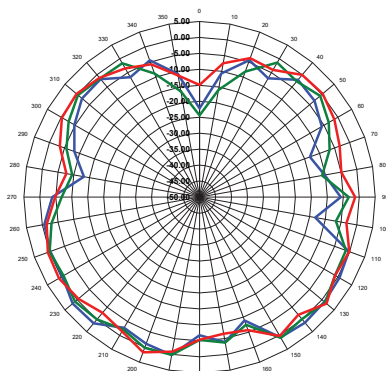

XZ-Plane Gain

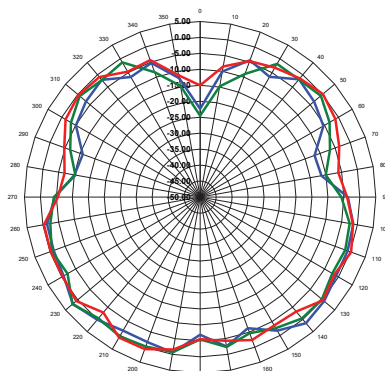

YZ-Plane Gain

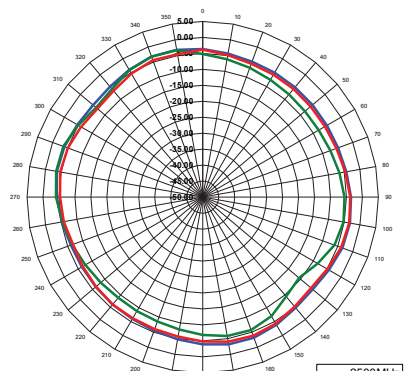

XY-Plane Gain



## Center of the Ground Plane, Straight

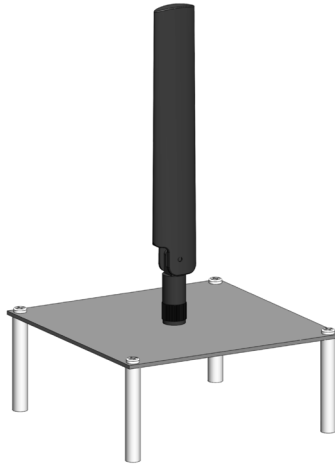

### VSWR

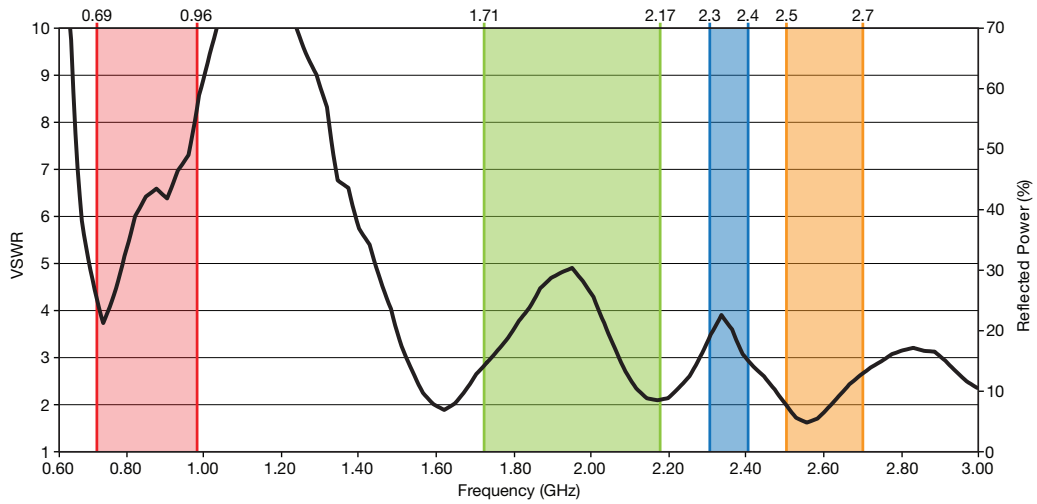

### Return Loss

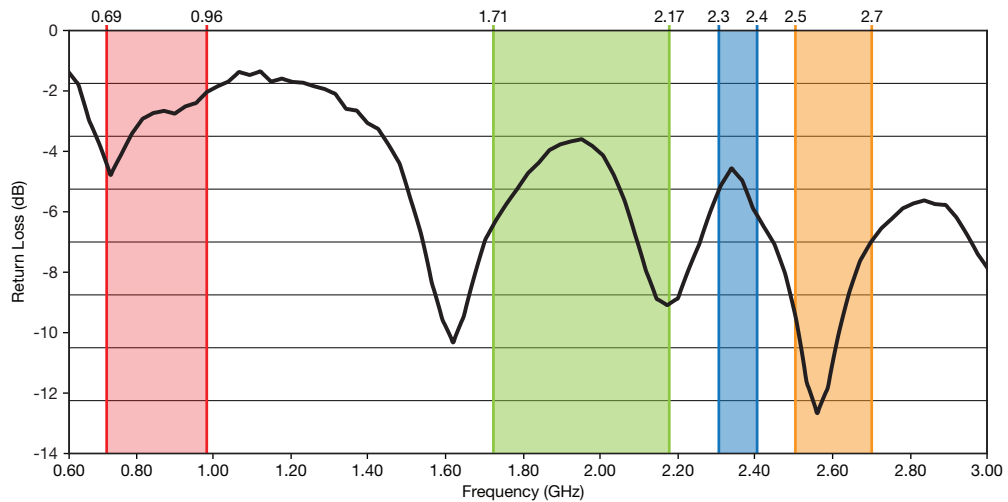



### Peak Gain

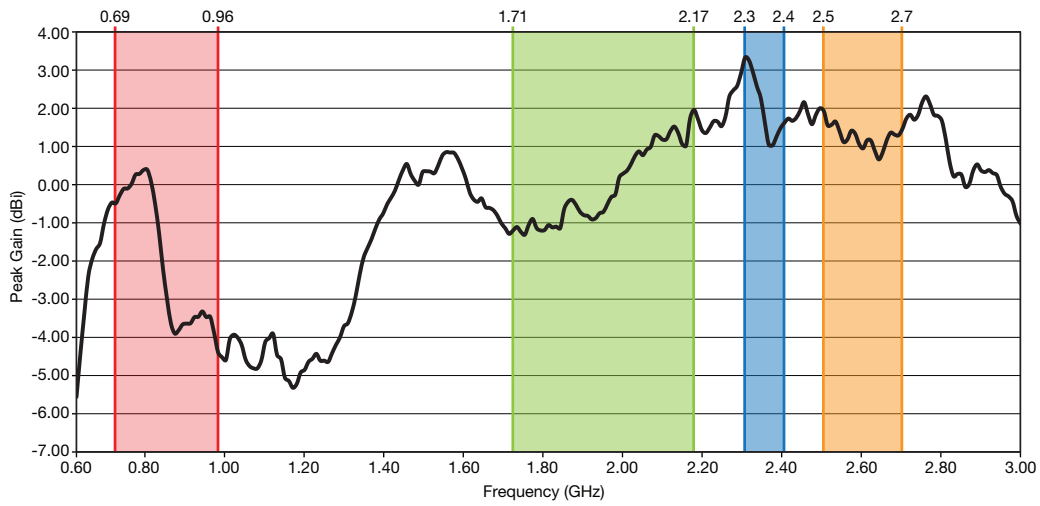

### Average Gain

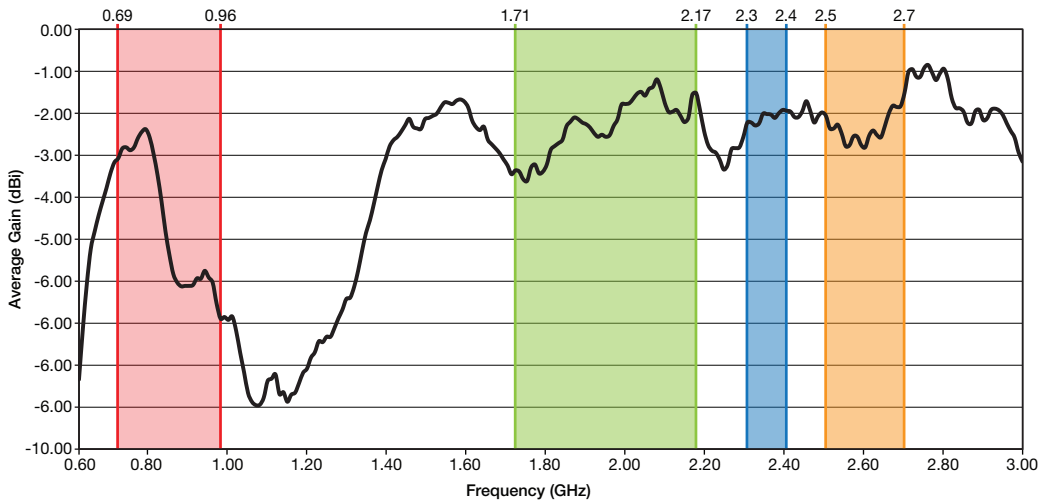

### Radiation Efficiency

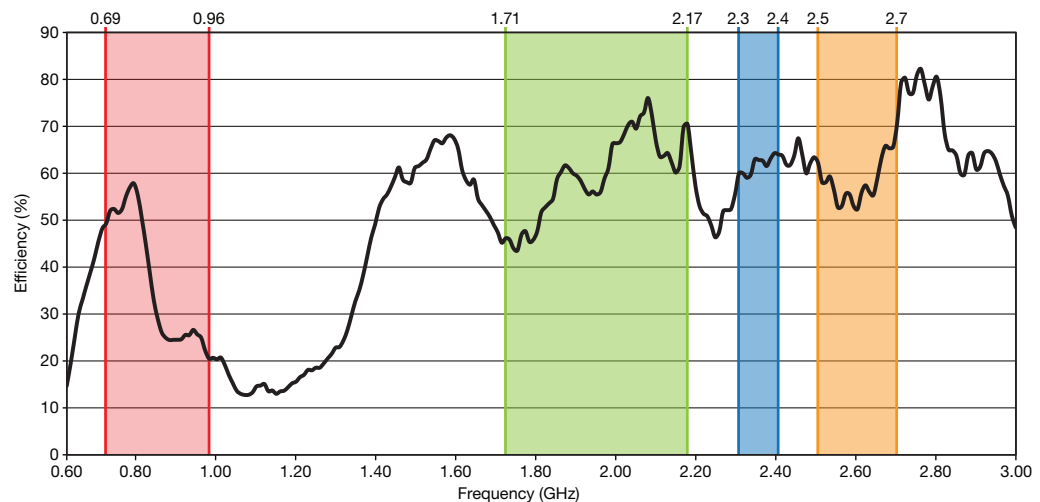

## Gain Plots - Center of Plane, Straight

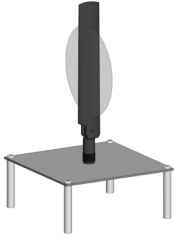

XZ-Plane Gain

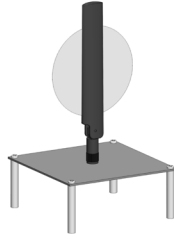

YZ-Plane Gain

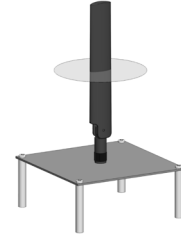

XY-Plane Gain

### 700 - 960MHz

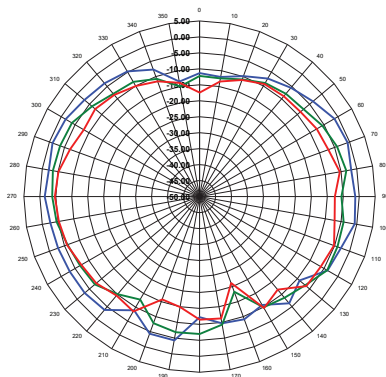

XZ-Plane Gain

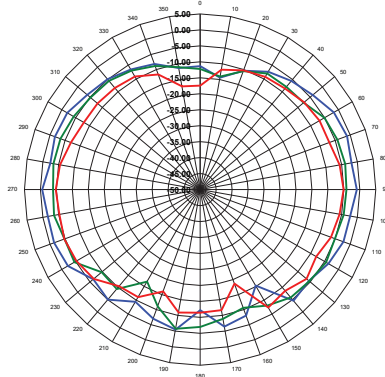

YZ-Plane Gain

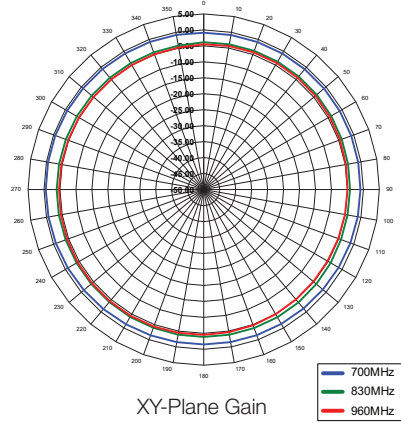

XY-Plane Gain



### 1710 - 2170MHz

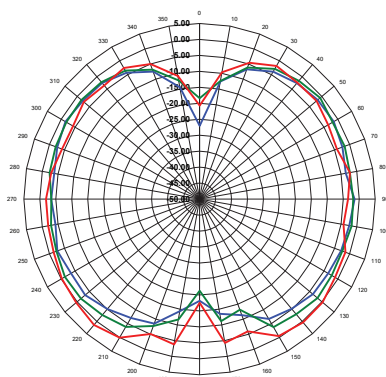

XZ-Plane Gain

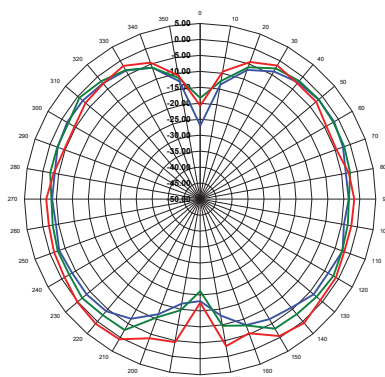

YZ-Plane Gain

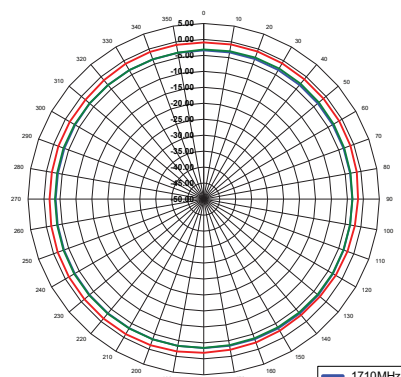

XY-Plane Gain



## Gain Plots - Center of Plane, Straight

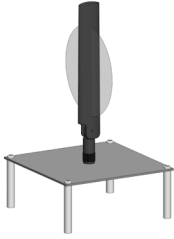

XZ-Plane Gain

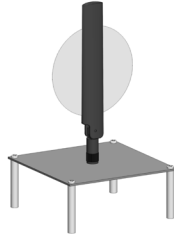

YZ-Plane Gain

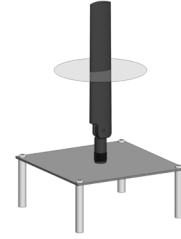

XY-Plane Gain

### 2300 - 2400MHz

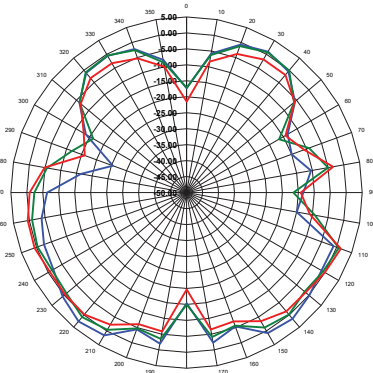

XZ-Plane Gain

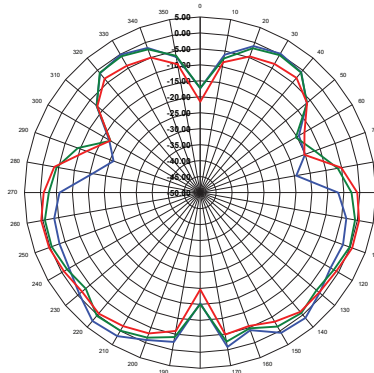

YZ-Plane Gain

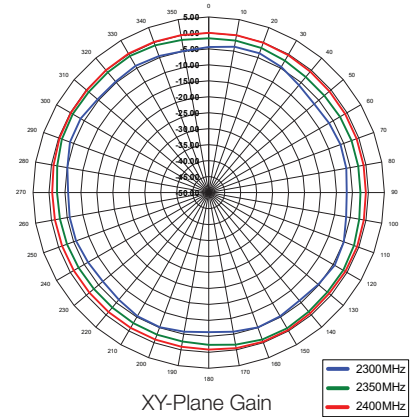

XY-Plane Gain



### 2500 - 2700MHz

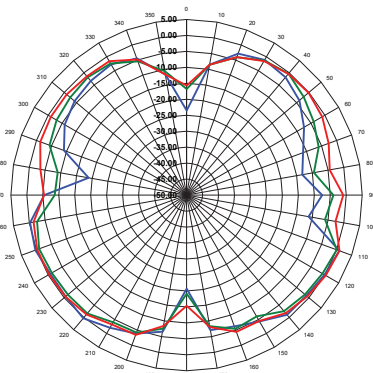

XZ-Plane Gain

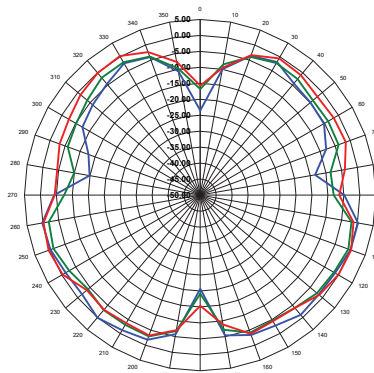

YZ-Plane Gain

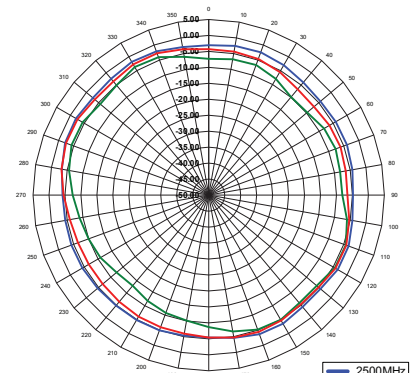

XY-Plane Gain



## Edge of the Ground Plane, Bent 90°

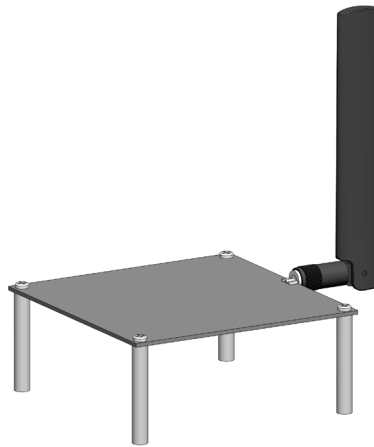

### VSWR

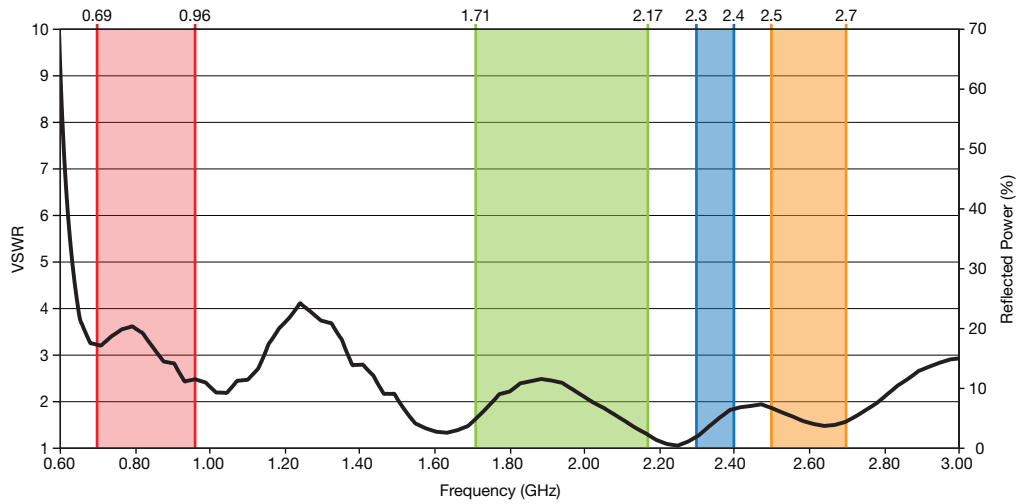

### Return Loss

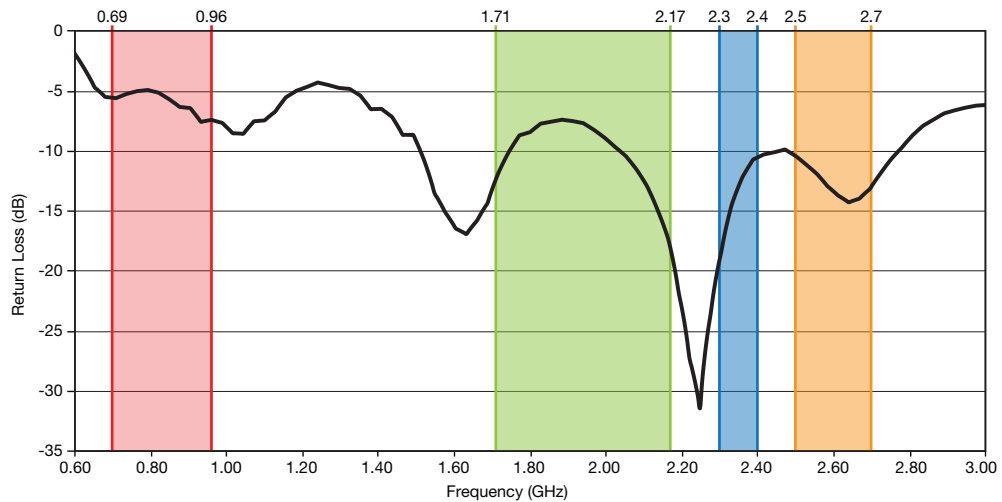

### Peak Gain

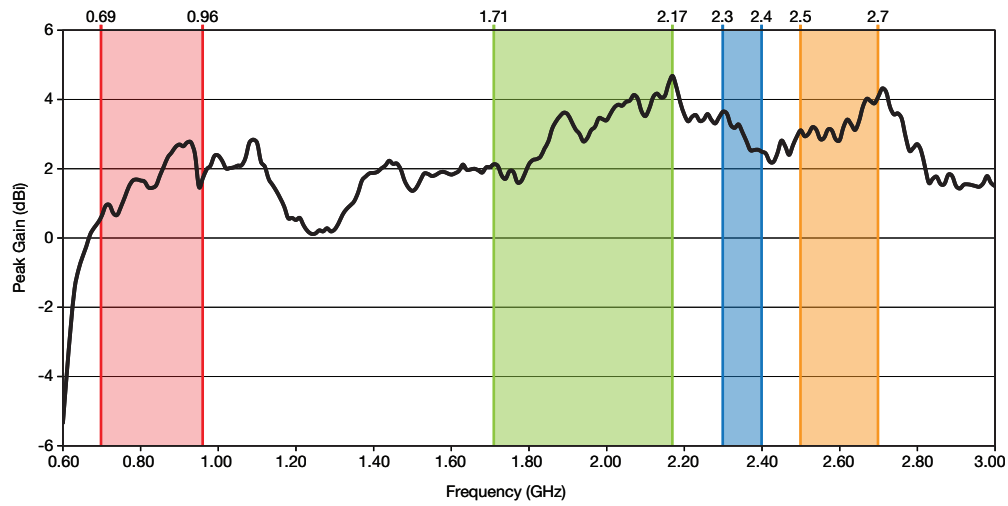

### Average Gain

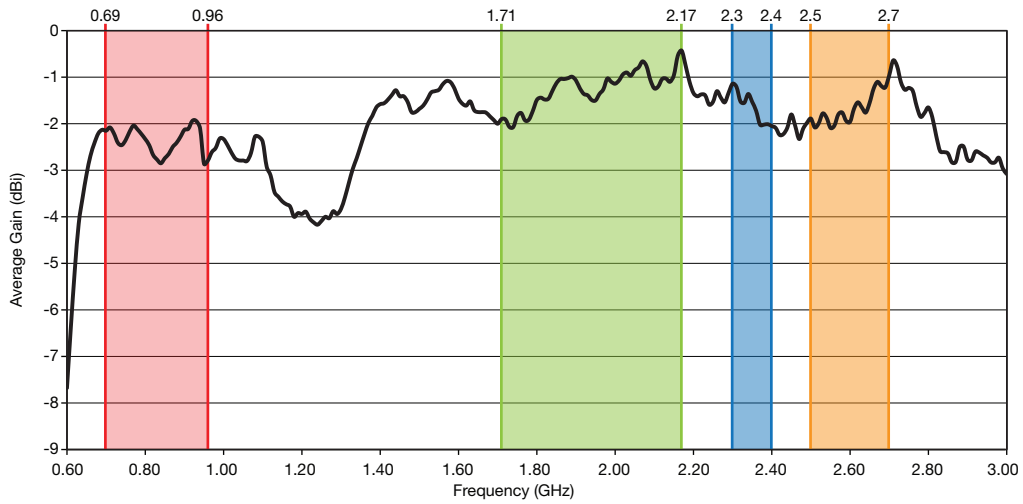

### Radiation Efficiency

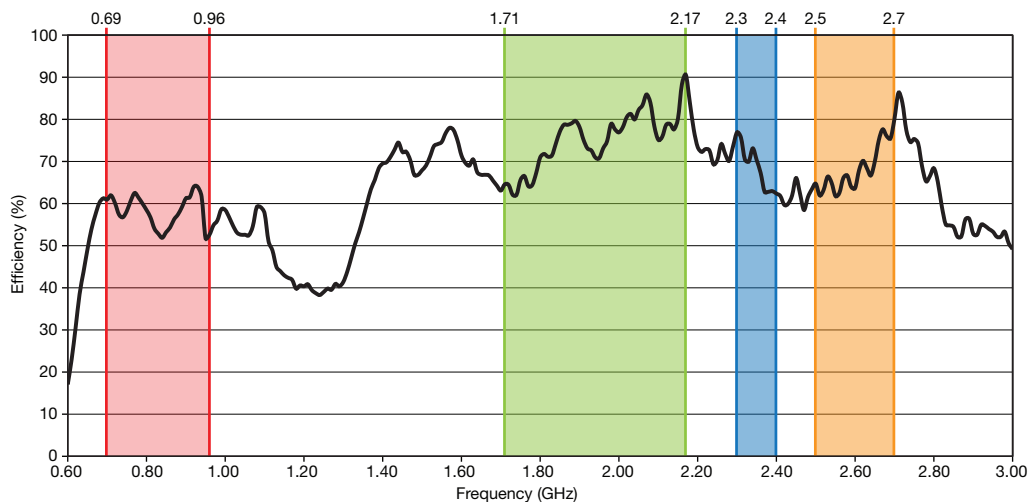

## Gain Plots - Edge of Plane, Bent 90°

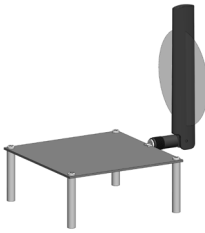

XZ-Plane Gain

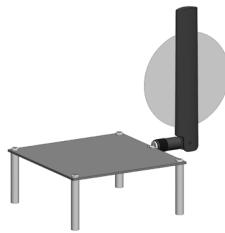

YZ-Plane Gain

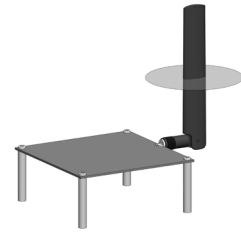

XY-Plane Gain

### 700 - 960MHz

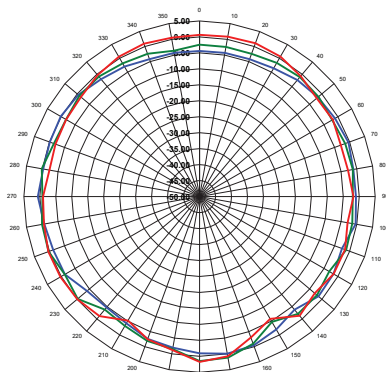

XZ-Plane Gain

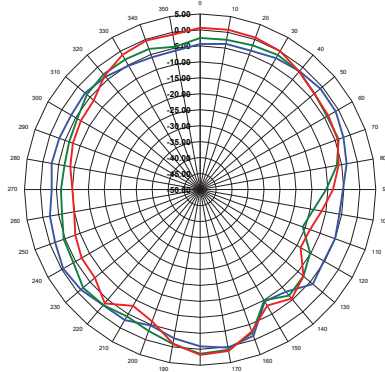

YZ-Plane Gain

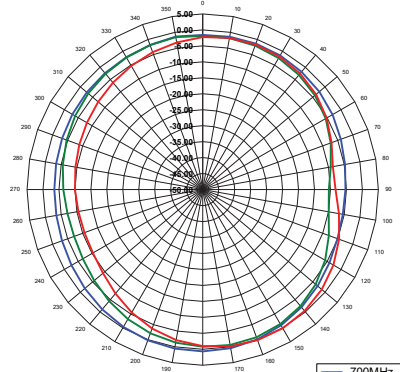

XY-Plane Gain



### 1710 - 2170MHz

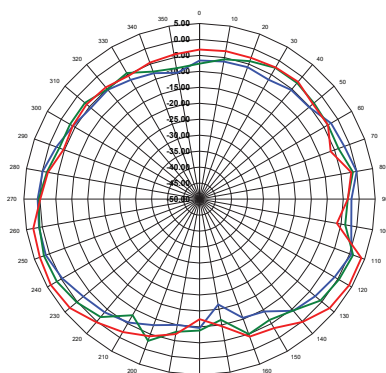

XZ-Plane Gain

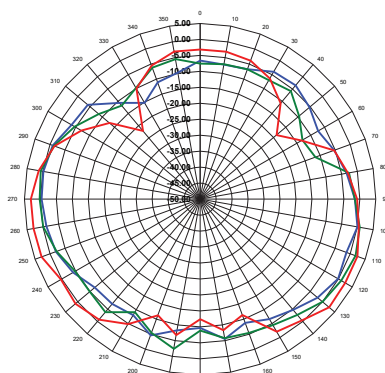

YZ-Plane Gain

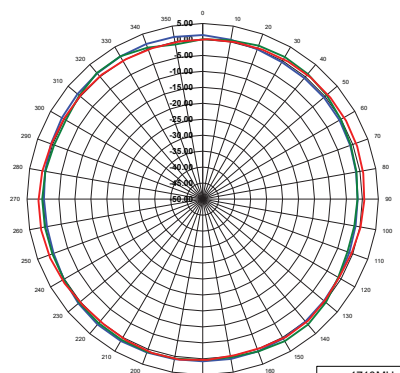

XY-Plane Gain



## Gain Plots - Edge of Plane, Bent 90°

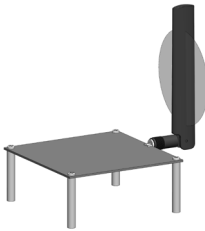

XZ-Plane Gain

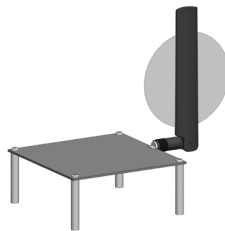

YZ-Plane Gain

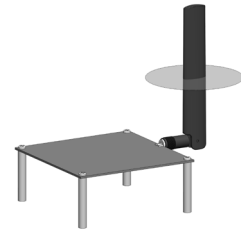

XY-Plane Gain

### 2300 - 2400MHz

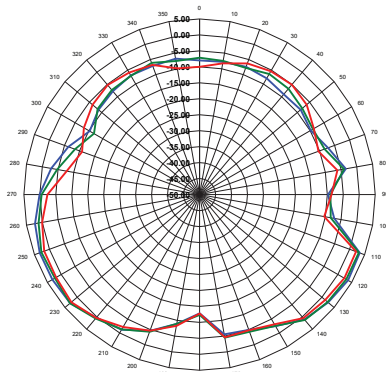

XZ-Plane Gain

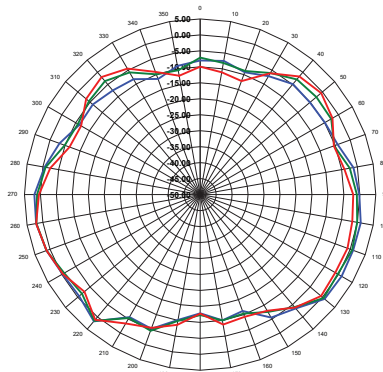

YZ-Plane Gain

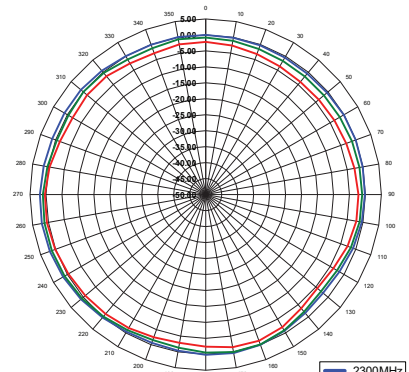

XY-Plane Gain



### 2500 - 2700MHz

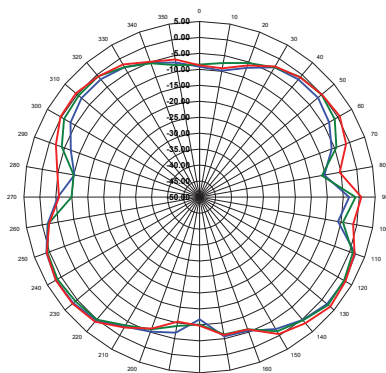

XZ-Plane Gain

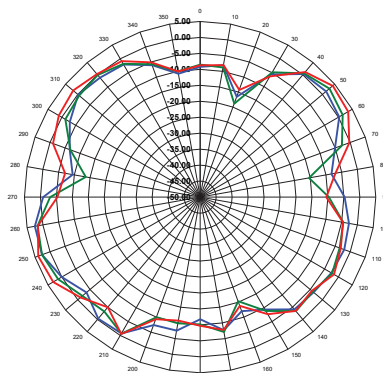

YZ-Plane Gain

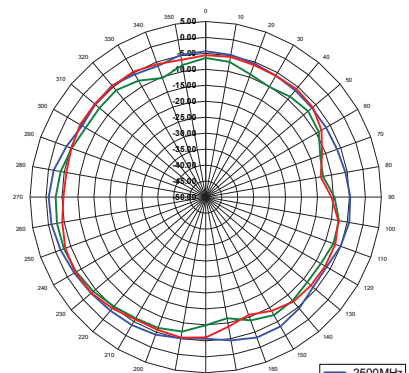

XY-Plane Gain



## Matching Network

Linx tests all our antennas in ideal scenarios where effects from conductive surfaces, non-conductive surfaces or human proximity issues are eliminated. As a designer, you do not have much control over the environment your product will be used in.

Linx has always worked closely with our customers, and we know what the primary concerns and pitfalls are for designers and how to prepare for them. Whether you are designing for a monopole or a dipole antenna, or an external or even an embedded surface mount antenna, the most common question is, “Why isn’t my design working?”, and frequently it turns out the design needed a matching network.

As your product design progresses, the chances for proximity effect increases as other components are added. Some components can act like ground planes, if they have large conductive surface areas, and can cause interference. This interference is called proximity effect, which can cause a downward shift in the center frequency of the circuit, depending on how strong the effects are. Proximity effect is commonly caused by components like pc boards, batteries, motors, sensors, actuators and even non-conductive enclosures like radomes. Interference can also occur from human proximity, like when using a hand-held mobile device.

Although our dipole antennas have been designed to minimize these effects, we strongly recommend the use of a matching network, so you can ensure that you retain optimum signal levels. A matching network is a circuit that balances the impedance and ensures there is minimum reflected energy coming back from the antenna. This enables the integrator to optimize the performance in a specific band or to level performance across all bands. The most common matching network design is called a Pi circuit, placed between the antenna and the radio; it is a simple circuit of two capacitors to ground on either side of a series inductor.

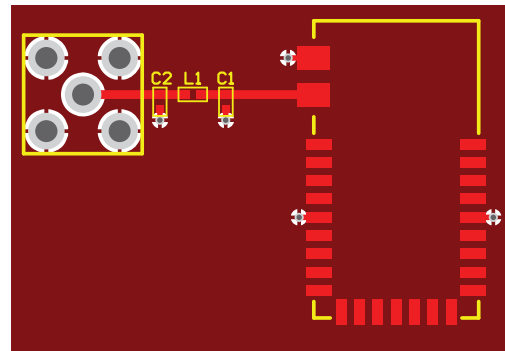
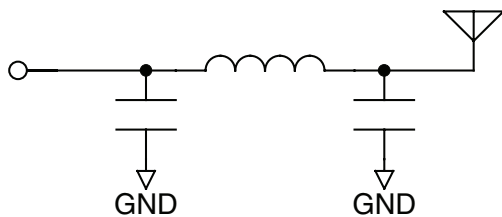

The values can be selected to electrically tune the antenna. It does take test equipment, such as a network analyzer, to get this right though. Often a design ends up having little or no proximity effect, eliminating the need to retune the matching section. In these cases, the matching section can have a zero ohm resistor in place of the Inductor, leaving the other two shunt components un-populated.

The values of the matching components are determined experimentally on the product’s board. Since there are many variables that play into the antenna’s final performance, it is very difficult to predict what it will do on any specific design. It is best to design in the matching network, see what the antenna does on the prototype and then dial the performance in with the network components. Not all of the components may be needed on a particular design, so they do not need to be populated in production; but it is a good idea to have the component pads on the board in case they are needed. The components should be placed close to the antenna connection. The component pads should be placed on the 50-ohm line between the radio and the antenna.

Linx Technologies offers a service to help customers tune our antennas to their circuit boards. Please contact Linx for more details.

Copyright © 2018 Linx Technologies

159 Ort Lane, Merlin, OR 97532  
Phone: +1 541 471 6256  
Fax: +1 541 471 6251  
www.linxtechnologies.com