

**SPECIFICATIONS:**

Voltage Rating: 300V AC/DC  
 Current Rating: 3A AC/DC  
 Withstanding Voltage: 1700V AC/Minute  
 Temperature Range: -25°C~+85°C  
 Insulation Resistance: 1000MΩ Min.  
 Contact Resistance: 20mΩ Max.

**Assembly Layout:**

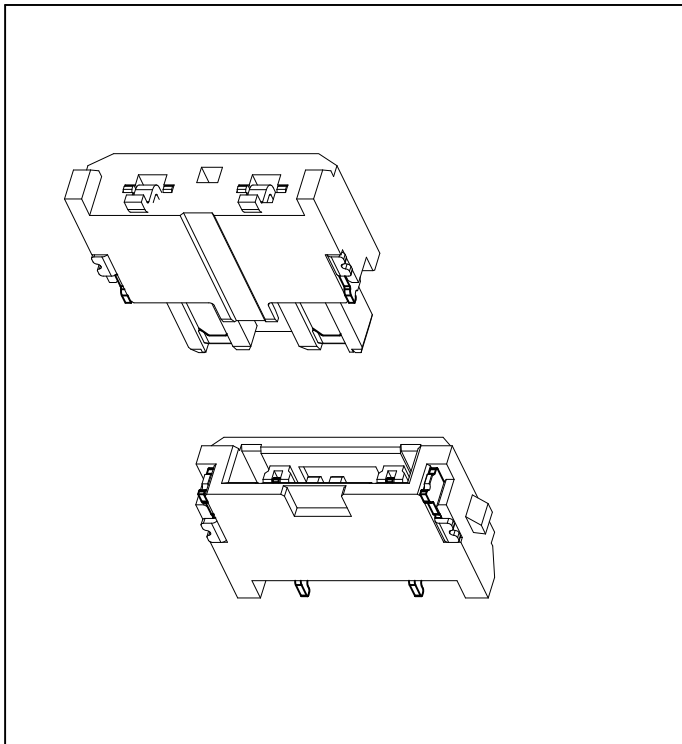
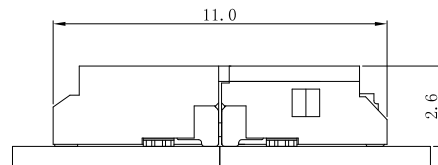

**B4000HF-NP-P0WH**

4.00mm Pitch Single Row Housing

Reference Informations:

\*Material:

Housing: PBT UL94V-0/Natural

\*Suitable LDZY B4000 series Terminal

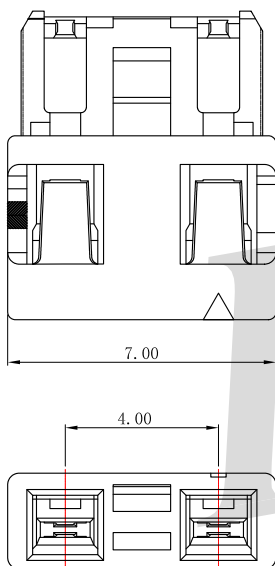

B4000HF-02-P0WH

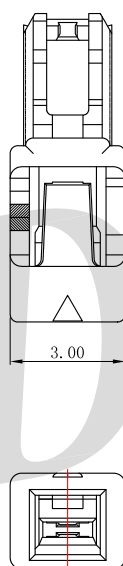

B4000HF-01-P0WH

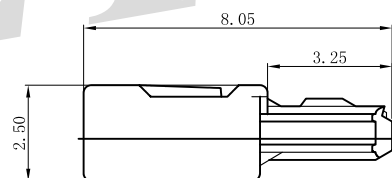

**B4000TF-PT1**

4.00mm Pitch Terminal

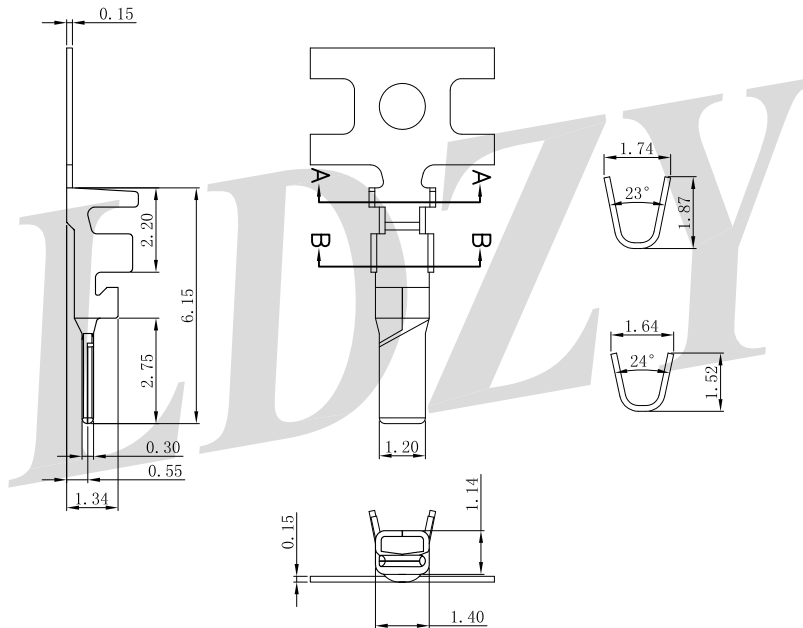

**B4000WRMS-02-L0NAT**

4.00mm Pitch 90° SMT Single Row Wafer

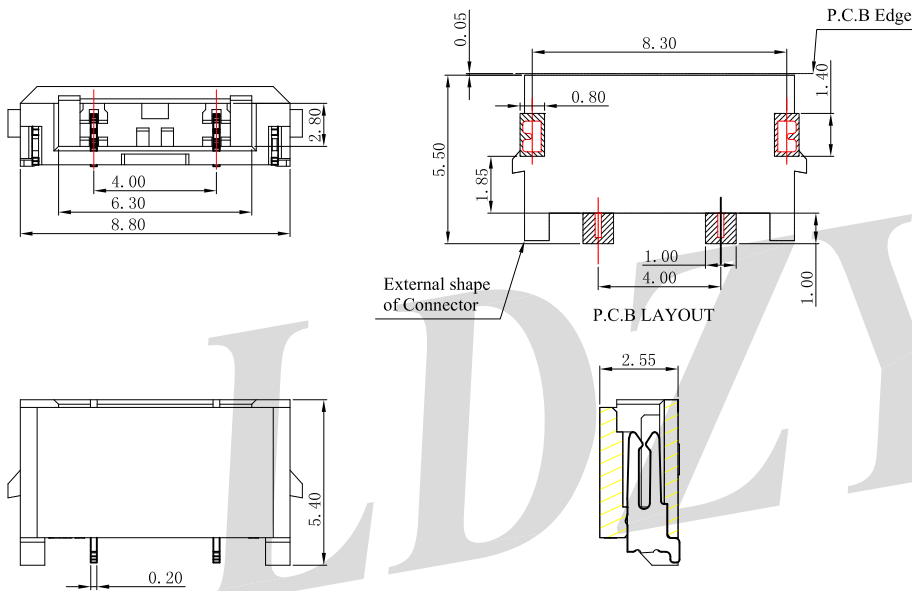

**Reference Informations:**

**\*Material:**

Pin: Phosphor bronze/Tin-plated  
Solder Tabs: Phosphor bronze/Tin-plated  
Wafer: LCP,UL94V-0 / Natrual

**\*Suitable LDZY B4000WRFS series Wafer**

**B4000WRFS-02-L0NAT**

4.00mm Pitch 90° SMT Single Row Wafer

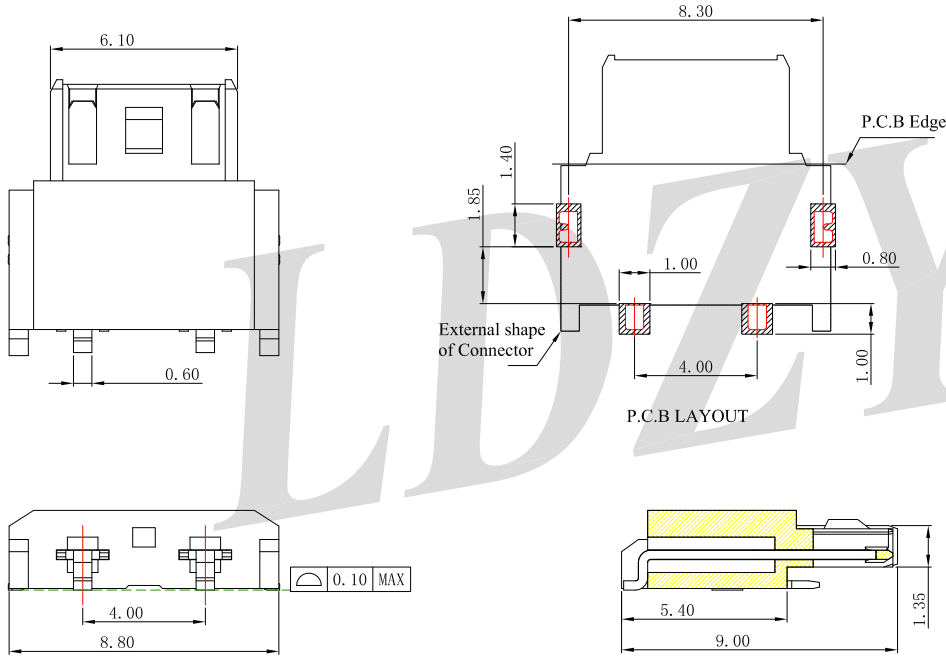

Reference Informations:

- \*Material:
- Pin: Phosphor bronze/Tin-plated
- Solder Tabs: Phosphor bronze/Tin-plated
- Wafer: LCP,UL94V-0 / Natrual
- \*Suitable LDZY B4000WRMS series Wafer