

SPECIFICATION FOR APPROVAL

CUSTOMER :	DATE :
PART NO : LFU09V-183	DWG.NO : HX1210119
CUSTOMER PART NO :	CUST.DWG.NO :

(1) UNIT: mm

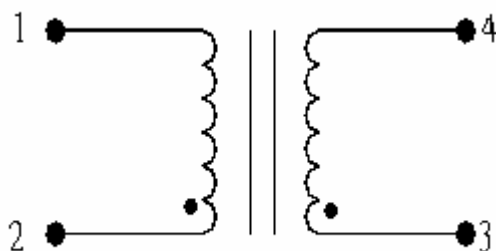

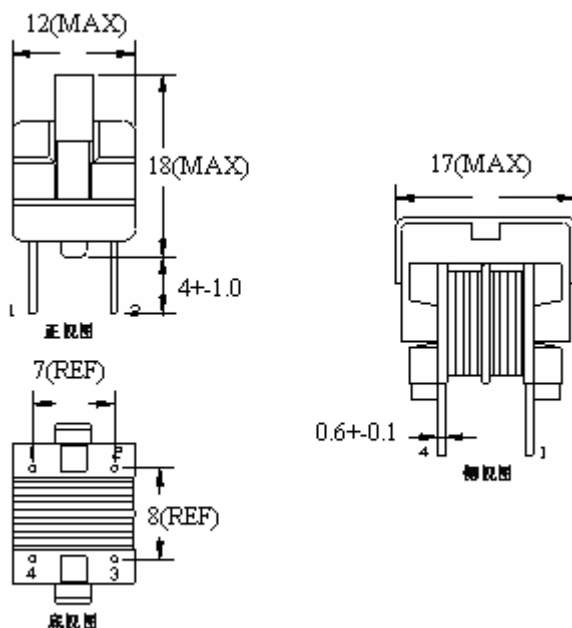

DRAWN BY <div style="text-align: center;">黄慧珍</div>	CHECKED BY <div style="text-align: center;">张明德</div>	APPROVED BY <div style="text-align: center;">张敏</div>
--------------------------------------------------------	----------------------------------------------------------	----------------------------------------------------------

CORE MASTER ENTERPRISE CO., LTD.

TEL:886-2-8919-1288 FAX:886-2-8919-1298 WEB:www.coremaster.com.tw

SPECIFICATION FOR APPROVAL

CUSTOMER :		DATE :	
PART NO : LFU09V-183		DWG.NO : HX1210119	
CUSTOMER PART NO :		CUST.DWG.NO :	
PARAMETER	TERMINAL	SPECIFICATION	TEST INSTRUMENTS
INDUCTANCE	L (2-1)=(3-4)	18mH (MIN)	1KHz/0.25V
DCR:	DCR (2-1)=(3-4)	0.3Ω (MAX)	
IDC	IDC (2-1)=(3-4)	0.5A (MAX)	
HI-POT	PIN1-PIN4	AC 1.5KV/5mA/3SEC	
	PIN1,4-CORE	AC 1.0KV/5mA/3SEC	
MATERIAL	SPEC	SUPPLIER	REMARK
CORE	UU9.8 R10K		
WIRE	2UEWφ 0.25 NTL 130℃		
WINDING	90TS(REF)		
BOBBIN	UU9.8 , 2+2PIN, 帶鋼夾,PLENOLIC		
DRAWN BY		CHECKED BY	APPROVED BY
			



CORE MASTER ENTERPRISE CO., LTD.

TEL:886-2-8919-1288

FAX:886-2-8919-1298

WEB:www.coremaster.com.tw

SPECIFICATION FOR APPROVAL

CUSTOMER :			DATE :		
PART NO : LFU09V-183			DWG.NO : HX1210119		
CUSTOMER PART NO :			CUST.DWG.NO :		
繞組	START	END	WIRE SIZE	TURNS(TS)	TAPE(TS)
N1	2	1	Φ0.25×1P	90(REF)	
N2	3	4	Φ0.25×1P	90(REF)	
DRAWN BY 			CHECKED BY 		APPROVED BY 

CORE MASTER ENTERPRISE CO., LTD.

TEL:886-2-8919-1288 FAX:886-2-8919-1298 WEB:www.coremaster.com.tw