

FGW40N65WE

Discrete IGBT (High-Speed W series) 650V / 40A

Features

- Low power loss
- Low switching surge and noise
- High reliability, high ruggedness (RBSOA, SCSOA etc.)

Applications

- Uninterruptible power supply
- PV Power conditioner
- Inverter welding machine

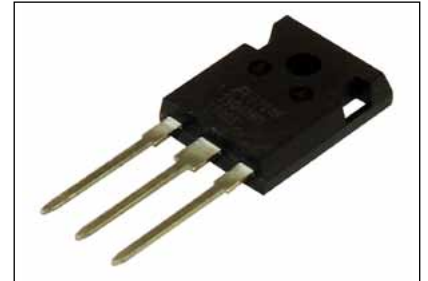

Maximum Ratings and Characteristics

Absolute Maximum Ratings at T_J=25°C (unless otherwise specified)

Items	Symbols	Characteristics	Unit	Remarks
Collector-Emitter Voltage	V _{CEs}	650	V	
Gate-Emitter Voltage	V _{GES}	±20	V	T _p <1μs
Transient Gate-Emitter Voltage		±30		
DC Collector Current	I _{C@25}	56	A	T _c =25°C
	I _{C@100}	40	A	T _c =100°C
Pulsed Collector Current	I _{CP}	160	A	Note *1
Turn-Off Safe Operating Area	-	160	A	V _{CE} ≤650V T _J ≤175°C
Diode Forward Current	I _{F@25}	61	A	
	I _{F@100}	40	A	
Diode Pulsed Current	I _{FP}	160	A	Note *1
IGBT Max. Power Dissipation	P _{D_IGBT}	260	W	T _c =25°C
FWD Max. Power Dissipation	P _{D_FWD}	155	W	T _c =25°C
Operating Junction Temperature	T _J	-40 ~ +175	°C	
Storage Temperature	T _{stg}	-55 ~ +175	°C	

Note *1 : Pulse width limited by T_{Jmax}.

Equivalent circuit

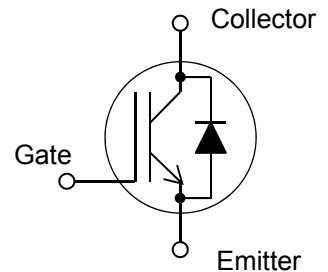

Electrical characteristics at T_J = 25°C (unless otherwise specified) Static Characteristics

Description	Symbol	Conditions	min.	typ.	max.	Unit.
Zero Gate Voltage Collector Current	I _{CES}	V _{CE} = 650V, V _{GE} = 0V	-	-	250	μA
Gate-Emitter Leakage Current	I _{GES}	V _{CE} = 0V, V _{GE} = ±20V	-	-	200	nA
Gate-Emitter Threshold Voltage	V _{GE(th)}	V _{CE} = 20V, I _c = 40mA	3.0	4.0	5.0	V
Collector-Emitter Saturation Voltage	V _{CE(sat)}	V _{GE} = 15V, I _c = 40A	-	1.80	2.20	V
Input Capacitance	C _{ies}	V _{CE} =25V	-	3000	-	pF
Output Capacitance	C _{oes}	V _{GE} =0V	-	85	-	
Reverse Transfer Capacitance	C _{res}	f=1MHz	-	64	-	
Gate Charge	Q _G	V _{CC} = 520V I _c = 40A V _{GE} = 15V	-	180	-	nC
Turn-On Delay Time	t _{d(on)}	T _J = 25°C, V _{CC} = 400V I _c = 20A, V _{GE} = 15V R _G = 10Ω, L = 500μH	-	24	-	ns
Rise Time	t _r		-	30	-	
Turn-Off Delay Time	t _{d(off)}		-	185	-	
Fall Time	t _f		-	47	-	
Turn-On Energy	E _{on}	Energy loss include "tail" and FWD reverse recovery.	-	0.29	-	mJ
Turn-Off Energy	E _{off}		-	0.29	-	
Turn-On Delay Time	t _{d(on)}	T _J = 150°C, V _{CC} = 400V I _c = 20A, V _{GE} = 15V R _G = 10Ω, L = 500μH	-	24	-	ns
Rise Time	t _r		-	30	-	
Turn-Off Delay Time	t _{d(off)}		-	215	-	
Fall Time	t _f		-	40	-	
Turn-On Energy	E _{on}	Energy loss include "tail" and FWD reverse recovery.	-	0.56	-	mJ
Turn-Off Energy	E _{off}		-	0.32	-	
Forward Voltage Drop	V _F	I _F =40A	-	2.5	3.2	V
			-	1.9	-	V
			-	1.7	-	V
Diode Reverse Recovery Time	t _{rr}	V _{CC} =400V, I _F =20A	-	100	-	ns
Diode Reverse Recovery Charge	Q _{rr}	-di _F /dt=500A/μs, T _J =25°C	-	0.29	-	μC
Diode Reverse Recovery Time	t _{rr}	V _{CC} =400V, I _F =20A	-	140	-	ns
Diode Reverse Recovery Charge	Q _{rr}	-di _F /dt=500A/μs, T _J =150°C	-	1.0	-	μC

● Thermal Resistance

Description	Symbol	min.	typ.	max.	Unit
Thermal Resistance, Junction-Ambient	$R_{th(j-a)}$	-	-	50	°C/W
Thermal Resistance, IGBT Junction to Case	$R_{th(j-c)}_{IGBT}$	-	-	0.572	°C/W
Thermal Resistance, FWD Junction to Case	$R_{th(j-c)}_{FWD}$	-	-	0.962	°C/W

Characteristics (Representative)

Graph.1
DC Collector Current vs Tc
V_{GE} ≥ +15V, T_j ≤ 175°C

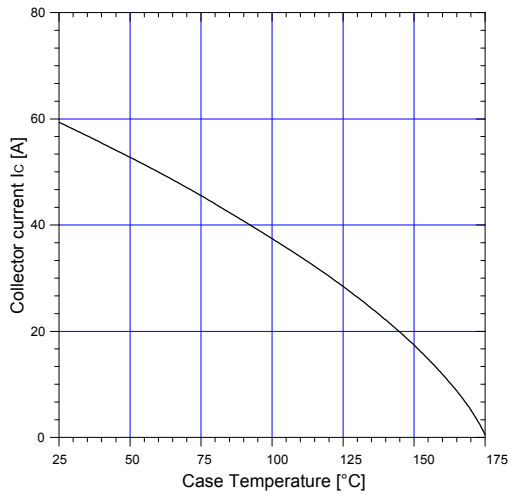

Graph.2
SOA
Duty=0(Single pulse), Tc=25°C

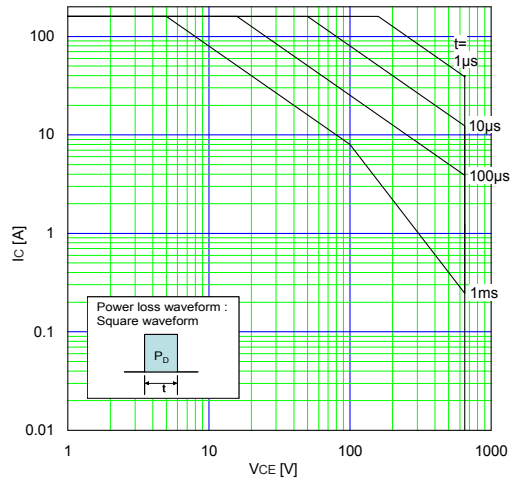

Graph.3
Typical Output Characteristics (V_{CE}-I_C)
T_j=25°C

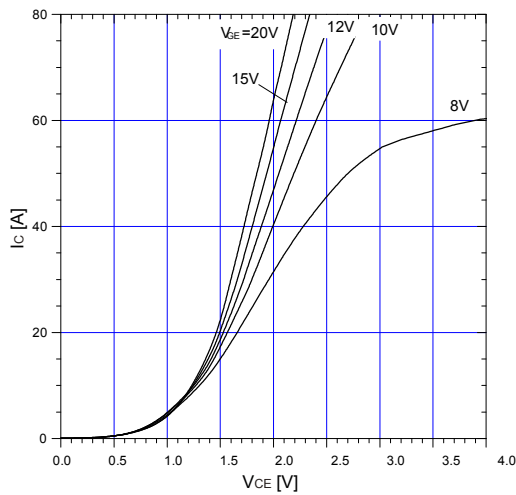

Graph.4
Typical Output Characteristics (V_{CE}-I_C)
T_j=175°C

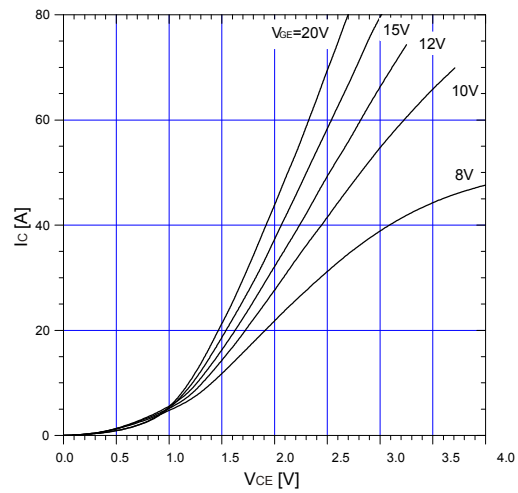

Graph.5
Typical Transfer Characteristics
V_{CE}=10V

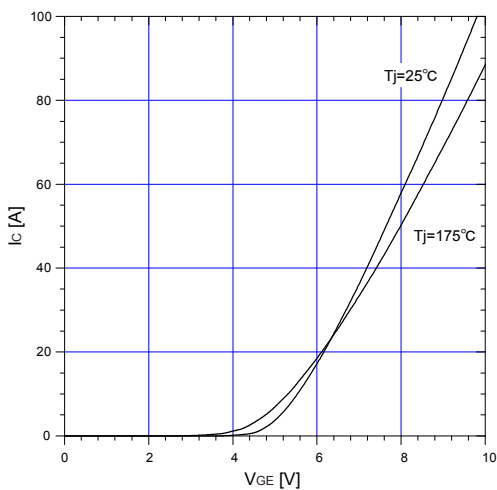

Graph.6
Gate Threshold Voltage vs. T_j
Ic=40mA, V_{CE}=20V

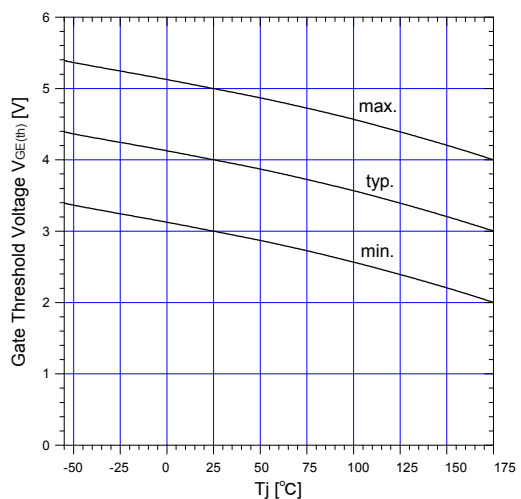

Graph.7
Typical Capacitance
 $V_{GE}=0V, f=1MHz, T_j=25^\circ C$

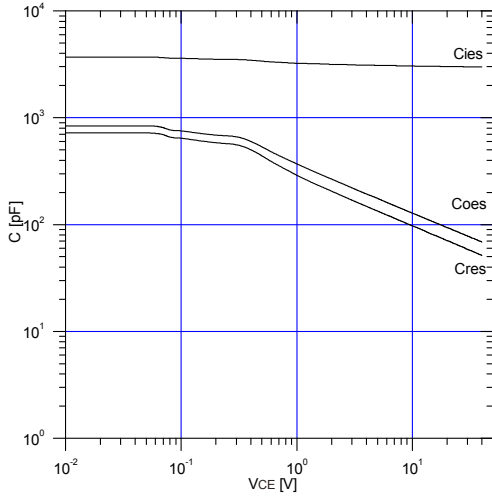

Graph.8
Typical Gate Charge
 $V_{cc}=520V, I_c=40A, T_j=25^\circ C$

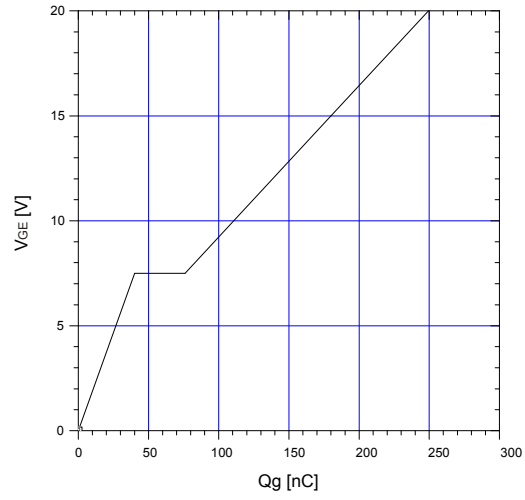

Graph.9
Typical switching time vs. I_c
 $T_j=150^\circ C, V_{cc}=400V, L=500\mu H$
 $V_{GE}=15V, R_G=10\Omega$

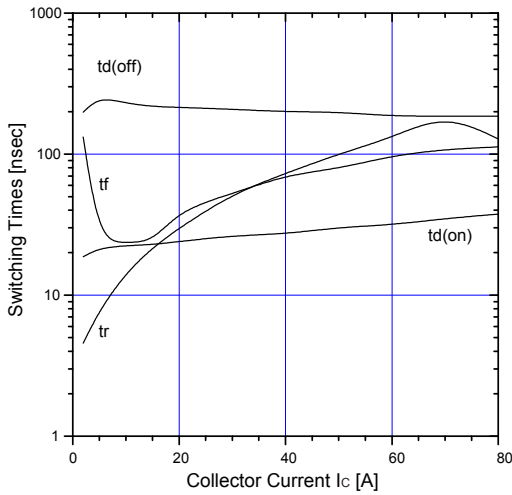

Graph.10
Typical switching time vs. R_g
 $T_j=150^\circ C, V_{cc}=400V, I_c=20A, L=500\mu H$
 $V_{GE}=15V$

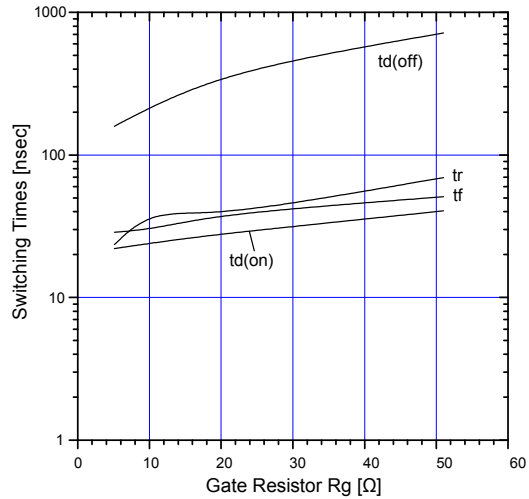

Graph.11
Typical switching losses vs. I_c
 $T_j=150^\circ C, V_{cc}=400V, L=500\mu H$
 $V_{GE}=15V, R_G=10\Omega$

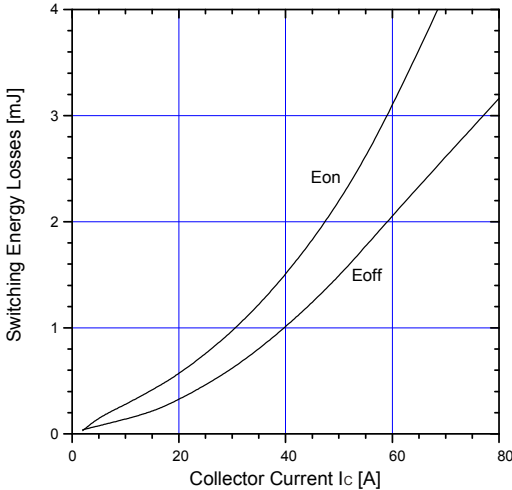

Graph.12
Typical switching losses vs. R_g
 $T_j=150^\circ C, V_{cc}=400V, I_c=20A, L=500\mu H$
 $V_{GE}=15V$

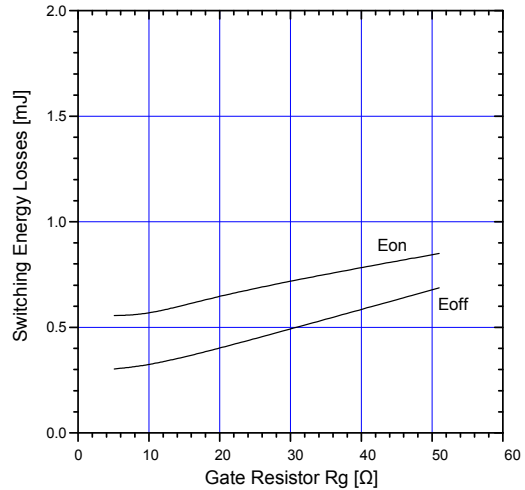

Graph.13
FWD Forward voltage drop (V_F - I_F)

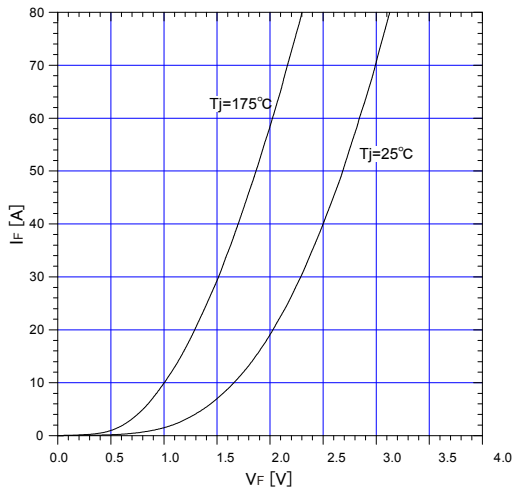

Graph.14
Typical reverse recovery characteristics vs. I_F
 $T_j=15^\circ\text{C}$, $V_{CC}=400\text{V}$, $L=500\mu\text{H}$
 $V_{GE}=15\text{V}$, $R_G=10\Omega$

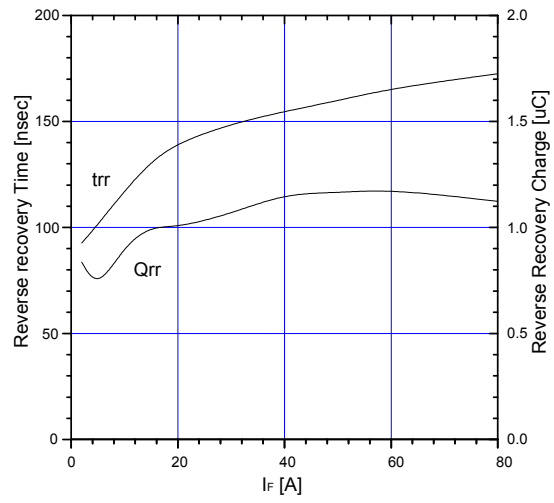

Graph.15
Typical reverse recovery loss vs. I_F
 $T_j=150^\circ\text{C}$, $V_{CC}=400\text{V}$, $L=500\mu\text{H}$
 $V_{GE}=15\text{V}$, $R_G=10\Omega$

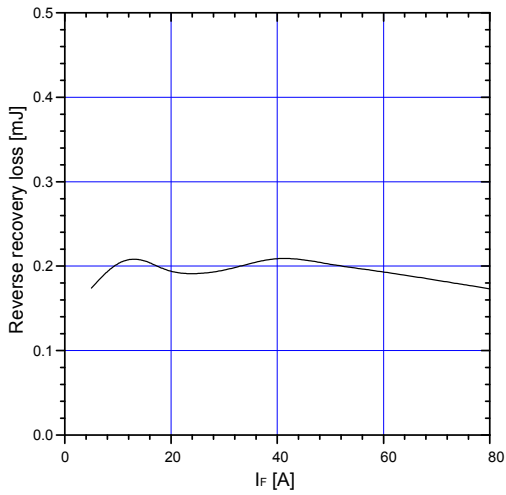

Graph.16
Reverse biased Safe Operating Area
 $T_j \leq 175^\circ\text{C}$, $V_{GE}=+15\text{V}/0\text{V}$, $R_G=10\Omega$

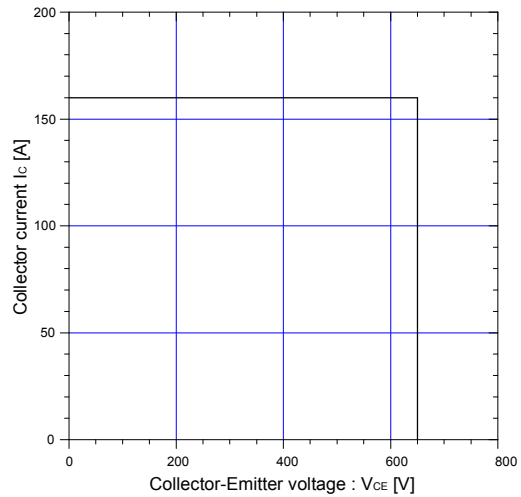

Graph.17
Transient thermal resistance of IGBT

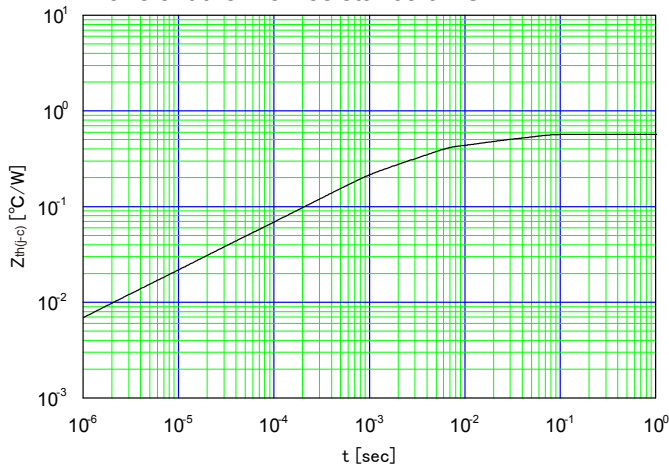

Graph.18
Transient thermal resistance of FWD

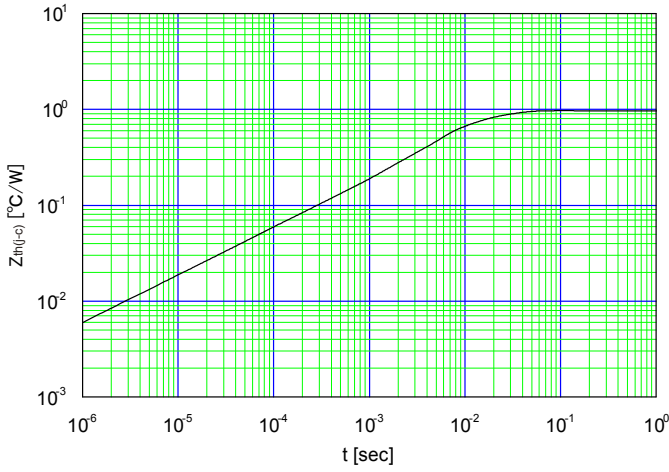

■ Outline Drawings, mm

Overview : TO-247 Package

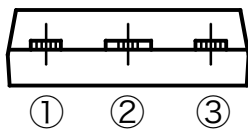
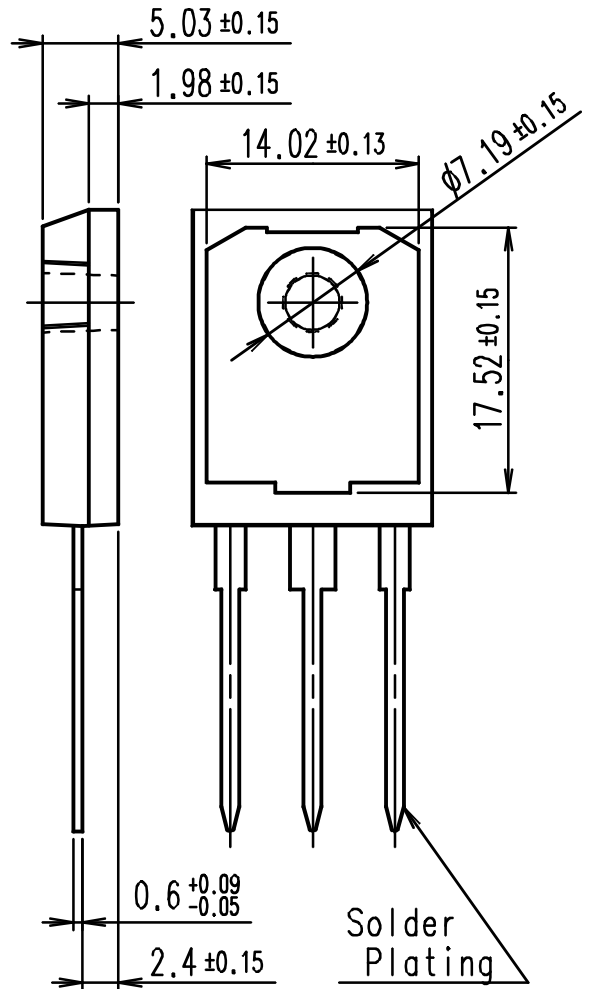
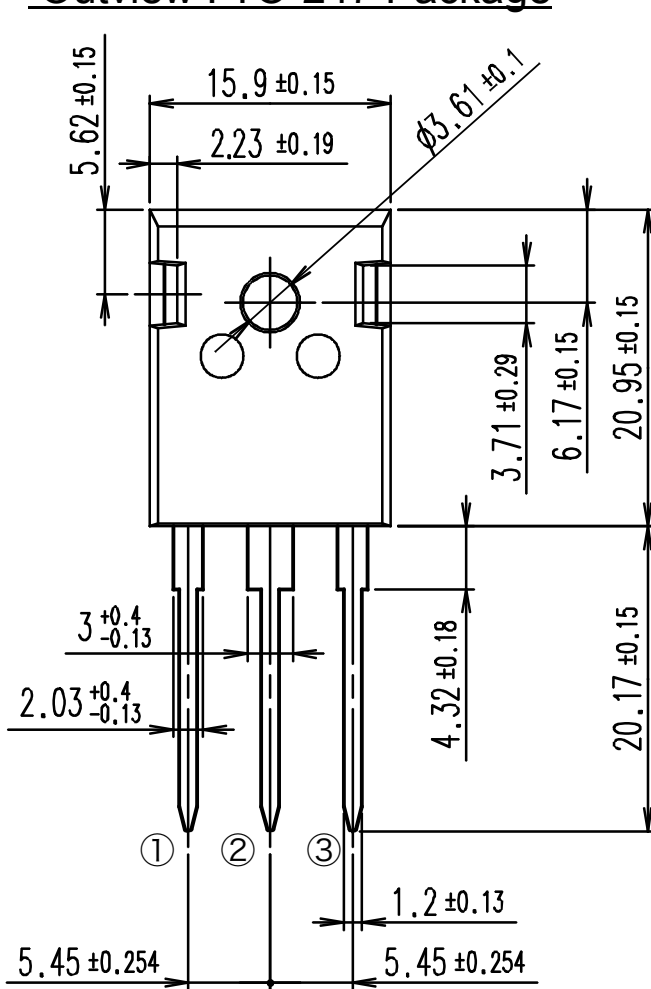

CONNECTION

- ① GATE
- ② COLLECTOR
- ③ EMITTER

DIMENSIONS ARE IN MILLIMETERS.

WARNING

1. This Catalog contains the product specifications, characteristics, data, materials, and structures as of September 2016. The contents are subject to change without notice for specification changes or other reasons. When using a product listed in this Catalog, be sure to obtain the latest specifications.
2. All applications described in this Catalog exemplify the use of Fuji's products for your reference only. No right or license, either express or implied, under any patent, copyright, trade secret or other intellectual property right owned by Fuji Electric Co., Ltd. is (or shall be deemed) granted. Fuji Electric Co., Ltd. makes no representation or warranty, whether express or implied, relating to the infringement or alleged infringement of other's intellectual property rights which may arise from the use of the applications described herein.
3. Although Fuji Electric Co., Ltd. is enhancing product quality and reliability, a small percentage of semiconductor products may become faulty. When using Fuji Electric semiconductor products in your equipment, you are requested to take adequate safety measures to prevent the equipment from causing a physical injury, fire, or other problem if any of the products become faulty. It is recommended to make your design failsafe, flame retardant, and free of malfunction.
4. The products introduced in this Catalog are intended for use in the following electronic and electrical equipment which has normal reliability requirements.
 - Computers
 - OA equipment
 - Communications equipment (terminal devices)
 - Measurement equipment
 - Machine tools
 - Audiovisual equipment
 - Electrical home appliances
 - Personal equipment
 - Industrial robots etc.
5. If you need to use a product in this Catalog for equipment requiring higher reliability than normal, such as for the equipment listed below, it is imperative to contact Fuji Electric Co., Ltd. to obtain prior approval. When using these products for such equipment, take adequate measures such as a backup system to prevent the equipment from malfunctioning even if a Fuji's product incorporated in the equipment becomes faulty.
 - Transportation equipment (mounted on cars and ships)
 - Trunk communications equipment
 - Traffic-signal control equipment
 - Gas leakage detectors with an auto-shut-off feature
 - Emergency equipment for responding to disasters and anti-burglary devices
 - Safety devices
 - Medical equipment
6. Do not use products in this Catalog for the equipment requiring strict reliability such as the following and equivalents to strategic equipment (without limitation).
 - Space equipment
 - Aeronautic equipment
 - Nuclear control equipment
 - Submarine repeater equipment
7. Copyright ©1996-2016 by Fuji Electric Co., Ltd. All rights reserved.
No part of this Catalog may be reproduced in any form or by any means without the express permission of Fuji Electric Co., Ltd.
8. If you have any question about any portion in this Catalog, ask Fuji Electric Co., Ltd. or its sales agents before using the product. Neither Fuji Electric Co., Ltd. nor its agents shall be liable for any injury caused by any use of the products not in accordance with instructions set forth herein.

Technical Information

IGBT Modules

- Please refer to URLs below for further information about products, application manuals and technical documents.
- 关于本规格书中没有记载的产品信息·应用手册·技术资料等·请参考以下链接。
- 本データシートに記載されていない製品情報，アプリケーションマニュアル，技術資料は以下の URL をご参照下さい。

FUJI ELECTRIC Power Semiconductor WEB site

日本	www.fujielectric.co.jp/products/semiconductor/
Global	www.fujielectric.com/products/semiconductor/
中国	www.fujielectric.com.cn/products/semiconductor/
Europe	www.fujielectric-europe.com/components/semiconductors/
North America	www.americas.fujielectric.com/components/semiconductors/

Information

日本

1 半導体総合カタログ	www.fujielectric.co.jp/products/semiconductor/catalog/
2 製品情報	www.fujielectric.co.jp/products/semiconductor/model/
3 アプリケーションマニュアル	www.fujielectric.co.jp/products/semiconductor/model/igbt/application/
4 技術資料	www.fujielectric.co.jp/products/semiconductor/model/igbt/technical/
5 マウンティングインストラクション	www.fujielectric.co.jp/products/semiconductor/model/igbt/mounting/
6 IGBT 損失シミュレーションソフト	www.fujielectric.co.jp/products/semiconductor/model/igbt/simulation/
7 AT-NPC 3-Level 損失シミュレーションソフト	www.fujielectric.co.jp/products/semiconductor/model/igbt/simulation_3level/
8 富士電機技報	www.fujielectric.co.jp/products/semiconductor/journal/
9 製品のお問い合わせ	www.fujielectric.co.jp/products/semiconductor/contact/
10 改廃のお知らせ	www.fujielectric.co.jp/products/semiconductor/discontinued/

Global

1 Semiconductors General Catalog	www.fujielectric.com/products/semiconductor/catalog/
2 Product Information	www.fujielectric.com/products/semiconductor/model/
3 Application Manuals	www.fujielectric.com/products/semiconductor/model/igbt/application/
4 Technical Documents	www.fujielectric.com/products/semiconductor/model/igbt/technical/
5 Mounting Instructions	www.fujielectric.com/products/semiconductor/model/igbt/mounting/
6 IGBT Loss Simulation Software	www.fujielectric.com/products/semiconductor/model/igbt/simulation/
7 AT-NPC 3-Level Loss Simulation Software	www.fujielectric.com/products/semiconductor/model/igbt/simulation_3level/
8 Fuji Electric Journal	www.fujielectric.com/products/semiconductor/journal/
9 Contact	www.fujielectric.com/products/semiconductor/contact/
10 Revised and discontinued product information	www.fujielectric.com/products/semiconductor/discontinued/

中国

1 半导体综合目录	www.fujielectric.com.cn/products/semiconductor/catalog/
2 产品信息	www.fujielectric.com.cn/products/semiconductor/model/
3 应用手册	www.fujielectric.com.cn/products/semiconductor/model/igbt/application/
4 技术资料	www.fujielectric.com.cn/products/semiconductor/model/igbt/technical/
5 安装说明书	www.fujielectric.com.cn/products/semiconductor/model/igbt/mounting/
6 IGBT 损耗模拟软件	www.fujielectric.com.cn/products/semiconductor/model/igbt/simulation/
7 AT-NPC 3-Level 损耗模拟软件	www.fujielectric.com.cn/products/semiconductor/model/igbt/simulation_3level/
8 富士电机技报	www.fujielectric.com.cn/products/semiconductor/journal/
9 产品咨询	www.fujielectric.com.cn/products/semiconductor/contact/
10 产品更改和停产信息	www.fujielectric.com.cn/products/semiconductor/discontinued/